

MATERIAL:

- 1、METAL PART: ZINC
- 2、PLASTIC PART: ABS
- 3、PLATING: NICKEL

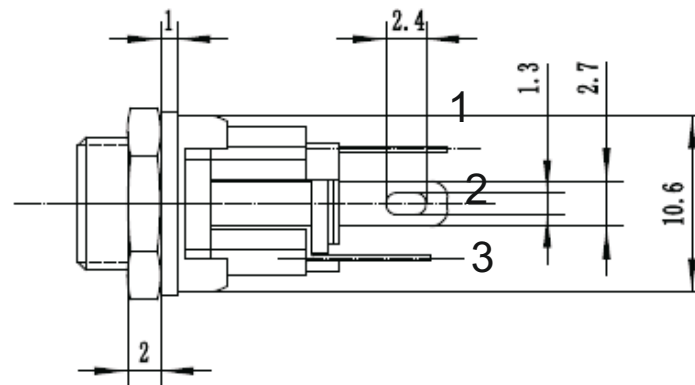

Distributed by Conrad Electronic SE • Klaus-Conrad-Str. 1 • D-92240 Hirschau

Datasheet

Item no. 001582319

V1_0617_02