

No.	Changes and/or Note No.	Date	Sign	No.	Changes and/or Note No.	Date	Sign

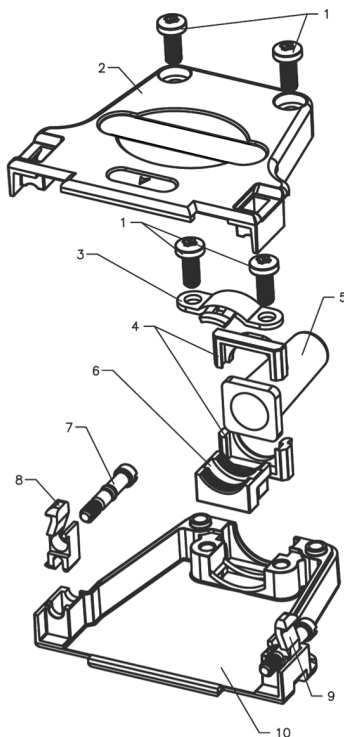

Part Number	Description	Pack	ITEM	PART NAME	Q'ty	NOTES
7960-0205-03	DTZF25-RG-K	Kit	1	SCREW M2.5*8	2	M2.5
			2	METAL HOOD-1	1	Zinc alloy
			3	SCREW M2.5*6	2	M2.5
			4	WASHER	1	
			5	SR	1	
7961-0205-03	DTZF25-RG	Bulk	6	STRAIN RELIEF	1	
			7	BOLT	2	UNC 4-40
			8	LATCH-1	1	
			9	LATCH-2	1	
			10	METAL HOOD-2	1	Zinc alloy

DATE 2013-06-13	DRAWN MRR	SCALE Free	MATERIAL TYPE	GENERAL TOLERANCE .X ±0.60 .X ±0.38 .XX ±0.25	ANGLE TOLERANCE .X ±5° .X ±3° .XX ±2°
	APPROVED		REPLACES		

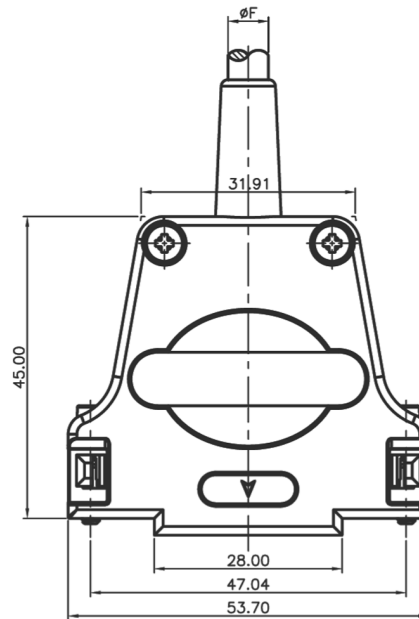
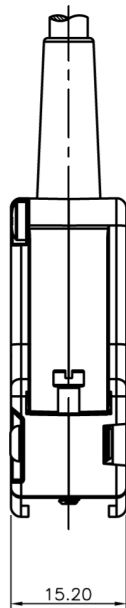

FULL METAL HOOD
DTZF25 - Series
Top Entry

DRAWING No.

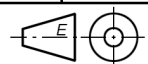

6688-9647