

# E43207

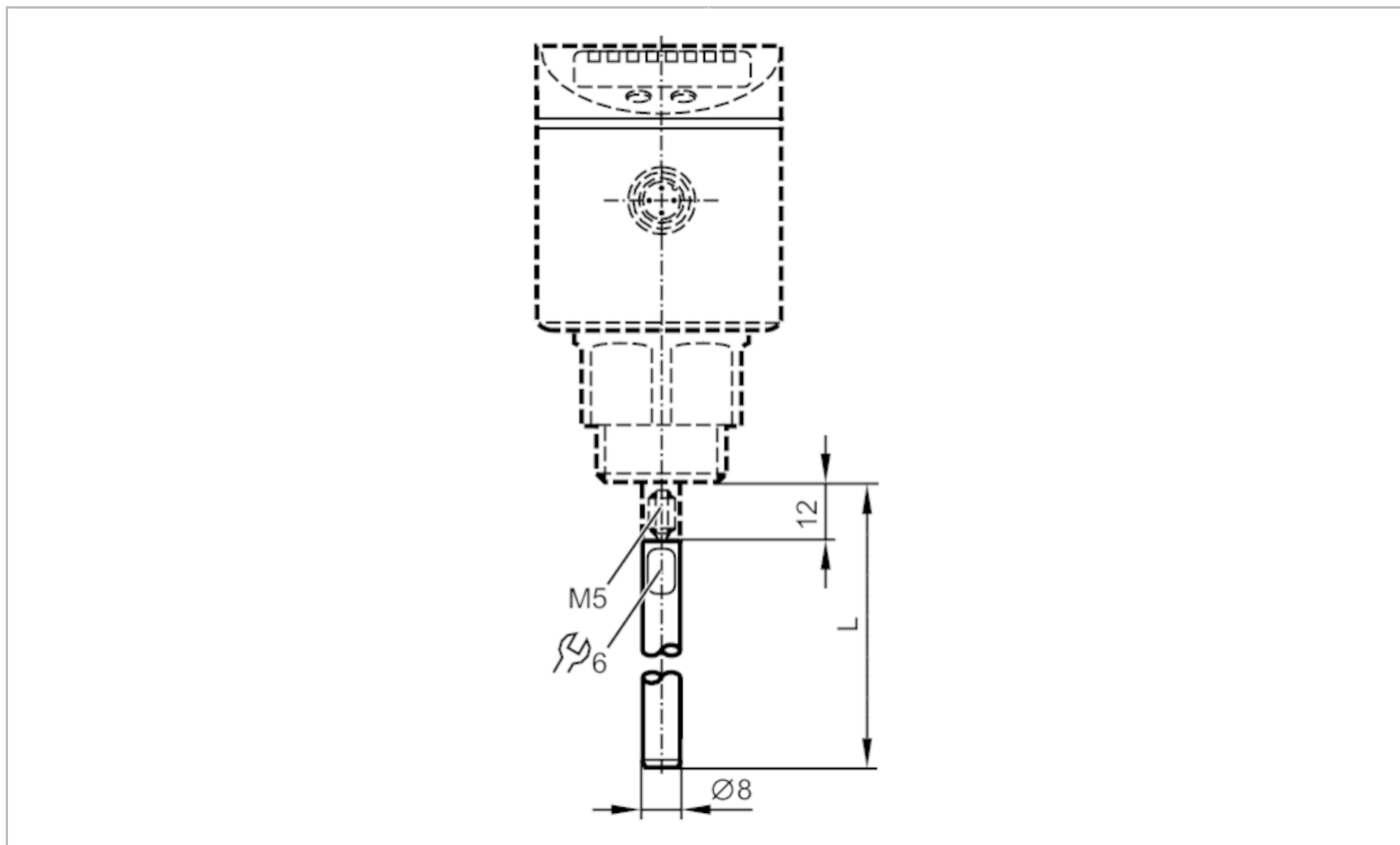

## Probe for level sensors

LR PROBE L1000



### Application

Design for level sensors LR

### Measuring/setting range

Probe length L [mm] 1000

### Mechanical data

Weight [g] 430

Materials stainless steel (1.4404 / 316L)

Tightening torque [Nm] 4

### Remarks

Pack quantity 1 pcs.