

Ultrasonic Sensor Transmitter

multicomp PRO



Applications:

- Burglar alarms
- Range finds
- Automatic doors
- Remote control

Features:

- Open structure and fission
- Compact and light weight
- High sensitivity and sound pressure
- Less power consumption
- High reliability

Technical Terms:

No	Item	Specification
1	Part Number	MCUST16P40B12RO
2	Construction	Open Structure
3	Using Method	Transmitter
4	Centre Frequency	40 ± 1kKz
5	Sound Pressure Level(at 40kHz) min. 110dB (10V/30cm)	-
6	Sensitivity at 40kHz	-
7	Capacitance	2,500pF ±25% at 1kHz
8	Directivity	50°
9	Operating Temperature Range	-35°C to +85°C
10	Storage Temperature Range	-35°C to +85°C
11	Detectable Range	0.7...18m
12	Housing Material	ABS

Ultrasonic Sensor Transmitter

multicomp^{PRO}

Drawing:

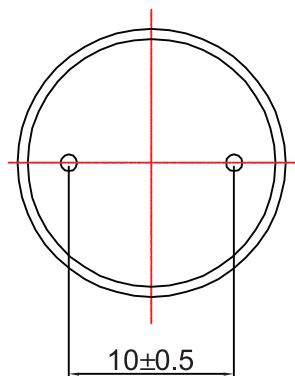
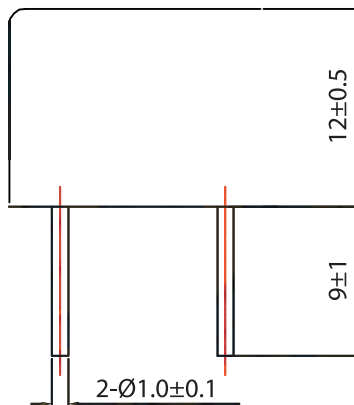
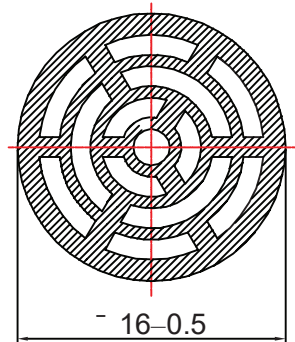

Dimensions : Millimetres

multicomp^{PRO}

Ultrasonic Sensor Transmitter

Beam Pattern:

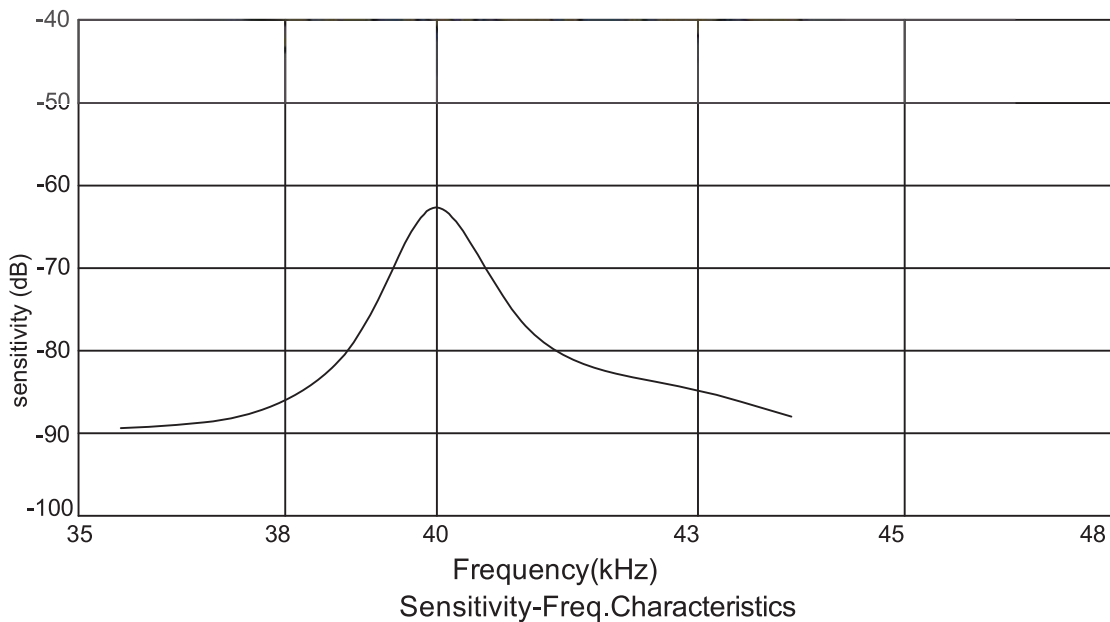
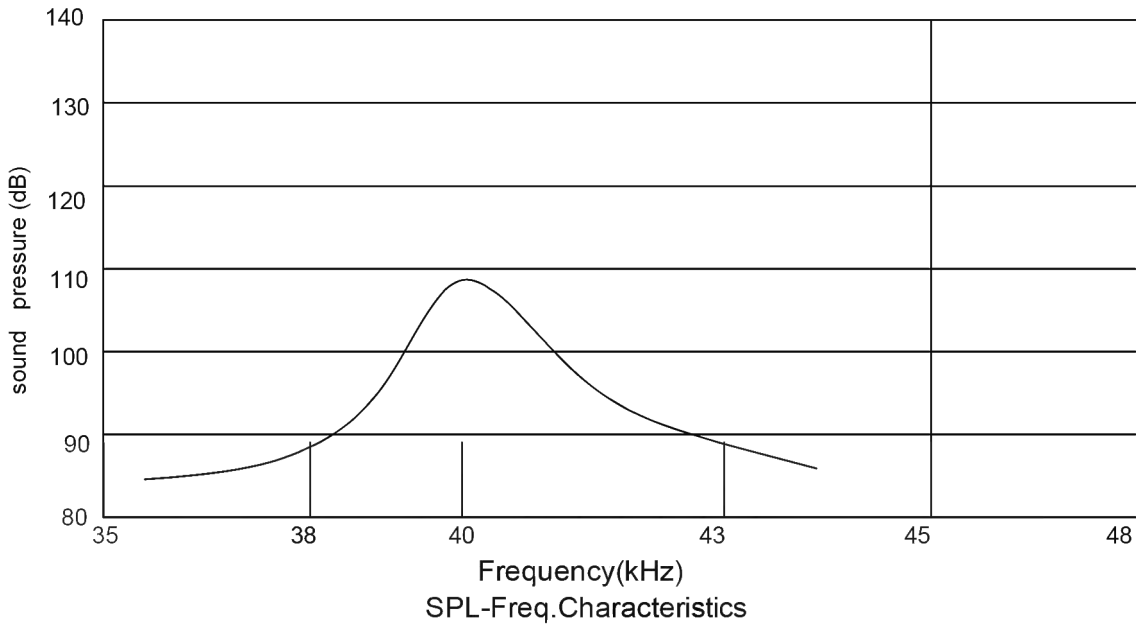

Ultrasonic Sensor Transmitter

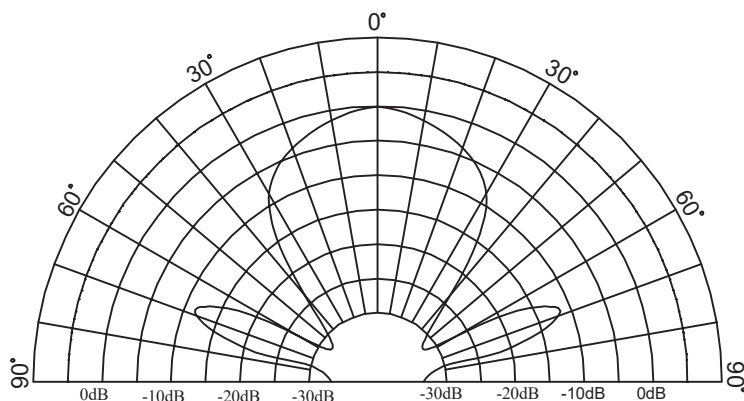

Directivity in OverallS ensitivity

Test Circuit:

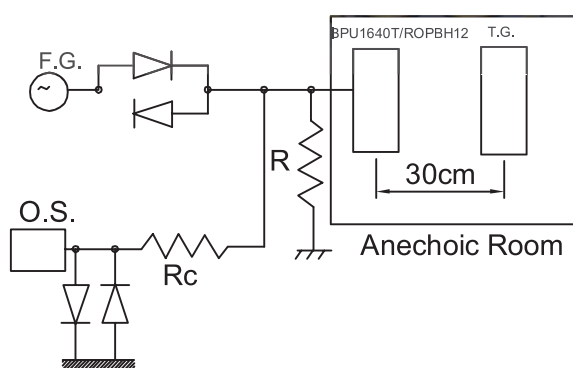

- R : 3.9kΩ Rc=1kΩ
- T.G. : Target
- F.G. : Function Generator
- O.S. : Oscilloscope

Part Number Table

Description	Part Number
Transmitter, 40kHz, 16mm, Plastic	MCUST16P40B12RO

Important Notice : This data sheet and its contents (the "Information") belong to the members of the AVNET group of companies (the "Group") or are licensed to it. No licence is granted for the use of it other than for information purposes in connection with the products to which it relates. No licence of any intellectual property rights is granted. The Information is subject to change without notice and replaces all data sheets previously supplied. The Information supplied is believed to be accurate but the Group assumes no responsibility for its accuracy or completeness, any error in or omission from it or for any use made of it. Users of this data sheet should check for themselves the Information and the suitability of the products for their purpose and not make any assumptions based on information included or omitted. Liability for loss or damage resulting from any reliance on the Information or use of it (including liability resulting from negligence or where the Group was aware of the possibility of such loss or damage arising) is excluded. This will not operate to limit or restrict the Group's liability for death or personal injury resulting from its negligence. Multicomp Pro is the registered trademark of Premier Farnell Limited 2019.