

Dialight

612 Series LED Panel Mount Indicators for 12mm Mounting Hole



FEATURES / BENEFITS

- ▲ RoHS Compliant
- ▲ Long Life - typically 100K hours
- ▲ Low power consumption - uses up to 90% less energy than an incandescent indicator
- ▲ No heat generated
- ▲ Colors include red, green and yellow
- ▲ Front panel mounting

APPLICATIONS

Dialight's 600 series of metric indicators are designed for a variety of applications such as:

- Main and remote power indication
- Status Indication
- Maintenance and warning indication
- Instrumentation
- ...and many more!

SPECIFICATIONS

- ▲ Voltage requirements: 6, 12 and 24 VDC (No limiting resistor required)
- ▲ Electrical connection through solder terminals
- ▲ Mounting hole size: 0.492 inches (12.5 mm)
- ▲ Maximum panel thickness: 0.236 inches (6.3 mm)
- ▲ Mounts with lock washer and nut (0.217 lbs/ft or 3 Kg/cm torque recommended)
- ▲ Operating Temperature : -25°C to +85°C
- ▲ Storage Temperature: -25°C to +100°C
- ▲ Housing Material: Polycarbonate
- ▲ Lens Material: Polycarbonate to match emitting color

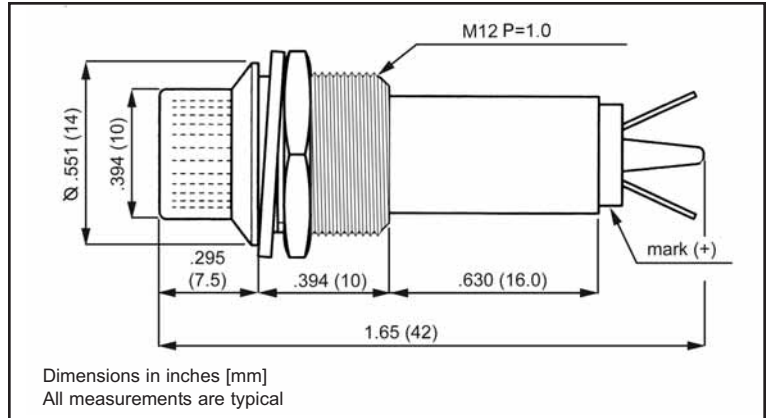

Part Number	Color	Voltage (VDC)	Current (mA)	Typ. Intensity (mcd)	RoHS Compliant
612-3132-120F	Red	6	15	60	✓
612-3232-120F	Green	6	15	110	✓
612-3332-120F	Yellow	6	15	90	✓
612-3132-130F	Red	12	15	60	✓
612-3232-130F	Green	12	15	110	✓
612-3332-130F	Yellow	12	15	90	✓
612-3132-140F	Red	24	15	60	✓
612-3232-140F	Green	24	15	110	✓
612-3332-140F	Yellow	24	15	90	✓

Dialight reserves the right to make changes at any time in order to supply the best product possible.

Dialight Corporation

1501 Route 34 South • Farmingdale, NJ 07727 USA

Tel: (1) 732-919-3119 • Fax: (1) 732-751-5778 • www.dialight.com



MDEL612X001_B