



finder[®]
SWITCH TO THE FUTURE

Line monitoring relay

70
SERIES



Air
conditioners



Wood-
processing
machines



Hoists and
cranes



Escalators



Control panels
for pumps



Forced-air
ventilators

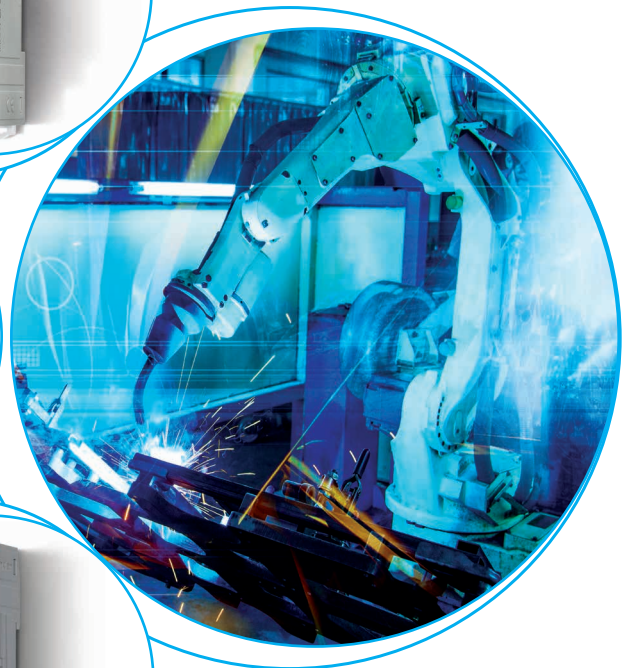

Electronic voltage monitoring relays for single and three-phase applications

- Multifunctional types, providing the flexibility of monitoring Undervoltage, Overvoltage, Window Mode, Phase rotation, Phase loss
- Positive safety logic - Make output contact opens if the relay detects an error
- All functions and values can be easily adjusted by the selector and trimmer on front face
- "Blade + cross" – both flat blade and cross head screw drivers can be used to adjust the regulators and the function selector
- Colored LEDs for clear & immediate visual indication
- 1 CO relay output, 6 or 10 A
- Modular housing, 17.5 or 35 mm wide
- 35 mm rail (EN 60715) mount
- Cd-free contact material

Screw terminal



For outline drawing see page 12

Contact specification

Contact configuration		1 CO (SPDT)	1 CO (SPDT)
Rated current/Maximum peak current	A	10/30	6/10
Rated voltage/ Max. switching voltage	V AC	250/400	250/400
Rated load AC1	VA	2500	1500
Rated load AC15	VA	750	500
Single phase motor rating (230 V AC)	kW	0.5	0.185
Breaking capacity DC1: 30/110/220 V	A	10/0.3/0.12	6/0.2/0.12
Minimum switching load	mW (V/mA)	300 (5/5)	500 (12/10)
Standard contact material		AgNi	AgNi

Supply specification

Nominal system voltage (U _N)	V AC (50/60 Hz)	220...240	380...415
Rated power	VA (50 Hz)/W	2.6/0.8	11/0.9
Operating range	V AC (50/60 Hz)	130...280	220...510

Technical data

Electrical life at rated load AC1	cycles	80 · 10 ³	60 · 10 ³
Voltage detection level range	V	170...270	300...480
Asymmetry detection level range	%	—	—
Switch-off delay time (T on function diagrams)	s	0.5...60	0.5...60
Switch-on lock-out time	s	0.5	1
Switch-on hysteresis (H on function diagrams)	V	5 (L-N)	10 (L-L)
Power-on activation time	s	≈ 1	≈ 1
Insulation between supply and contacts (1.2/50 μs)	kV	4	4
Dielectric strength between open contacts	V AC	1000	1000
Ambient temperature	°C	-20...+60	-20...+60
Protection category		IP 20	IP 20

Approvals (according to type)



70.11



Single-phase (220...240)V voltage monitoring:

- Undervoltage
- Overvoltage
- Window mode (overvoltage + undervoltage)
- Voltage fault memory selectable

70.31



Three-phase (380...415)V voltage monitoring:

- Undervoltage
- Overvoltage
- Window mode (overvoltage + undervoltage)
- Voltage fault memory selectable
- Phase loss, even under phase regeneration
- Phase rotation

Electronic voltage monitoring relays for three-phase applications

- Multifunctional types, providing the flexibility of monitoring Undervoltage, Overvoltage, Window Mode, Phase rotation, Phase loss, Asymmetry and Neutral loss
- Phase loss monitoring, even under phase regeneration
- Positive safety logic - Make output contact opens if the relay detects an error
- All functions and values can be easily adjusted by the selector and trimmer on front face
- "Blade + cross" – both flat blade and cross head screw drivers can be used to adjust the regulators and the function selector
- Colored LEDs for clear & immediate visual indication
- 1 or 2 CO relay output, 6 or 8 A
- Modular housing, 35 mm wide
- 35 mm rail (EN 60715) mount
- Cd-free contact material

Screw terminal



For outline drawing see page 12

Contact specification

		70.41	70.42
Contact configuration		1 CO (SPDT)	2 CO (DPDT)
Rated current/Maximum peak current	A	6/10	8/15
Rated voltage/ Max. switching voltage	V AC	250/400	250/400
Rated load AC1	VA	1500	2000
Rated load AC15	VA	500	400
Single phase motor rating (230 V AC)	kW	0.185	0.3
Breaking capacity DC1: 30/110/220 V	A	6/0.2/0.12	8/0.3/0.12
Minimum switching load	mW (V/mA)	500 (12/10)	300 (5/5)
Standard contact material		AgNi	AgNi

Supply specification

		70.41	70.42
Nominal system voltage (U_N)	V AC (50/60 Hz)	380...415	380...415
Rated power	VA (50 Hz)/W	11/0.9	12.5/1
Operating range	V AC (50/60 Hz)	220...510	220...510

Technical data

		70.41	70.42
Electrical life at rated load AC1	cycles	$60 \cdot 10^3$	$60 \cdot 10^3$
Voltage detection level range	V	300...480	300...480
Asymmetry detection level range	%	4...25	5...25
Switch-off delay time (T on function diagrams)	s	0.5...60	0.5...60
Switch-on lock-out time	s	1	1
Switch-on hysteresis (H on function diagrams)	V	10 (L-L)	10 (L-L)
Power-on activation time	s	≈ 1	≈ 1
Insulation between supply and contacts (1.2/50 μ s)	kV	4	4
Dielectric strength between open contacts	V AC	1000	1000
Ambient temperature	$^{\circ}$ C	-20...+60	-20...+60
Protection category		IP 20	IP 20

Approvals (according to type)

70.41

Three-phase (380...415 V, with or without neutral) voltage monitoring:

- Window mode (overvoltage + undervoltage)
- Phase loss
- Phase rotation
- Asymmetry
- Neutral loss selectable

70.42

Three-phase (380...415 V, with neutral) voltage monitoring:

- Undervoltage
- Overvoltage
- Window mode (overvoltage + undervoltage)
- Voltage fault memory selectable
- Phase loss
- Phase rotation
- Asymmetry
- Neutral loss

Electronic phase loss and rotation monitoring relays for three-phase applications

- Universal voltage monitoring (U_N from 208 V to 480 V, 50/60 Hz)
- Phase loss monitoring, even under phase regeneration
- Positive safety logic - Make contact opens if the relay detects an error
- 2 versions:
1 CO relay output, 6 A (17.5 mm wide), and
2 CO relay output, 8 A (22.5 mm wide)
- 35 mm rail (EN 60715) mount
- European patent pending for the innovative principle at the root of the 3 phase monitoring and error survey system (70.61)

Screw terminal



For outline drawing see page 12

Contact specification

Contact configuration		1 CO (SPDT)	2 CO (DPDT)
Rated current/Maximum peak current	A	6/15	8/15
Rated voltage/ Max. switching voltage	V AC	250/400	250/400
Rated load AC1	VA	1500	2000
Rated load AC15	VA	250	400
Single phase motor rating (230 V AC)	kW	0.185	0.3
Breaking capacity DC1: 30/110/220 V	A	3/0.35/0.2	8/0.3/0.12
Minimum switching load	mW (V/mA)	500 (10/5)	300 (5/5)
Standard contact material		AgSnO ₂	AgNi

Supply specification

Nominal system voltage (U_N)	V AC (50/60 Hz)	208...480	208...480
Rated power	VA (50 Hz)/W	8/1	11/0.8
Operating range	V AC (50/60 Hz)	170...500	170...520

Technical data

Electrical life at rated load AC1	cycles	100 · 10 ³	60 · 10 ³
Switch-off delay time	s	0.5	0.5
Switch-on lock-out time	s	0.5	0.5
Power-on activation time	s	< 2	< 2
Insulation between supply and contacts (1.2/50 μs)	kV	5	5
Dielectric strength between open contacts	V AC	1000	1000
Ambient temperature	°C	-20...+60	-20...+60
Protection category		IP 20	IP 20

Approvals (according to type)



70.61



Three-phase (208...480)V
voltage monitoring:

- Phase loss
- Phase rotation

70.62



Three-phase (208...480)V
voltage monitoring:

- Phase loss
- Phase rotation

Ordering information

Example: 70 series, three-phase voltage monitoring relay, 1 output, supply voltage 380...415 V AC.

70.31.8400.20.22

Series ————

Type ————
 1 = 1 phase AC line monitoring
 3 = 3 phase AC line monitoring
 4 = 3 phase + neutral AC line monitoring
 6 = 3 phase loss and rotation monitoring

No. of poles ————
 1 = 1 pole
 2 = 2 pole

Supply version ————
 8 = AC (50/60 Hz)

Supply voltage ————
 230 = 220...240 V (70.11)
 400 = 380...415 V (70.31/41/42)
 400 = 208...480 V (70.61/62)

D: Fault memory option
 0 = No fault memory
 2 = Fault memory function selectable

C: Time delay setting
 0 = Fixed switch-off delay
 2 = Adjustable switch-off delay
 3 = Adjustable switch-off delay and asymmetry

B: Contact circuit
 0 = CO

A: Detection values
 0 = Non-adjustable detection values
 2 = 2 adjustable detection values

Codes
 70.11.8.230.2022 70.42.8.400.2032
 70.31.8.400.2022 70.61.8.400.0000
 70.41.8.400.2030 70.62.8.400.0000

Monitoring and function overview

	70.11	70.31	70.41	70.42	70.61/62
Supply system type	Single phase system	3-phase systems	3-phase systems	3-phase systems	3-phase systems
Nominal voltage 50/60 Hz	V 220...240	380...415	380...415	380...415	208...480
Undervoltage with/without memory (selectable)	•	•	—	•	—
Overvoltage with/without memory (selectable)	•	•	—	•	—
Window Mode with/without memory (selectable)	•	•	—	•	—
Window Mode without memory	—	—	•	—	—
Phase loss	—	•	•	•	•
Phase rotation	—	•	•	•	•
Phase asymmetry	—	—	•	•	—
Neutral loss (selectable)	—	—	•	• (fixed)	—

Technical data

Insulation			70.11/31/41/42	70.61	70.62
Between supply and contacts	dielectric strength	V AC	2500	2500	3000
	impulse (1.2/50 µs)	kV	4	5	5
Between open contacts	dielectric strength	V AC	1000	1000	1000
	impulse (1.2/50 µs)	kV	1.5	1.5	1.5
EMC specifications					
Type of test		Reference standard			
Electrostatic discharge	contact discharge		EN 61000-4-2	4 kV	
	air discharge		EN 61000-4-2	8 kV	
Radiated electromagnetic field	80...1000 MHz		EN 61000-4-3	10 V/m	
	1...2.8 GHz		EN 61000-4-3	5 V/m	
Fast transients (burst 5/50 ns, 5 and 100 kHz)	on supply terminals		EN 61000-4-4	4 kV	
Voltage pulses on supply terminals (surge 1.2/50 µs)	common mode		EN 61000-4-5	4 kV	
	differential mode		EN 61000-4-5	4 kV	
Radiofrequency common mode voltage (0.15...230 MHz)	on supply terminals		EN 61000-4-6	10 V	
Voltage dips	70% U _N		EN 61000-4-11	25 cycles	
Short interruptions			EN 61000-4-11	1 cycle	
Radiofrequency conducted emissions	0.15...30 MHz		CISPR 11	class B	
Radiated emissions	30...1000 MHz		CISPR 11	class B	
Terminals			solid cable	stranded cable	
Max. wire size		mm ²	1 x 6 / 2 x 4	1 x 4 / 2 x 2.5	
		AWG	1 x 10 / 2 x 12	1 x 12 / 2 x 14	
 Screw torque		Nm	0.8		
Wire strip length		mm	9		
Other data			70.11	70.31/41	70.42/61/62
Power lost to the environment	without output current	W	0.8	0.9	1
	with rated output current	W	2	1.2	1.4

Functions

Output relay On (NO closed) when all OK: positive logic.

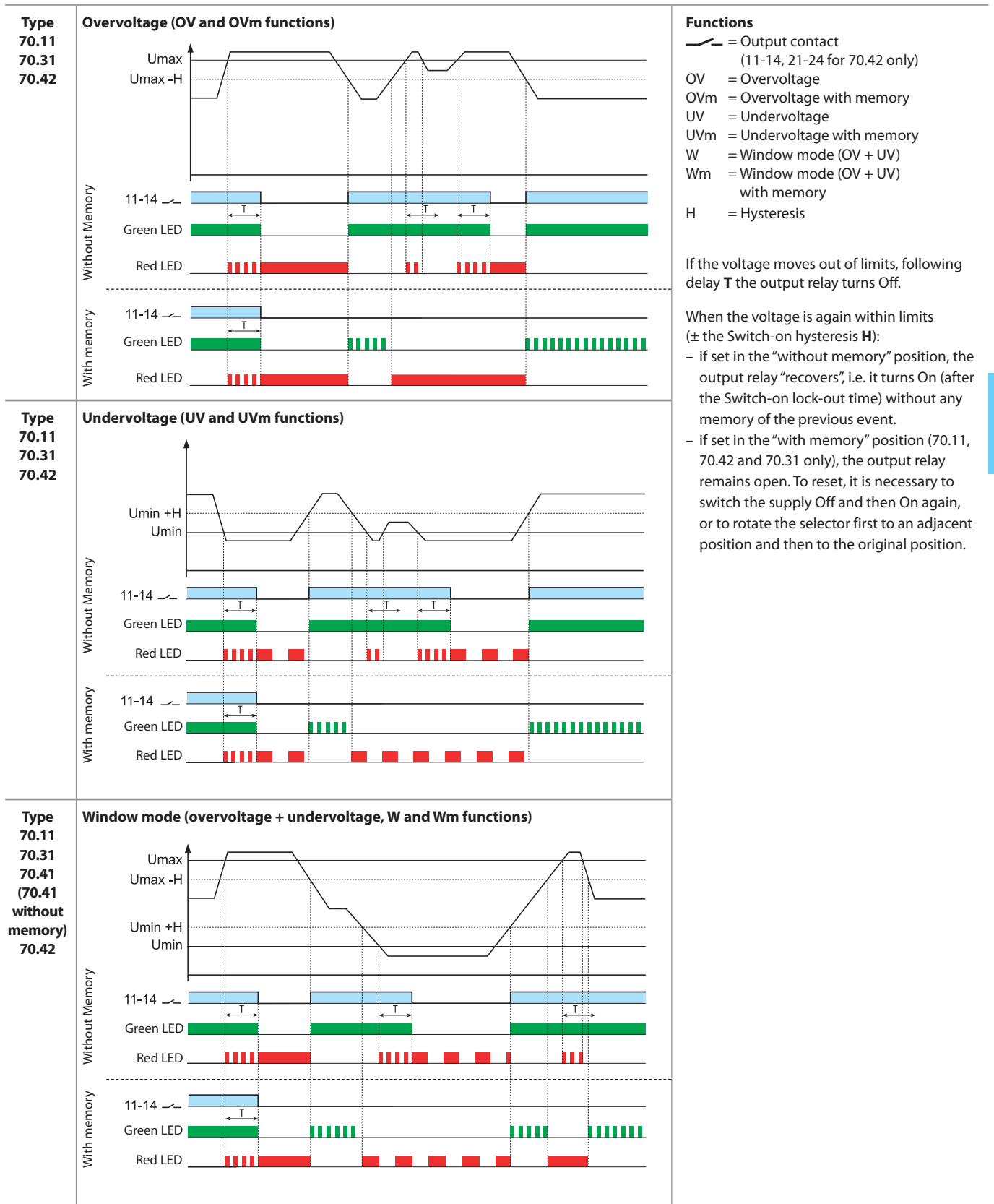

E

Functions

Output relay On (NO closed) when all OK: positive logic.

<p>Type 70.31 70.41 70.42 70.61 70.62</p>	<p>Phase loss and phase rotation</p>	<p>If the sequence (L1, L2, L3) is incorrect at power-on, the output relay will not turn-on.</p> <p>If a phase is lost, the output relay turns off immediately. When the phase is again active, the output relay turns on immediately.</p> <p>Phase loss monitoring possible even under regeneration up to 80% of the average of the other 2 phases.</p>
<p>E Type 70.41 70.42</p>	<p>Neutral loss and asymmetry</p>	<p>If the neutral is lost (and the Neutral control function is set), the output relay turns off immediately. When the neutral is again present, the output relay turns on immediately.</p> <p>If the asymmetry $(U_{max} - U_{min})/U_N$ is above the % set value, the output relay turns off after the set delay T. When the asymmetry is again below the % set value (with a fixed hysteresis of approximately 2%), the output relay turns on after the Switch-on lock-out time.</p>

Front view: function selector and regulators

<p>70.11</p> <p>Functions: OV, OVm, UV, UVm, W, Wm</p> <p>Toff delay: (0.5...60)sec</p> <p>U_{Max}: (220...270)V</p> <p>U_{Min}: (170...230)V</p>	<p>70.31</p> <p>Functions: OV, OVm, UV, UVm, W, Wm</p> <p>U_{Max}: (380...480)V</p> <p>U_{Min}: (300...400)V</p> <p>Toff delay: (0.5...60) sec</p>	<p>70.41</p> <p>N= With N-line monitoring N≠ Without N-line monitoring</p> <p>U_{Max}: (380...480)V</p> <p>(4...25)% U_N</p> <p>U_{Min}: (300...400)V</p> <p>Toff delay: (0.5...60)sec</p>
<p>70.42</p> <p>Functions: OV, OVm, UV, UVm, W, Wm</p> <p>U_{Max}: (380...480)V</p> <p>(5...25)% U_N</p> <p>U_{Min}: (300...400)V</p> <p>Toff delay: (0.5...60)sec</p>		

E

LED indication

Monitoring relay Type	LED	Supply system normal	Supply system abnormal (Voltage out of limits, switch-off delay time T running)	Supply system abnormal (Reason for switch-off, RESET necessary when "with Memory" is selected)
		Contact 11 - 14 closed	Contact 11 - 14 closed	Contact 11-14 open
70.11.8.230.2022	• •		 	Overvoltage OV and OVm Undervoltage UV and UVm With Memory, following a failure a manual "RESET" ** is necessary
70.31.8.400.2022	• • •		 	Overvoltage OV and OVm Undervoltage UV and UVm Phase loss Phase rotation With Memory, following a failure a manual "RESET" ** is necessary
70.41.8.400.2030	• • •		 	Overvoltage OV Undervoltage UV Asymmetry Phase loss Neutral loss Phase rotation
70.42.8.400.2032	• • •		 	Overvoltage OV and OVm Undervoltage UV and UVm Asymmetry Phase loss Neutral loss Phase rotation With Memory, following a failure a manual "RESET" ** is necessary
70.61.8.400.0000	•			Phase rotation or Phase loss
70.62.8.400.0000	•			Phase loss Phase rotation

* The function "with Memory" is only available for type 70.11, 70.42 and 70.31.

** It is necessary to switch the supply OFF and then On again (U off U on) or to rotate the function selector first to an adjacent position and then to the original position.

Wiring diagrams

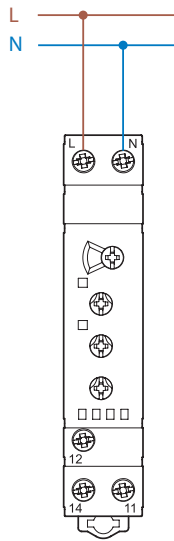

Type 70.11

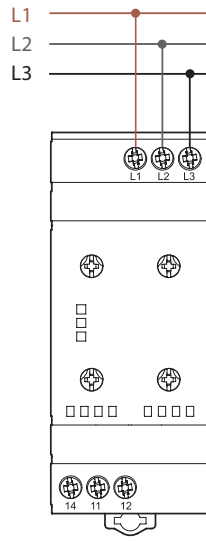

Type 70.31

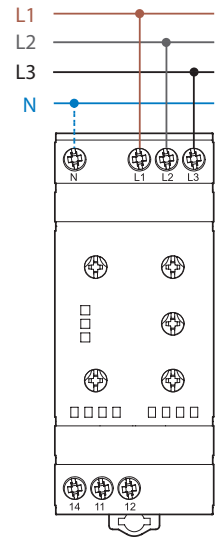

Type 70.41

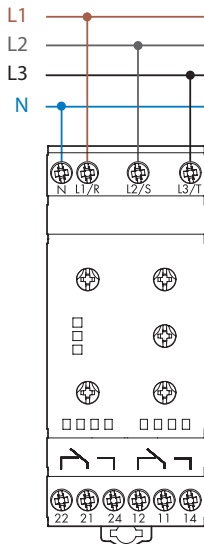

Type 70.42

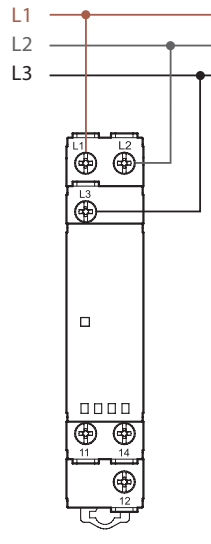

Type 70.61

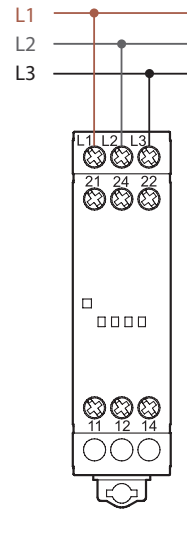

Type 70.62

E

Application example

The output contact switches the coil of the line contactor.

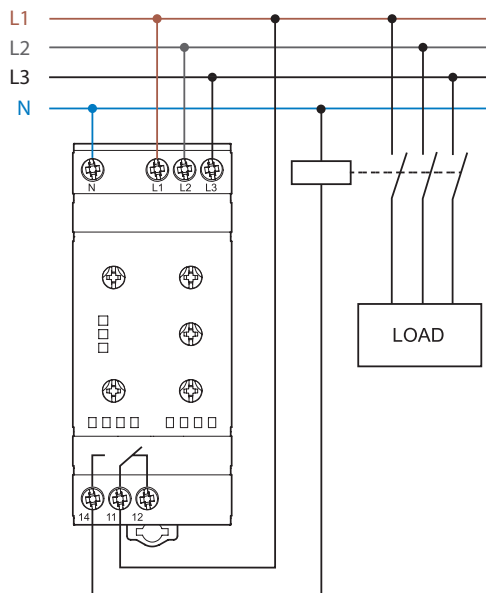

Outline drawings

Type 70.11
Screw terminal

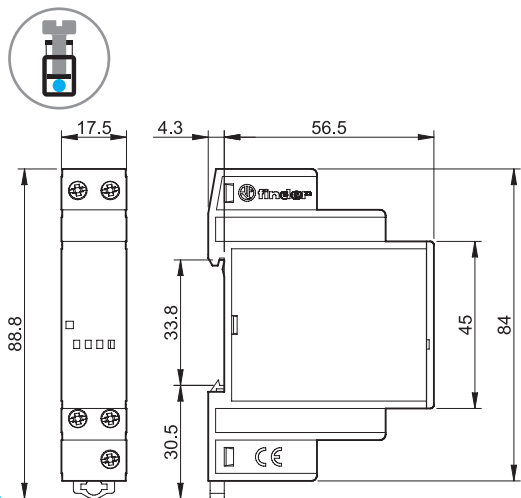

Type 70.31
Screw terminal

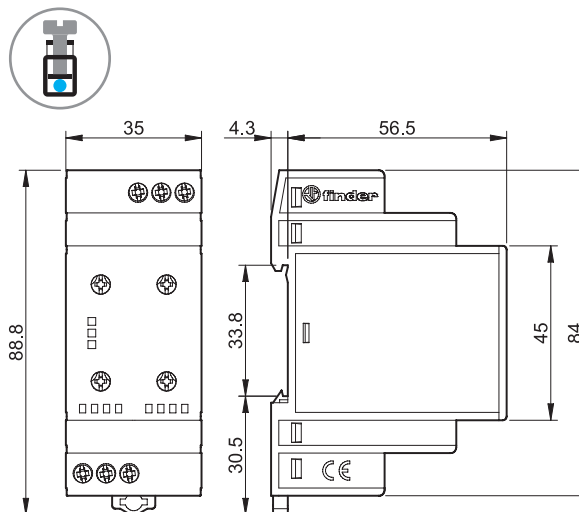

E Type 70.41
Screw terminal

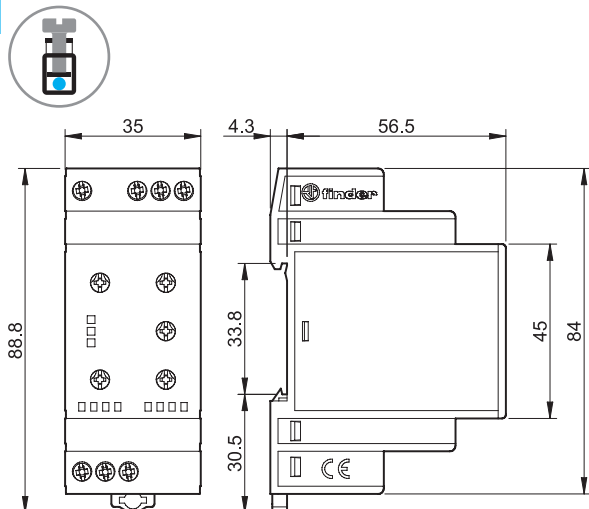

Type 70.42
Screw terminal

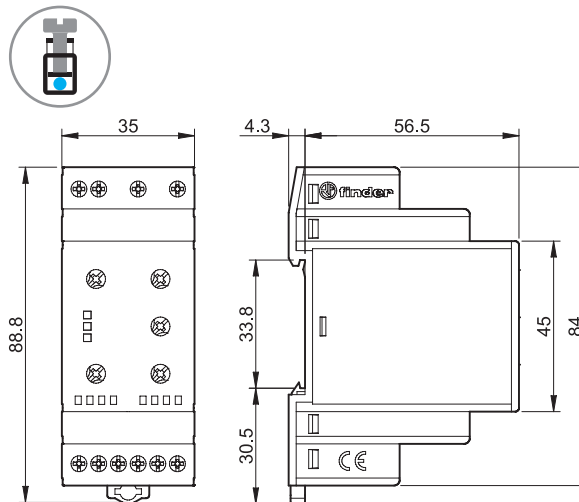

Type 70.61
Screw terminal

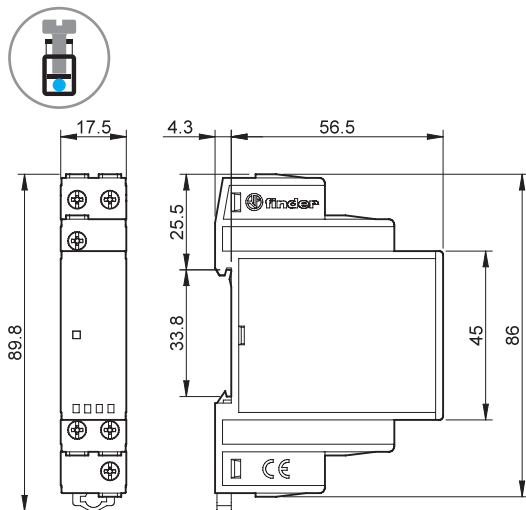

Type 70.62
Screw terminal

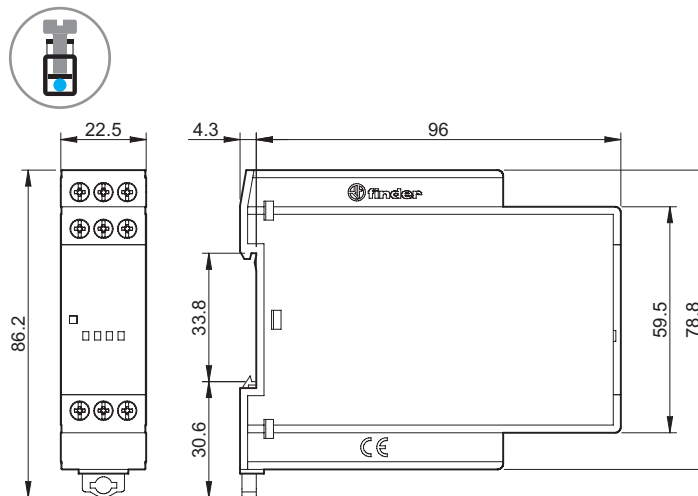

Accessories



020.01

Adaptor for panel mounting, plastic, 17.5 mm wide for 70.11 and 70.61

020.01

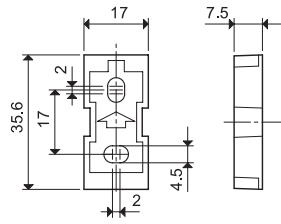

011.01

Adaptor for panel mounting, plastic, 35 mm wide for 70.31, 70.42 and 70.41

011.01

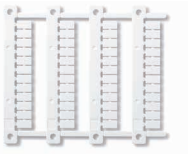
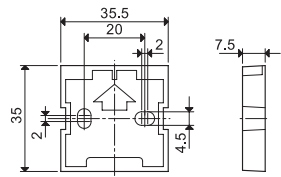

060.48

Sheet of marker tags (CEMBRE Thermal transfer printers) for relays types 70.11, 70.31, 70.41, 70.42 and 70.62 (48 tags), 6 x 12 mm

060.48



019.01

Identification tag, plastic, 1 tag, 17 x 25.5 mm for 70.11, 70.31, 70.42 and 70.41

019.01

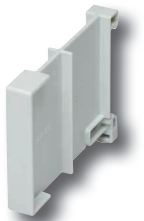

022.09

Separator for rail mounting, plastic, 9 mm wide

022.09

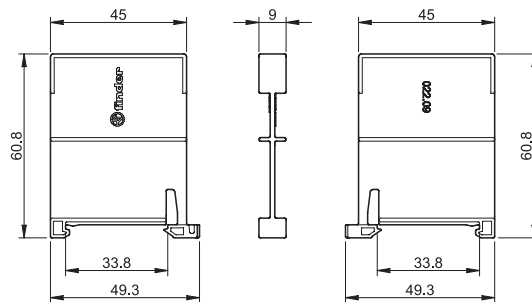

E

