



Keypad with LED display for DA1 and DC1 variable frequency drives



Part no. **DX-KEY-LED2**
 Catalog No. **186946**
 Eaton Catalog No. **DX-KEY-LED2**
 EL-Nummer **0004137449**
 (Norway)

Delivery program

Subrange			HMI device
Description			With 7-digital display assembly Front IP54 With approx. 3 m-long, plug-in connection cable (RJ45, 8-pin)
Length		m	3
For use with			DE1, DE11, DC1, DA1
Successor to 169132			

Design verification as per IEC/EN 61439

Technical data for design verification			
Operating ambient temperature min.		°C	-10
Operating ambient temperature max.		°C	50
IEC/EN 61439 design verification			
10.2 Strength of materials and parts			
10.2.2 Corrosion resistance			Meets the product standard's requirements.
10.2.3.1 Verification of thermal stability of enclosures			Meets the product standard's requirements.
10.2.3.2 Verification of resistance of insulating materials to normal heat			Meets the product standard's requirements.
10.2.3.3 Verification of resistance of insulating materials to abnormal heat and fire due to internal electric effects			Meets the product standard's requirements.
10.2.4 Resistance to ultra-violet (UV) radiation			Please enquire
10.2.5 Lifting			Does not apply, since the entire switchgear needs to be evaluated.
10.2.6 Mechanical impact			Does not apply, since the entire switchgear needs to be evaluated.
10.2.7 Inscriptions			Meets the product standard's requirements.
10.3 Degree of protection of ASSEMBLIES			Does not apply, since the entire switchgear needs to be evaluated.
10.4 Clearances and creepage distances			Meets the product standard's requirements.
10.5 Protection against electric shock			Does not apply, since the entire switchgear needs to be evaluated.
10.6 Incorporation of switching devices and components			Does not apply, since the entire switchgear needs to be evaluated.
10.7 Internal electrical circuits and connections			Is the panel builder's responsibility.
10.8 Connections for external conductors			Is the panel builder's responsibility.
10.9 Insulation properties			
10.9.2 Power-frequency electric strength			Is the panel builder's responsibility.
10.9.3 Impulse withstand voltage			Is the panel builder's responsibility.
10.9.4 Testing of enclosures made of insulating material			Is the panel builder's responsibility.
10.10 Temperature rise			The panel builder is responsible for the temperature rise calculation. Eaton will provide heat dissipation data for the devices.
10.11 Short-circuit rating			Is the panel builder's responsibility. The specifications for the switchgear must be observed.
10.12 Electromagnetic compatibility			Is the panel builder's responsibility. The specifications for the switchgear must be observed.
10.13 Mechanical function			The device meets the requirements, provided the information in the instruction leaflet (IL) is observed.

Technical data ETIM 7.0

Low-voltage industrial components (EG000017) / Accessories for frequency controller (EC002025)		
Electric engineering, automation, process control engineering / Electrical drive / Static frequency converter / Static frequency converter (accessory) (ecl@ss10.0.1-27-02-31-92 [AFR303003])		
Type of accessory		Control panel

Approvals

Product Standards		UL 508C; CSA-C22.2 No. 14; IEC/EN61800-3; IEC/EN61800-5; CE marking
-------------------	--	---

UL File No.	E172143
UL Category Control No.	NMMS, NMMS7
CSA File No.	UL report applies to both US and Canada
North America Certification	UL listed, certified by UL for use in Canada
Specially designed for North America	No
Suitable for	Branch circuits
Degree of Protection	IEC: IP00

Dimensions

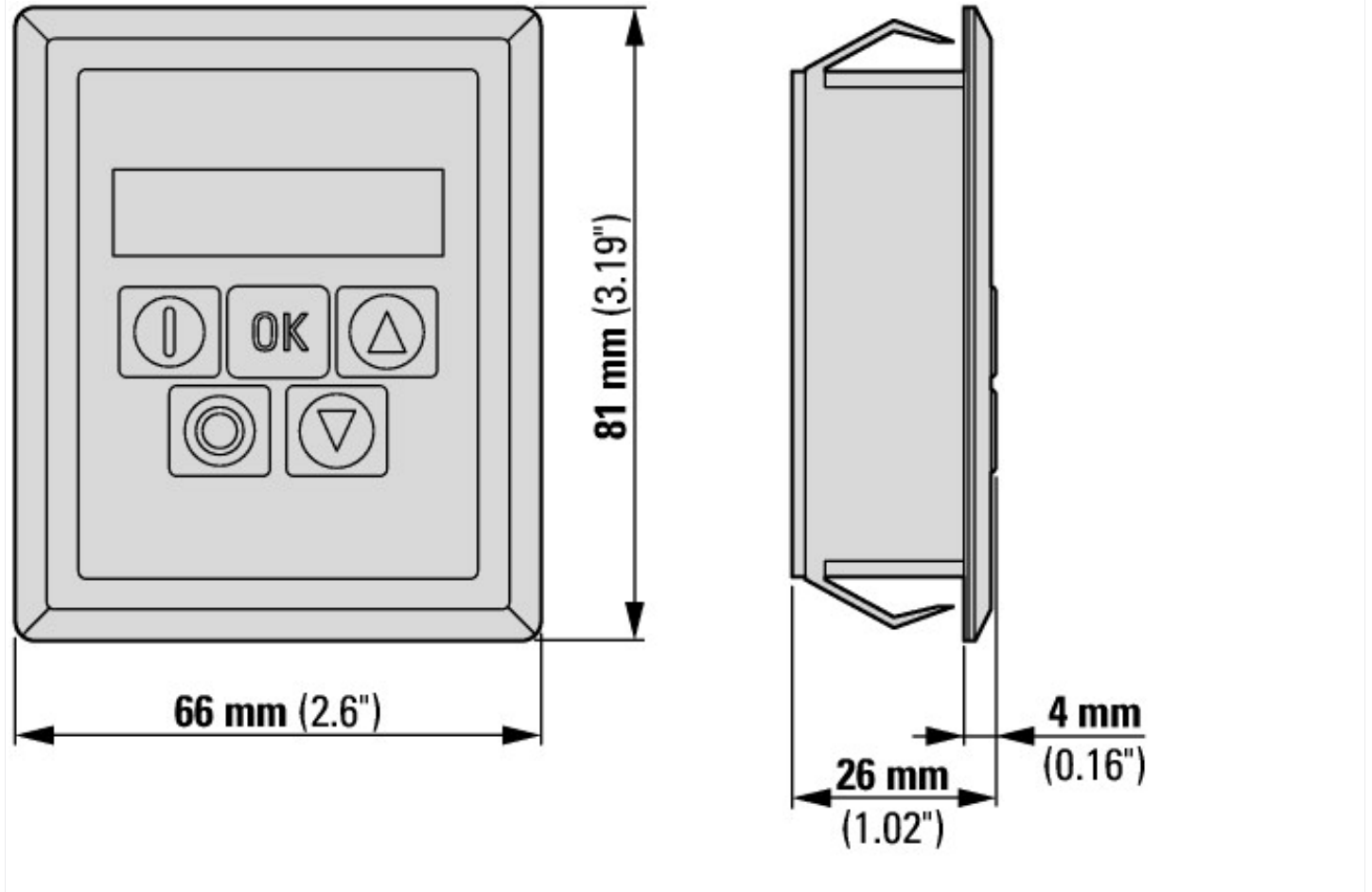

Additional product information (links)

IL04012020Z Remote Keypad LED/OLED	
IL04012020Z Remote Keypad LED/OLED	ftp://ftp.moeller.net/DOCUMENTATION/AWA_INSTRUCTIONS/IL04012020Z2018_05.pdf
MN04020003Z DC1 variable frequency drives, Installation manual	
MN04020003Z Frequenzumrichter DC1, Installationshandbuch - Deutsch	ftp://ftp.moeller.net/DOCUMENTATION/AWB_MANUALS/MN04020003Z_DE.pdf
MN04020003Z DC1 variable frequency drives, Installation manual - English	ftp://ftp.moeller.net/DOCUMENTATION/AWB_MANUALS/MN04020003Z_EN.pdf
MN04020003Z Frekvenční měnič DC1, manuál Instalace - čeština	ftp://ftp.moeller.net/DOCUMENTATION/AWB_MANUALS/MN04020003Z_CZ.pdf
MN04020003Z Convertitore di frequenza DC1, manuale Installazione - italiano	ftp://ftp.moeller.net/DOCUMENTATION/AWB_MANUALS/MN04020003Z_IT.pdf
MN04020005Z DA1 variable frequency drives, Installation manual	
MN04020005Z Frequenzumrichter DA1, Installationshandbuch - Deutsch	ftp://ftp.moeller.net/DOCUMENTATION/AWB_MANUALS/MN04020005Z_DE.pdf
MN04020005Z DA1 variable frequency drives, Installation manual - English	ftp://ftp.moeller.net/DOCUMENTATION/AWB_MANUALS/MN04020005Z_EN.pdf
MN04020005Z Convertitore di frequenza DA1, manuale Installazione - italiano	ftp://ftp.moeller.net/DOCUMENTATION/AWB_MANUALS/MN04020005Z_IT.pdf
CA04020001Z-EN Product Range Catalog: Efficient Engineering for Starting and Controlling Motors	http://www.eaton.eu/DE/ecm/groups/public/@pub/@europe/@electrical/documents/content/pct_1095238.pdf