

E10844

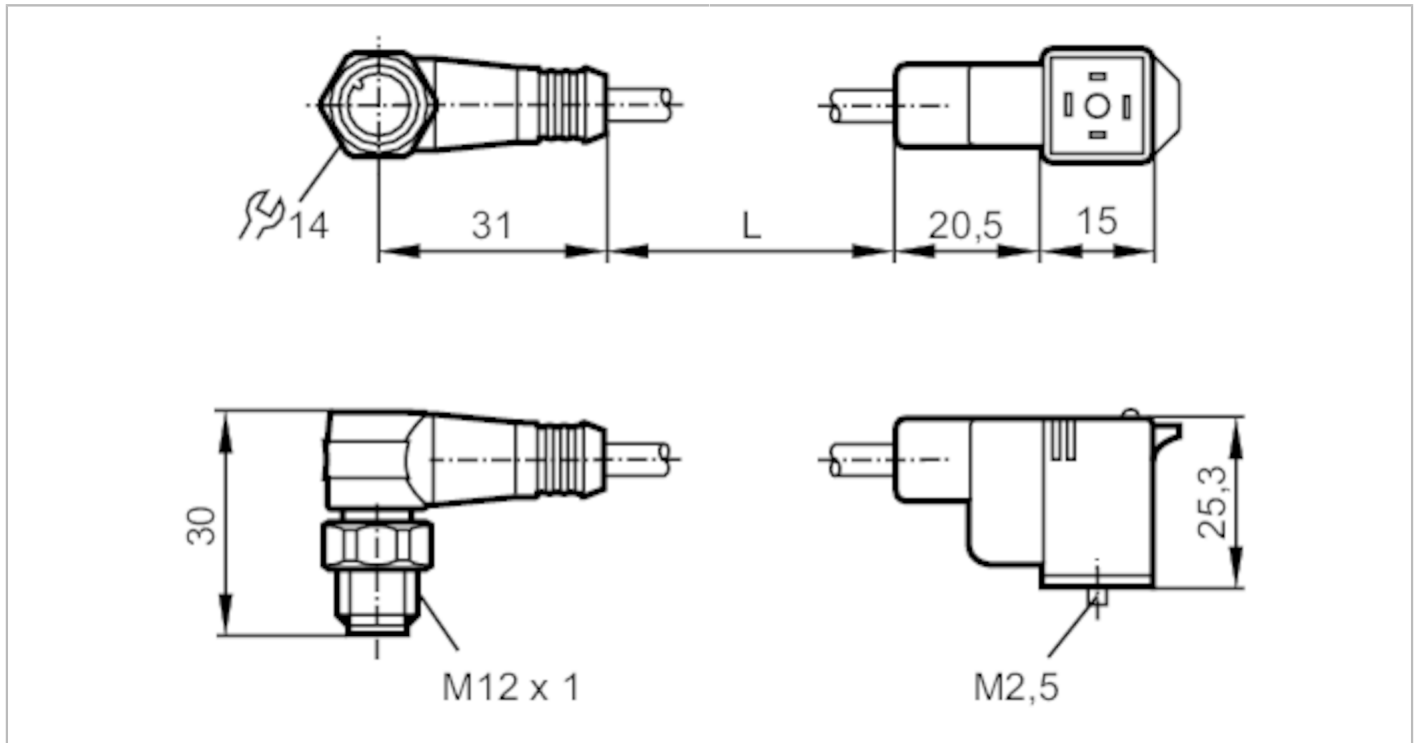

Jumper cable with valve plug

VVDAC041MSS00,3A03STAH030VAS



Application	
Special feature	Halogen-free
Electrical data	
Operating voltage [V]	< 24 AC/DC
Overvoltage protection	yes; (VDR)
Operating conditions	
Ambient temperature [°C]	-25...90
Protection	IP 67
Mechanical data	
Weight [g]	45.7
Materials	TPU
Material nut	stainless steel (1.4404 / 316L) / stainless steel (1.4404 / 316L)
Displays / operating elements	
Display	operation 1 x LED, yellow
Accessories	
Accessories (supplied)	screw panel for labelling
Remarks	
Pack quantity	1 pcs.
Electrical connection - plug	

Connector: 1 x M12, angled; Moulded body: TPU; Locking: stainless steel (1.4404 / 316L); Tightening torque: 0.5 Nm

E10844



Jumper cable with valve plug

VVDAC041MSS00,3A03STAH030VAS

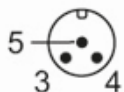

Electrical connection

Cable: 0.3 m, PUR, Halogen-free, black, Ø 4.8 mm; 3 x 0.5 mm² (16 x Ø 0.2 mm)

Connection

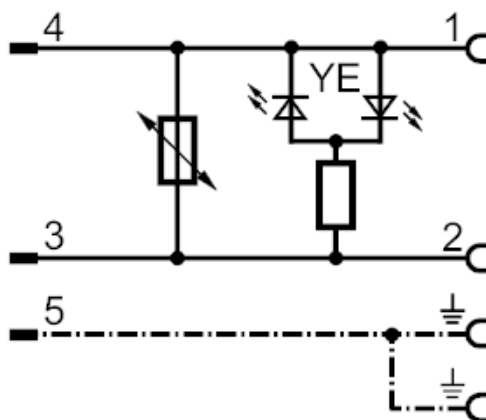

Electrical connection - socket

Connector: 1 x valve type C DIN, angled; Moulded body: TPU; Locking: stainless steel (1.4404 / 316L); Tightening torque: 0.5 Nm

