



**Part no.: 50137593**  
**AMS 307i 40**  
**Optical distance sensor**



CDRH



Figure can vary

## Contents

- Technical data
- Dimensioned drawings
- Electrical connection
- Operation and display
- Part number code
- Notes
- Accessories

Part no.: 50137593 – AMS 307i 40 – Optical distance sensor

## Technical data

| <b>Basic data</b>                |  |
|----------------------------------|--|
| Series                           | AMS 300i   |
| Application                      | Collision protection of cranes / gantry cranes<br>Positioning of electroplating plants<br>Positioning of high-bay storage devices<br>Positioning of skilnet systems and side-tracking skates |
| <b>Characteristic parameters</b> |  |
| MTTF                             | 31 years   |
| <b>Optical data</b>              |  |
| Light source                     | Laser , Red  |
| Laser class                      | 2 , IEC/EN 60825-1:2007  |
| <b>Measurement data</b>          |  |
| Measurement range                | 200 ... 40,000 mm  |
| Accuracy                         | 2 mm   |
| Reproducibility (3 sigma)        | 0.9 mm   |
| Max. traverse rate               | 10 m/s   |
| <b>Electrical data</b>           |  |
| <b>Performance data</b>          |  |
| Supply voltage $U_B$             | 18 ... 30 V , DC   |
| <b>Interface</b>                 |  |
| Type                             | SSI  |
| <b>SSI</b>                       |  |
| Clock frequency                  | 50 ... 800 kHz   |
| <b>Connection</b>                |  |
| Number of connections            | 3 Piece(s)   |
| <b>Connection 1</b>              |  |
| Type of connection               | Connector  |
| Designation on device            | PWR  |
| Function                         | Signal IN<br>Signal OUT<br>Voltage supply  |
| Thread size                      | M12  |
| Type                             | Male   |
| No. of pins                      | 5 -pin   |
| Encoding                         | A-coded  |
| <b>Connection 2</b>              |  |
| Type of connection               | Connector  |
| Designation on device            | SSI  |
| Function                         | Data interface   |
| Thread size                      | M12  |
| Type                             | Male   |
| No. of pins                      | 5 -pin   |
| Encoding                         | B-coded  |

## Part no.: 50137593 – AMS 307i 40 – Optical distance sensor

### Connection 3

|                       |                   |
|-----------------------|-------------------|
| Type of connection    | Connector         |
| Designation on device | SERVICE           |
| Function              | Service interface |
| Thread size           | M12               |
| Type                  | Female            |
| No. of pins           | 5 -pin            |
| Encoding              | A-coded           |

### Mechanical data

|                       |                           |
|-----------------------|---------------------------|
| Design                | Cubic                     |
| Dimension (W x H x L) | 84 mm x 166.5 mm x 159 mm |
| Housing material      | Metal                     |
| Net weight            | 2,450 g                   |
| Type of fastening     | Through-hole mounting     |

### Operation and display

|                      |                   |
|----------------------|-------------------|
| Type of display      | LC Display<br>LED |
| Operational controls | Membrane keyboard |

### Environmental data

|                                    |               |
|------------------------------------|---------------|
| Ambient temperature, operation     | -5 ... 50 °C  |
| Ambient temperature, storage       | -30 ... 70 °C |
| Relative humidity (non-condensing) | 90 %          |

### Certifications

|                      |         |
|----------------------|---------|
| Degree of protection | IP 65   |
| Protection class     | III     |
| Certifications       | c UL US |

### Classification

|                       |          |
|-----------------------|----------|
| Customs tariff number | 90318020 |
| eCl@ss 8.0            | 27270801 |
| eCl@ss 9.0            | 27270801 |
| ETIM 5.0              | EC001825 |
| ETIM 6.0              | EC001825 |

## Dimensioned drawings

All dimensions in millimeters

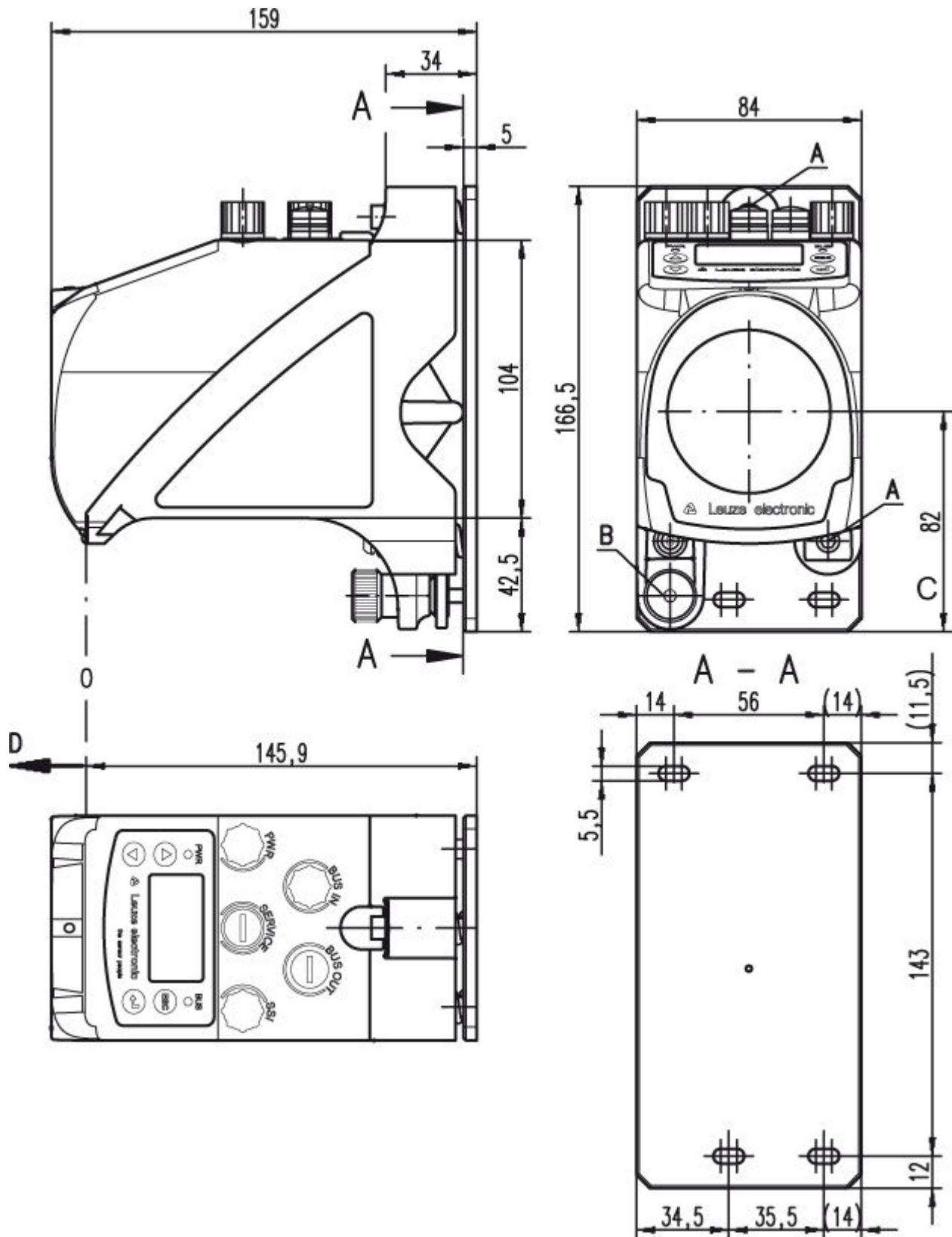

- A M 5 screw for alignment
- B Knurled nut with WAF 4 hexagon socket and M 5 nut for securing
- C Optical axis
- D Zero point of the distance to be measured

## Electrical connection

| Connection 1       | PWR                                       |
|--------------------|---|
| Type of connection | Connector                                 |
| Function           | Signal IN<br>Signal OUT<br>Voltage supply |
| Thread size        | M12                                       |
| Type               | Male                                      |
| Material           | Metal                                     |
| No. of pins        | 5 -pin                                    |
| Encoding           | A-coded                                   |

| Pin | Pin assignment |
|-----|----------------|
| 1   | V+             |
| 2   | I/O 1          |
| 3   | GND            |
| 4   | I/O 2          |
| 5   | FE             |

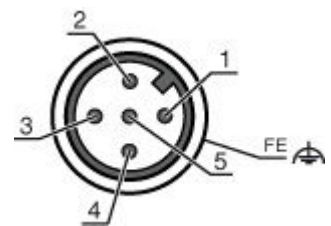

| Connection 2       | SSI            |
|--------------------|----------------|
| Type of connection | Connector      |
| Function           | Data interface |
| Thread size        | M12            |
| Type               | Male           |
| Material           | Metal          |
| No. of pins        | 5 -pin         |
| Encoding           | B-coded        |

| Pin | Pin assignment |
|-----|----------------|
| 1   | DATA+          |
| 2   | DATA-          |
| 3   | CLK+           |
| 4   | CLK-           |
| 5   | FE             |

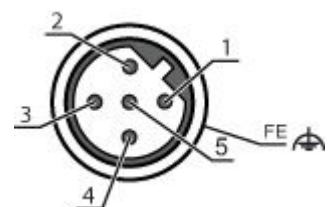

| Connection 3       | SERVICE           |
|--------------------|-------------------|
| Type of connection | Connector         |
| Function           | Service interface |
| Thread size        | M12               |
| Type               | Female            |
| Material           | Metal             |
| No. of pins        | 5 -pin            |
| Encoding           | A-coded           |

Part no.: 50137593 – AMS 307i 40 – Optical distance sensor

| Pin | Pin assignment |
|-----|----------------|
| 1   | n.c.           |
| 2   | RS 232-TX      |
| 3   | GND            |
| 4   | RS 232-RX      |
| 5   | n.c.           |

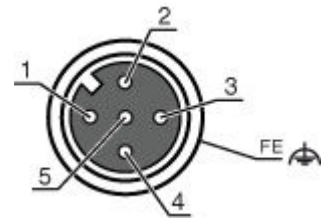

## Operation and display

### LEDs

| LED | Display | Meaning                  |  |
|-----|---------|--------------------------|--|
| 1   | PWR     | Off                      | No supply voltage  |
|     |         | Green, flashing          | Voltage connected / no measurement value output / initialization running |
|     |         | Green, continuous light  | Device OK, measurement value output                                      |
|     |         | Red, flashing            | Device OK, warning set   |
|     |         | Red, continuous light    | No measurement value output  |
|     |         | Orange, continuous light | No data transmission   |
| 2   | BUS     | Off                      | No supply voltage  |
|     |         | Green, continuous light  | Data transmission active   |
|     |         | Green, flashing          | Device ok, initialization phase  |

## Part number code

Part designation: **AMS 3XXi YYY Z AAA**

|      |   |
|------|---|
| AMS  | <b>Operating principle:</b><br>AMS: absolute measurement system   |
| 3XXi | <b>Series/interface (integrated fieldbus technology):</b><br>300i: RS 422/RS 232<br>301i: RS 485<br>304i: PROFIBUS DP / SSI<br>308i: TCP/IP<br>335i: CANopen<br>338i: EtherCAT<br>348i: PROFINET RT<br>355i: DeviceNet<br>358i: EtherNet/IP<br>384i: Interbus |
| YYY  | <b>Operating range:</b><br>40: max. operating range in m<br>120: max. operating range in m<br>200: max. operating range in m<br>300: max. operating range in m  |
| Z    | <b>Special equipment:</b><br>H: with heating  |
| AAA  | <b>Interface:</b><br>SSI: with SSI interface  |

### Note

A list with all available device types can be found on the Leuze electronic website at [www.leuze.com](http://www.leuze.com).

## Notes

### Observe intended use!

- This product is not a safety sensor and is not intended as personnel protection.
- The product may only be put into operation by competent persons.
- Only use the product in accordance with its intended use.

### WARNING! LASER RADIATION – LASER CLASS 2

#### Never look directly into the beam!

The device satisfies the requirements of IEC 60825-1:2007 (EN 60825-1:2007) safety regulations for a product of **laser class 2** as well as the U.S. 21 CFR 1040.10 regulations with deviations corresponding to "Laser Notice No. 50" from June 24, 2007.

- Never look directly into the laser beam or in the direction of reflected laser beams! If you look into the beam path over a longer time period, there is a risk of injury to the retina.
- Do not point the laser beam of the device at persons!
- Interrupt the laser beam using a non-transparent, non-reflective object if the laser beam is accidentally directed towards a person.
- When mounting and aligning the device, avoid reflections of the laser beam off reflective surfaces!
- CAUTION! Use of controls or adjustments or performance of procedures other than specified herein may result in hazardous light exposure.
- Observe the applicable statutory and local laser protection regulations.
- The device must not be tampered with and must not be changed in any way.  
There are no user-serviceable parts inside the device.  
Repairs must only be performed by Leuze electronic GmbH + Co. KG.

### NOTE

#### Affix laser information and warning signs!

Laser information and warning signs are affixed to the device. In addition, self-adhesive laser information and warning signs (stick-on labels) are supplied in several languages.



- Affix the laser information sheet to the device in the language appropriate for the place of use. When using the device in the US, use the stick-on label with the "Complies with 21 CFR 1040.10" note.
- Affix the laser information and warning signs near the device if no signs are attached to the device (e.g. because the device is too small) or if the attached laser information and warning signs are concealed due to the installation position.
- Affix the laser information and warning signs so that they are legible without exposing the reader to the laser radiation of the device or other optical radiation.

- For UL applications, use is only permitted in Class 2 circuits in accordance with the NEC (National Electric Code).
- Use as safety-related component within the safety function is possible, if the component combination is designed correspondingly by the machine manufacturer.



Part no.: 50137593 – AMS 307i 40 – Optical distance sensor

## Accessories



### Connection technology - Connection cables

|   | Part no. | Designation            | Article          | Description   |
|---|----------|------------------------|------------------|---|
|  | 50104171 | KB SSI/<br>IBS-5000-BA | Connection cable | Suitable for interface: SSI, Interbus-S<br>Connection 1: Connector, M12, Axial, Female, B-coded, 5 -pin<br>Connection 2: Open end<br>Shielded: Yes<br>Cable length: 5,000 mm<br>Sheathing material: PUR |
|  | 50132079 | KD U-M12-5A-<br>V1-050 | Connection cable | Connection 1: Connector, M12, Axial, Female, A-coded, 5 -pin<br>Connection 2: Open end<br>Shielded: No<br>Cable length: 5,000 mm<br>Sheathing material: PVC   |

### Reflective tapes for distance sensors

|   | Part no. | Designation                | Article         | Description   |
|---|----------|----------------------------|-----------------|---|
|   | 50115020 | Reflexfolie<br>200x200mm-H | Reflector       | Special design: Heating<br>Supply voltage: 230 V, AC<br>Design: Rectangular<br>Reflective surface: 200 mm x 200 mm<br>Base material: Aluminum composite<br>Fastening: Mounting plate, Through-hole mounting |
|  | 50104361 | Reflexfolie<br>200x200mm-S | Reflective tape | Design: Rectangular<br>Reflective surface: 200 mm x 200 mm<br>Chemical designation of the material: PMMA<br>Fastening: Adhesive   |

## Services

|   | Part no. | Designation | Article          | Description   |
|---|----------|-------------|------------------|---|
|  | S981001  | CS10-S-110  | Start-up support | Details: Performed at location of customer's choosing, duration: max. 10 hours.<br>Conditions: Devices and connection cables are already mounted, price not including travel costs and, if applicable, accommodation expenses.<br>Restrictions: No mechanical (mounting) and electrical (wiring) work performed, no changes (attachments, wiring, programming) to third-party components in the nearby environment. |
|  | S981005  | CS10-T-110  | Product training | Details: Location and content to be agreed upon, duration: max. 10 hours.<br>Conditions: Price not including travel costs and, if applicable, accommodation expenses.<br>Restrictions: Travel costs and accommodation expenses charged separately and according to expenditure.   |