

**Photoelectric sensor
Laser Distance Sensor (Triangulation)
Q4XTKLAF300-Q8**

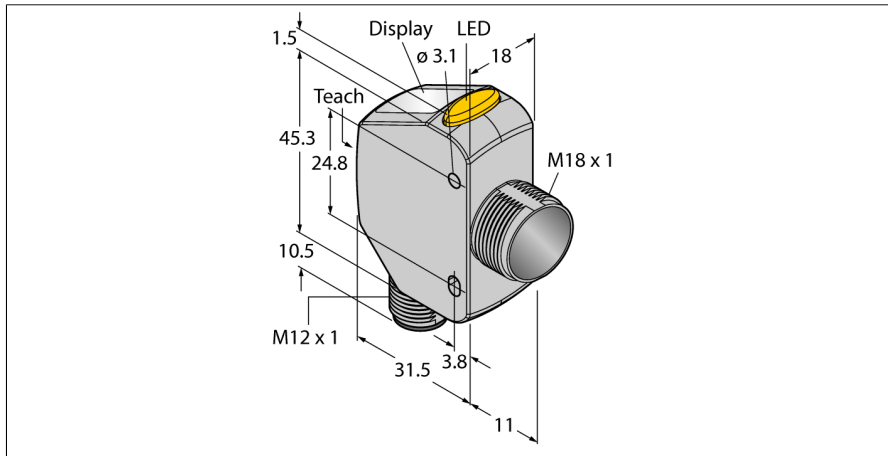

- Transmission of process value and parametrization via IO-link
- 4-digit 7-segment LED display
- 3 buttons
- Output indicator (yellow)
- IP67/69K
- ECOLAB-certified
- Range: 25...300 mm
- Laser class 1, red, 655 nm, acc. to IEC 60825-1:2007
- Operating voltage: 12...30 VDC
- 1 x PNP switching output with IO-Link communication
- 1 x PNP switching output or frequency output
- Rectangular model with offset M18 thread
- Stainless steel case (1.4404)

Wiring Diagram

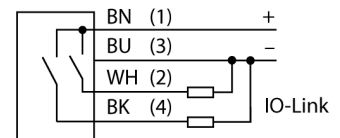

Functional principle

The Q4X is a laser-distance sensor working on the principle of laser triangulation. It has a reach of 300 mm and bipolar laser class 1 switching outputs (1 PNP and 1 NPN). With the dual mode functionality, the Q4X captures not only distances but also the light intensity that is reflected by an object. This unique feature allows lasers to be used for applications that would have been inconceivable before this.

In RUN mode, you can change the switch-point, adjust light and dark-switching and teach the sensor accordingly. In SETUP mode, you can select teach, all standard operating parameters and also return to the factory defaults.

Excess Gain Curve

Type designation	Q4XTKLAF300-Q8
Ident no.	3095301
Operating mode	Laser sensor, diffuse mode (triangulation)
Light type	red
Wavelength	655 nm
Laser class	▲ 1
Optical resolution	1 mm
Repeatability	0.5 mm
Range	25...300 mm
Ambient temperature	-10...+50 °C
Relative humidity min.	35 %
Relative humidity max.	95 %
Storage temperature	-25...+75 °C
Ambient light immunity	> 5000 lux
Operating voltage	10...30 VDC
DC rated operational current	≤ 28 mA
Short-circuit protection	yes
Reverse polarity protection	yes
Output function	NO/NC contact, PNP & IO-Link
Output 2	Switching output or frequency output
Readiness delay	≤ 750 ms
Response time typical	< 1.5 ms
Approvals	CE, cULus, ECOLAB
IO-Link Specification	V 1.1
IO-Link port type	class A
Communication Mode	COM 2 (38.4 kBaud)
Process data width	16 bit
Frame type	Type_2_2
Minimum cycle time	2 ms
Function Pin 4	IO-Link
Function Pin 2	DI
Maximum cable length	20 m
Profilunterstützung	Smart Sensor Profil
Design	Rectangular, Q4X
Dimensions	43.5 mm x 18 mm x 57.5 mm
Housing material	Stainless steel, V4A (1.4404)
Lens	acrylic, PMMA
Electrical connection	Connector, M12 - 1
Protection class	IP67/IP69K
Vibration resistance	MIL-STD-202G, Method 201A (10 to 60 Hz, 1.52 mm peak to peak amplitude, for 2 hours along the x, y and z-axis), sensor operating
Shock test	MIL-STD-202G, Method 213B Condition I (100G 6x along the XYZ-axis, 18 impacts), sensor in operation

Photoelectric sensor
Laser Distance Sensor (Triangulation)
Q4XTKLAF300-Q8

Switching state	LED yellow
Display	4-digit 7-segment LED display

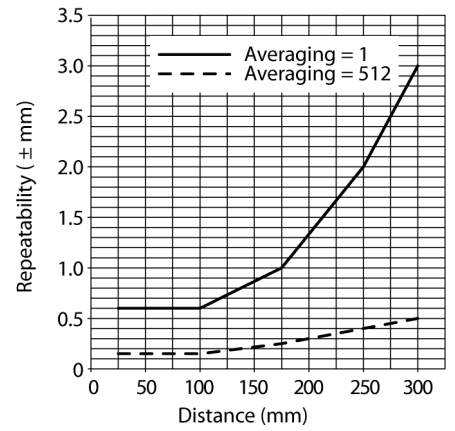

**Photoelectric sensor
Laser Distance Sensor (Triangulation)
Q4XTKLAF300-Q8**

Accessories

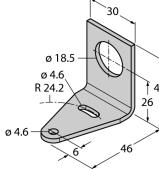
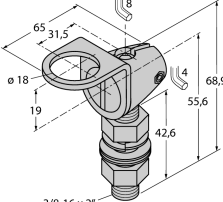
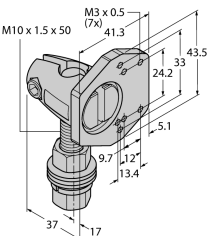
Type code	Ident no.	Description	
SMB18A	3033200	Mounting bracket, rectangular, stainless steel, for sensors with 18 mm thread	
SMB18FAM10	3011184	Mounting bracket, material VA 1.4401, for M10 x 1.5 thread, thread length 18 mm	
SMBQ4XFAM10	3091513	Mounting bracket, rotatable, stainless steel, for sensors of the Q4X/Q3X series, M10 x 1.5 thread	

Wiring accessories

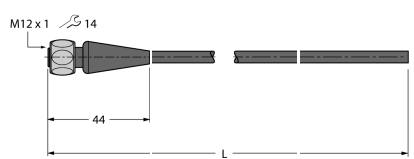
Type code	Ident no.	Description	
RKC4.5T-2/TEL	6625016	Connection cable, female M12, straight, 5-pin, cable length: 2 m, sheath material: PVC, black; cULus approval; other cable lengths and qualities available, see www.turck.com	
RKH4.5-2/TFG	6933455	Connection cable, M12 female connector, angled, 5-pin, cable length: 2 m, sheath material: TPE, gray; Ecolab approved, FDA and RoHS compliant; IP67, IP69K; Other cable lengths and designs are available, see www.turck.com	

**Photoelectric sensor
Laser Distance Sensor (Triangulation)
Q4XTKLAF300-Q8**

Wiring accessories

Type code	Ident no.	Description	
RKS4.5T-2/TEL	6626361	Connection cable, M12 female connector, straight, 5-pin, cable length: 2 m, sheath material: PVC, black; shielded; cULus approval; other cable lengths and qualities available, see www.turck.com	
WKS4.5T-2/TEL	6626364	Connection cable, M12 female connector, angled, 5-pin, cable length: 2 m, sheath material: PVC, black; shielded; cULus approval; other cable lengths and qualities available, see www.turck.com	

Function accessories

Type code	Ident no.	Description	
USB-2-IOL-0002	6825482	IO-Link Master with integrated USB port	
BL20-E-4IOL	6827385	IO-Link master module for the modular BL20 I/O system, 4-channel	
BL67-4IOL	6827386	4-channel IO-Link Master module for the modular BL67 I/O-system	

**Photoelectric sensor
Laser Distance Sensor (Triangulation)
Q4XTKLAF300-Q8**

Function accessories

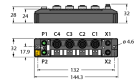
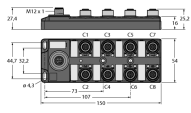
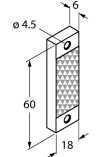
Type code	Ident no.	Description	
TBEN-S2-4IOL	6814024	Compact multiprotocol I/O module, 4 IO-Link Master 1.1 Class A, 4 universal PNP digital channels 0.5 A	
TBIL-M1-16DXP	6814102	16-channel I/O-hub for the connection of 16 digital PNP signals to an IO-Link master (input/output freely selectable per channel)	
BRT-Q4X-60X18	3095776	Reflector for Q4X laser sensors for clear object detection or dual-mode applications, rectangular housing: 60 mm x 18 mm	
BRT-Q4X-60X50	3095777	Reflector for Q4X laser sensors, for clear object detection or dual-mode applications, rectangular housing: 60 mm x 50 mm	