

# Reflex Sensor for Roller Conveyor Systems

## OPT1500

Part Number



- Energy savings thanks to EcoMode
- Optimized performance
- Quick wiring
- Scaled switching distance adjuster
- Time-saving installation with fast-clip mounting system

These sensors have been specially designed for use in accumulation roller conveyors. Their compact design allows for installation between rollers below the transport level. High-precision background suppression makes it possible to reliably detect even black objects at up to 900 mm. The scaled switching-distance adjuster assures quick and simple adjustment to the desired distance. Thanks to the innovative fast-clip mounting system and quick wiring, the sensor are installed and ready for use in no time flat.

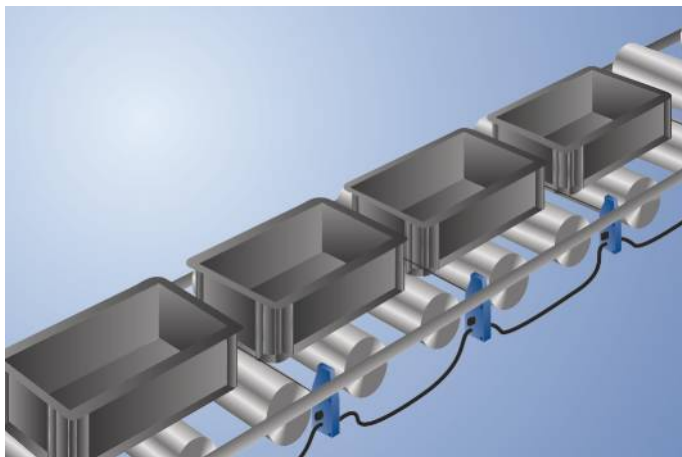

### Technical Data

Optical Data	
Range	900 mm
Switching Hysteresis	< 5 %
Light Source	Infrared Light
Wavelength	860 nm
Service Life (T = +25 °C)	100000 h
Risk Group (EN 62471)	1
Max. Ambient Light	90000 Lux
Opening Angle	3 °

Electrical Data	
Supply Voltage	20,6...30 V DC
Current Consumption Sensor (U <sub>b</sub> = 24 V)	< 16 mA
EcoMode	yes
Switching Frequency	100 Hz
Response Time	5 ms
Temperature Drift	< 5 %
Temperature Range	-40...60 °C
Number of Switching Outputs	1
Switching Output Voltage Drop	< 0,9 V
PNP Switching Output/Switching Current	200 mA
Short Circuit Protection	yes
Reverse Polarity Protection	yes
Overload Protection	yes
Logic	yes
Single Discharge	yes
Block Forwarding	yes
Solenoid Valve	yes
Protection Class	III

Mechanical Data	
Setting Method	Potentiometer
Housing Material	Plastic
Degree of Protection	IP65
Connection	M12 × 1; 4-pin
Cable Length	100 cm

Pneumatic Solenoid Valve Unit	
Valve no.	K04
Supply Voltage Valve	19,2...28,8 V
Current Consumption Valve	86 mA
Valve temperature range	-15...50 °C
Operating Pressure	4...7 bar
Nominal Width	0,8 mm
Nominal flow rate 1 -> 2	20 NL/min
Nominal flow rate 2 -> 3	100 NL/min
Supply-Line Connector Pipe	2 × 8 × 1
Working-Line Connector Pipe	4 × 1
Valve function	3/2-Way
Switching function	NC

PNP NC	●
Connection Diagram No.	734
Control Panel No.	OP1
Suitable Connection Equipment No.	2   2s
Suitable Mounting Technology No.	421

### Complementary Products

Adapter OPT70N, OPT70S, OPT70P  
ZPTX001 Quick Mount

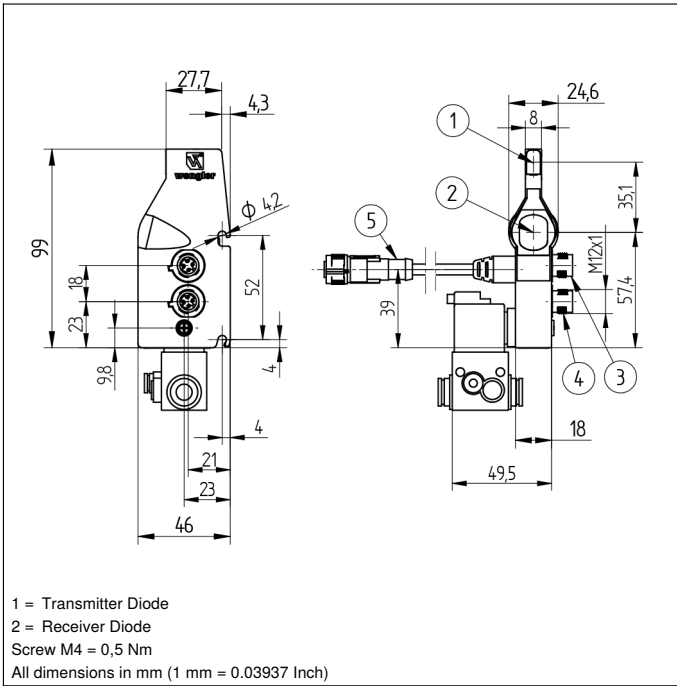

### Ctrl. Panel

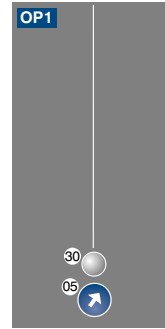

05 = Switching Distance Adjuster  
 30 = Switching Status/Contamination Warning

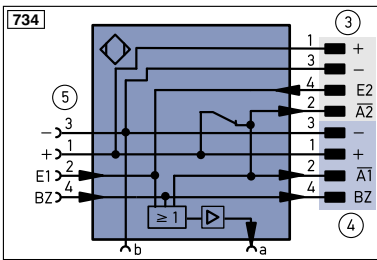

### Legend

+	Supply Voltage +	PT	Platinum measuring resistor	EN <sub>A</sub> RS422	Encoder A/Ā (TTL)
-	Supply Voltage 0 V	nc	not connected	EN <sub>B</sub> RS422	Encoder B/B̄ (TTL)
~	Supply Voltage (AC Voltage)	U	Test Input	EN <sub>A</sub>	Encoder A
A	Switching Output (NO)	Ū	Test Input inverted	EN <sub>B</sub>	Encoder B
Ā	Switching Output (NC)	W	Trigger Input	A <sub>MIN</sub>	Digital output MIN
V	Contamination/Error Output (NO)	W-	Ground for the Trigger Input	A <sub>MAX</sub>	Digital output MAX
Ṽ	Contamination/Error Output (NC)	O	Analog Output	A <sub>OK</sub>	Digital output OK
E	Input (analog or digital)	O-	Ground for the Analog Output	SY <sub>in</sub>	Synchronization In
T	Teach Input	BZ	Block Discharge	SY <sub>OUT</sub>	Synchronization OUT
Z	Time Delay (activation)	A <sub>WV</sub>	Valve Output	OL <sub>T</sub>	Brightness output
S	Shielding	a	Valve Control Output +	M	Maintenance
RxD	Interface Receive Path	b	Valve Control Output 0 V	rsv	reserved
TxD	Interface Send Path	SY	Synchronization	Wire Colors according to DIN IEC 757	
RDY	Ready	SY-	Ground for the Synchronization	BK	Black
GND	Ground	E+	Receiver-Line	BN	Brown
CL	Clock	S+	Emitter-Line	RD	Red
E/A	Output/Input programmable	±	Grounding	OG	Orange
	IO-Link	S <sub>n</sub> R	Switching Distance Reduction	YE	Yellow
PoE	Power over Ethernet	Rx+/-	Ethernet Receive Path	GN	Green
IN	Safety Input	Tx+/-	Ethernet Send Path	BU	Blue
OSSD	Safety Output	Bus	Interfaces-Bus A(+)/B(-)	VT	Violet
Signal	Signal Output	L <sub>a</sub>	Emitted Light disengageable	GY	Grey
Bl_D+/-	Ethernet Gigabit bidirect. data line (A-D)	Mag	Magnet activation	WH	White
EN <sub>0</sub> RS422	Encoder 0-pulse 0-0̄ (TTL)	RES	Input confirmation	PK	Pink
		EDM	Contactor Monitoring	GNVE	Green/Yellow

### Switching Distance Deviation

Typical characteristic curve based on white, 90 % remission

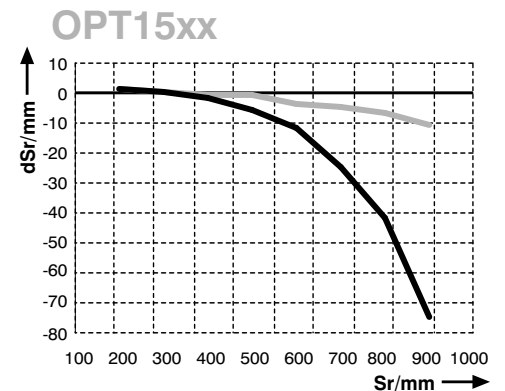

Sr = Switching Distance

dSr = Switching Distance Change

— black 6 % remission

— grey 18 % remission

