

INDUSTRIAL SPECIALTY LIGHTING

Industrial medical - Datasheet

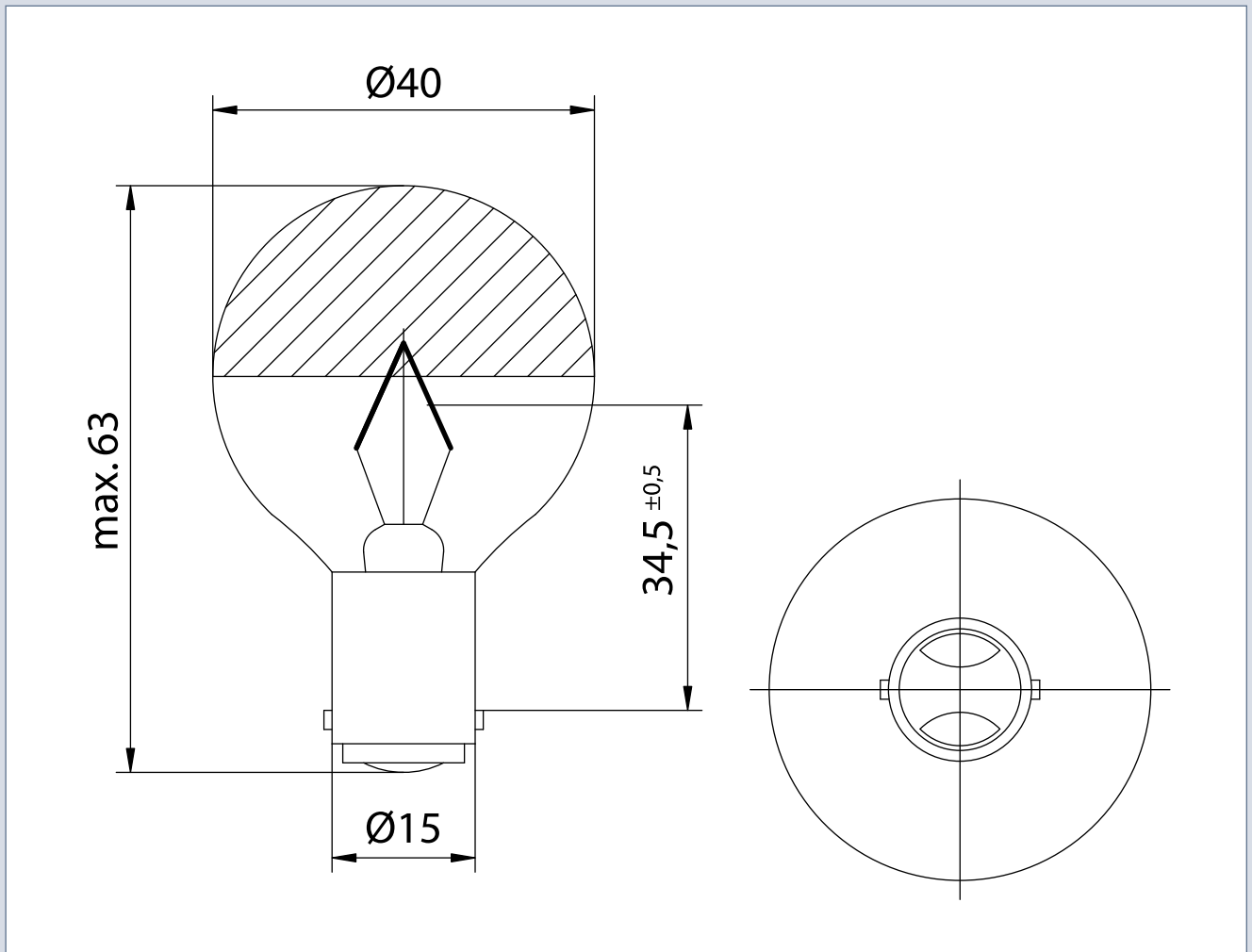

MEDICAL LAMPS - 110V 30W BA15D

PRODUCT NUMBER **302936030** []

Tol.

VOLTAGE	110	V	
WATTAGE	30	W	± 8
LUMEN OUTPUT	280	LM	± 10
LUMEN PRO WATT	9.3	LM/W	
AVERAGE LIFE	600	H	
BASE	BA15D	/	
REMARKS	H016170		
BRAND	DR. FISCHER		

FOR INFORMATIONAL PURPOSES ONLY. SIL INT. BV. DISCLAIMS ALL WARRANTIES WITHOUT LIMITATION. INFORMATION MIGHT BE SUBJECT TO CHANGE.



MEDICAL



ENTERTAINMENT



TRAFFIC



MARINE



RAILWAY



AIRFIELD



VARIOUS



TAILOR MADE



IR / UV



PROJECTION



Special industrial Lighting
Ruysdaelbaan 3F
5642 JJ Eindhoven
The Netherlands

Tel : + 31 40 2868 913
Fax : + 31 40 2868 207
Website: www.sillamps.com
Email : silint@special.nl