

TECHNICAL CHARACTERISTICS

MATERIAL
 INSULATOR: PA 66
 FLAMMABILITY RATING: UL94-V0
 COLOR: GREEN
 CONTACT PIN: BRASS (CuZn)
 SURFACE OF SOLDER TAIL PLATING: TIN

ENVIRONMENTAL
 OPERATING TEMPERATURE: -40 UP TO 105°C
 COMPLIANCE: LEAD FREE AND ROHS

ELECTRICAL
 CURRENT RATING: 10A
 WORKING VOLTAGE: 300VAC
 WITHSTANDING VOLTAGE: 1.6KV
 CONTACT RESISTANCE: 20 mOhm MAX

STANDARD
 CERTIFIED E315414

MECHANICAL
 PITCH: 5.08mm

SOLDERING
 JEDEC LEAD FREE WAVE SOLDERING PROCESS

PACKAGING
 BOX

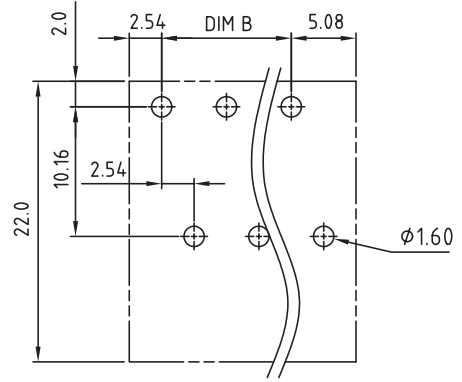

PCB LAYOUT - COMPONENT VIEW

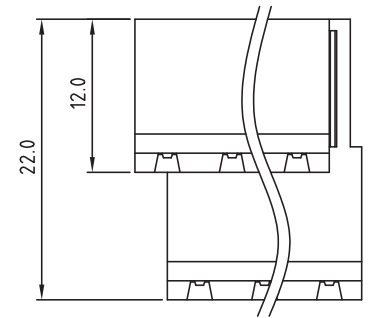
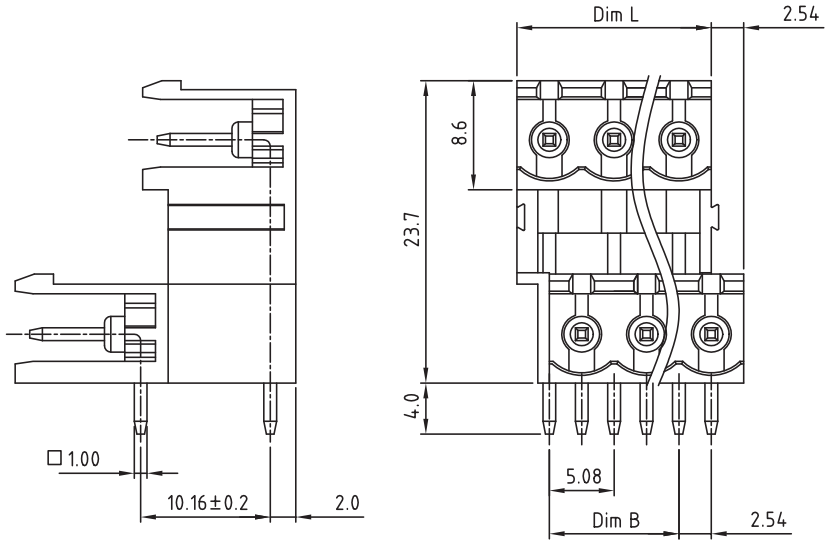

Poles	04	06	08	10	12	14	16	18	20	22	24	26
Dim L	10.16	15.24	20.32	25.40	30.48	35.56	40.64	45.72	50.80	55.88	60.96	66.04
Dim B	5.08	10.16	15.24	20.32	25.40	30.48	35.56	40.64	45.72	50.80	55.88	60.96
TOL	±0.15			±0.20				±0.25				
Poles	28	30	32	34	36	38	40	42	44	46	48	
Dim L	71.12	76.20	81.28	86.36	91.44	96.52	101.60	106.68	111.76	116.84	121.92	
Dim B	66.04	71.12	76.20	81.28	86.36	91.44	96.52	101.60	106.68	111.76	116.84	
TOL	±0.25		±0.30					±0.35				

RoHS Compliant			
G			
F			
E			
D			
C			
B	07-JUL-15	UPDATE	AK
A	18-JUN-10	PDF	JP
REV	DATE	FILE	BY

PROJECTION:		
		
APPROVAL: FBr		

GENERAL TOLERANCE	
.X = +/- 0.2	
.XX = +/- 0.15	

UNIT: MM
SCALE:
SHEET: 1/2
DRAW: MARVIN



WÜRTH ELEKTRONIK

DESCRIPTION: SERIE 3355 - 5.08MM DOUBLE LEVEL HORIZONTAL MALE PCB HEADER TYPE WR-TBL	
WERI PART NO: 691 335 510 0xx	

SIZE
A4

1

2

3

4

5

Cautions and Warnings:

This electronic component is designed and developed with the intention for use in general electronics equipments.

Before incorporating the components into any equipments in the field such as aerospace, aviation, nuclear control, submarine, transportation, (automotive control, train control, ship control), transportation signal, disaster prevention, medical, public information network etc. where higher safety and reliability are especially required or if there is possibility of direct damage or injury to human body, Würth Elektronik must be asked for a written approval.



In addition, even electronic component in general electronic equipments, when used in electrical circuits that require high safety, reliability functions or performance, the sufficient reliability evaluation-check for the safety must be performed before by the user before usage.

A

B

C

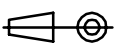
RoHS Compliant

G				PROJECTION: 	GENERAL TOLERANCE .X = +/- 0.2 .XX = +/- 0.15		
F							
E							
D							
C				APPROVAL: JC	UNIT: MM	DESCRIPTION: DISCLAIMER	SIZE A4
B					SCALE:		
A	10-SEP-14	PDF	QL		SHEET: 2/2	WERI PART NO: DISCLAIMER	
REV	DATE	FILE	BY		DRAW: QL		

D