



TAOGLAS®



Datasheet

25*25*4.5mm Wi-Fi/Bluetooth Patch

Part No:
WLP.2450.25.4.A.02

Description:
25*25*4.5mm Wi-Fi/Bluetooth 2450MHz Patch

Features:

- 4.5dBi Peak gain
- Low Axial Ratio
- Pin Type with adhesive for ease of mounting
- Automotive TS16949 Production and Quality Approved
- Dimensions: 25*25*4.5mm
- RoHS & Reach Compliant

1. Introduction	3
2. Specifications	4
3. Antenna Characteristics	5
4. Radiation Patterns	8
5. Mechanical Drawing	10
6. EVB Mechanical Drawing	11
7. Footprint	12
8. Packaging	13
<hr/>	
Changelog	14

Taoglas makes no warranties based on the accuracy or completeness of the contents of this document and reserves the right to make changes to specifications and product descriptions at any time without notice. Taoglas reserves all rights to this document and the information contained herein. Reproduction, use or disclosure to third parties without express permission is strictly prohibited.



1. Introduction



This WLP.25 patch antenna for ISM, Wi-Fi, Bluetooth and Zigbee is based on smart XtremeGain™ technology. It is mounted via pin and double-sided adhesive and has been selected as optimal solution for the 50*50mm ground plane. This passive patch offers typical gain response from 2.5 dBi and a higher gain can be achieved, depending on the Ground Plane, the space available and clearance afforded. The WLP.25's high gain performance is a perfect solution for metering and remote monitoring applications; it can deliver longer range than smaller chip antennas.

Many module manufacturers specify peak gain limits for any antennas that are to be connected to that module. Those peak gain limits are based on free-space conditions. In practice, the peak gain of an antenna tested in free-space can degrade by at least 1 or 2dBi when put inside a device. So ideally you should go for a slightly higher peak gain antenna than mentioned on the module specification to compensate for this effect, giving you better performance.

Upon testing of any of our antennas with your device and a selection of appropriate layout, integration technique, or cable, Taoglas can make sure any of our antennas' peak gain will be below the peak gain limits. Taoglas can then issue a specification and/or report for the selected antenna in your device that will clearly show it complying with the peak gain limits, so you can be assured you are meeting regulatory requirements for that module.

For example, a module manufacturer may state that the antenna must have less than 2dBi peak gain, but you don't need to select an embedded antenna that has a peak gain of less than 2dBi in free-space. This will give you a less optimized solution. It is better to go for a slightly higher free-space peak gain of 3dBi or more if available. Once that antenna gets integrated into your device, performance will degrade below this 2dBi peak gain due to the effects of GND plane, surrounding components, and device housing. If you want to be absolutely sure, contact Taoglas and we will test. Choosing a Taoglas antenna with a higher peak gain than what is specified by the module manufacturer and enlisting our help will ensure you are getting the best performance possible without exceeding the peak gain limits.

This antenna can be tuned for a custom device environment, subject to NRE and MOQ. For further information please contact your regional Taoglas customer support team.

2. Specifications

Wi-Fi Electrical	
Frequency (MHz)	2400~2500
Efficiency (%)	76.2
Axial Ratio (dB)	< 2
Peak Gain (dBi)	4.5
Average Gain (dB)	-1.2
Impedance	50 Ω
Polarization	Broadly Circularly Polarized
Mechanical	
Dimensions	25*25*4.5 mm
Pin Length	2.27 mm
Material	Ceramic
Ground Plane size	50*50 mm
Environmental	
Temperature Range	-40°C to +105°C
Humidity	Non-condensing 65°C 95% RH

3. Antenna Characteristics

3.1 Return Loss

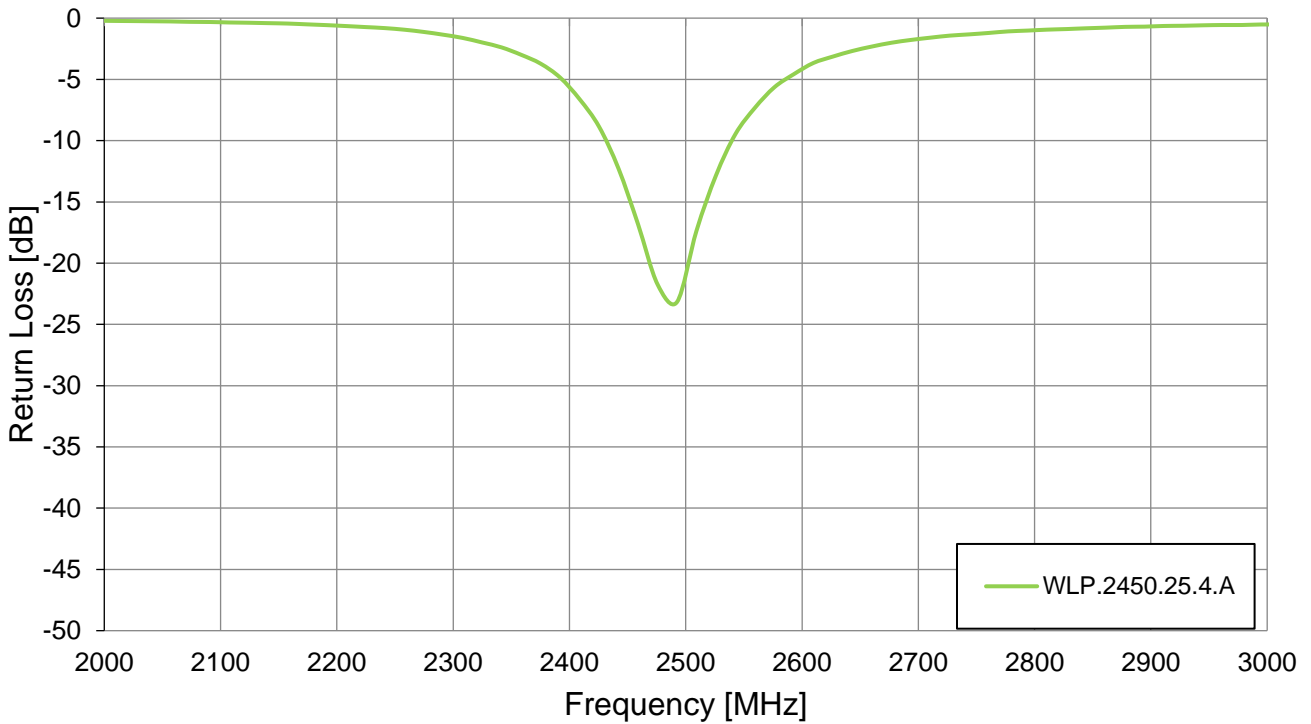

3.2 VSWR

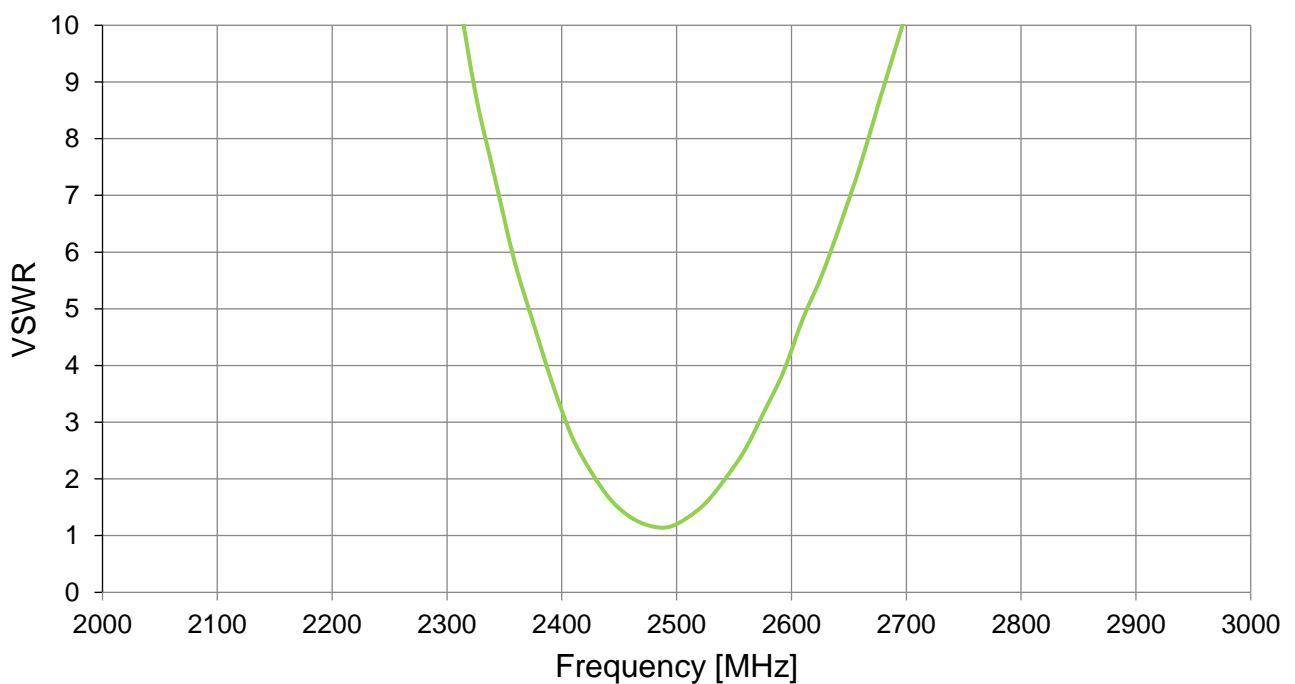

3.3 Efficiency

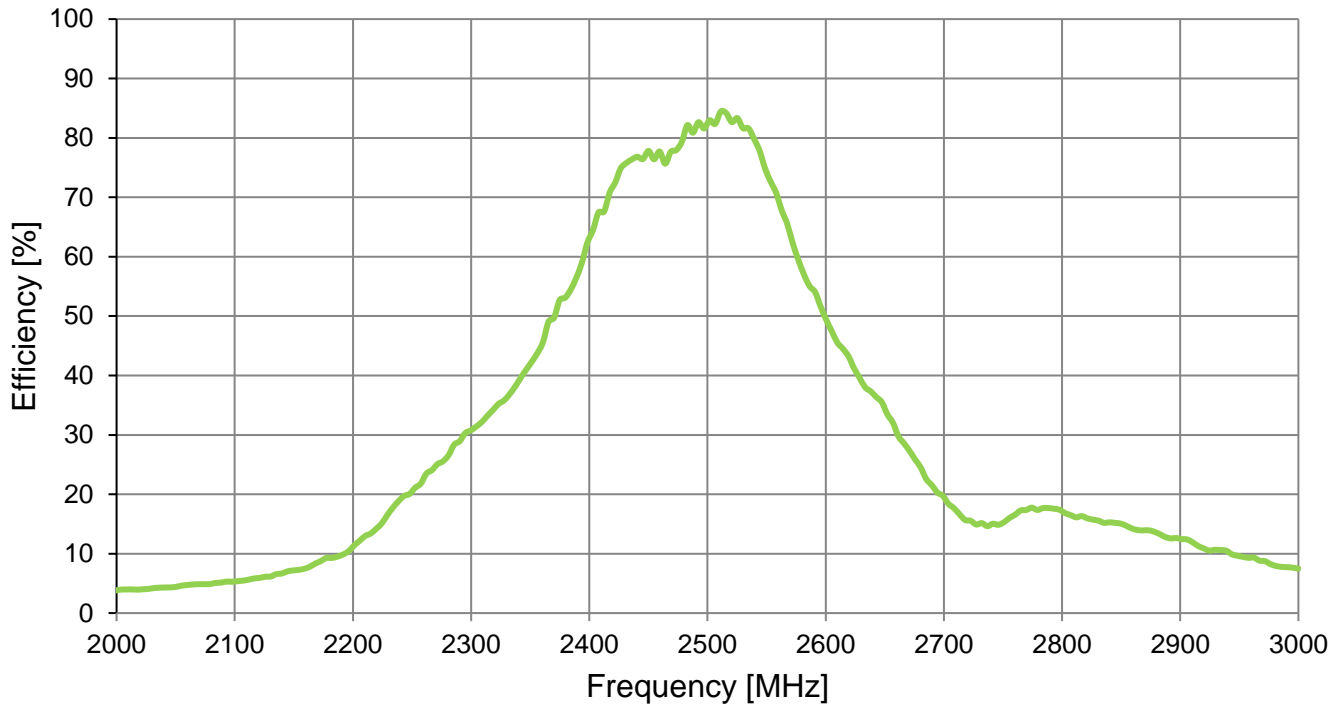

3.4 Peak Gain

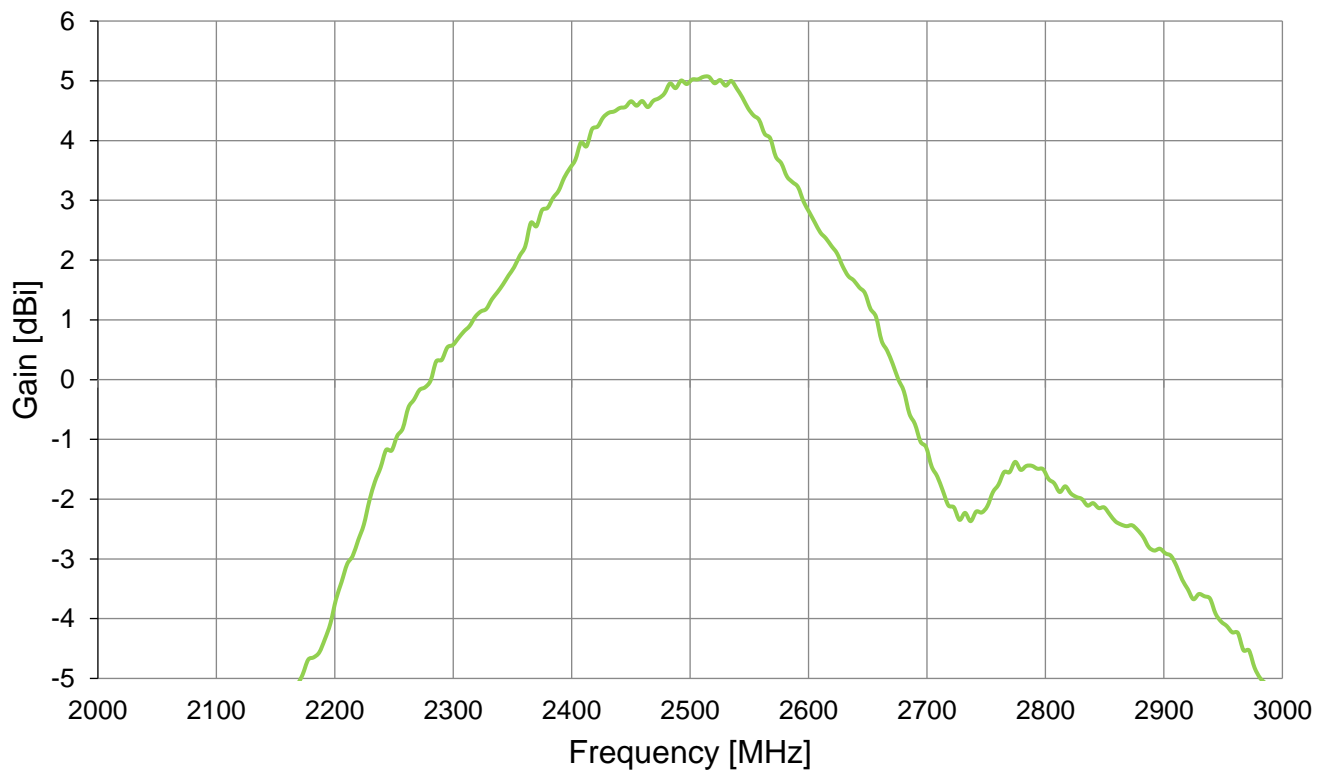

3.5 Average Gain

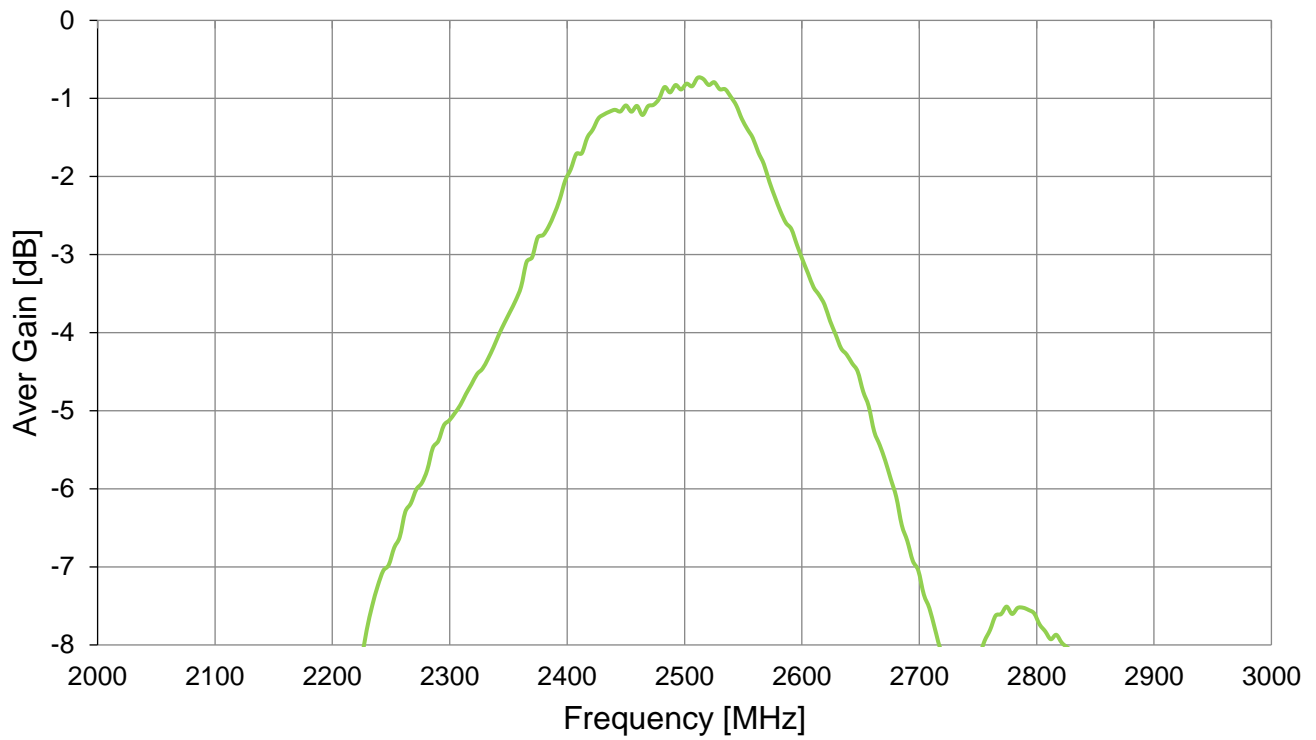

3.6 Axial Ratio

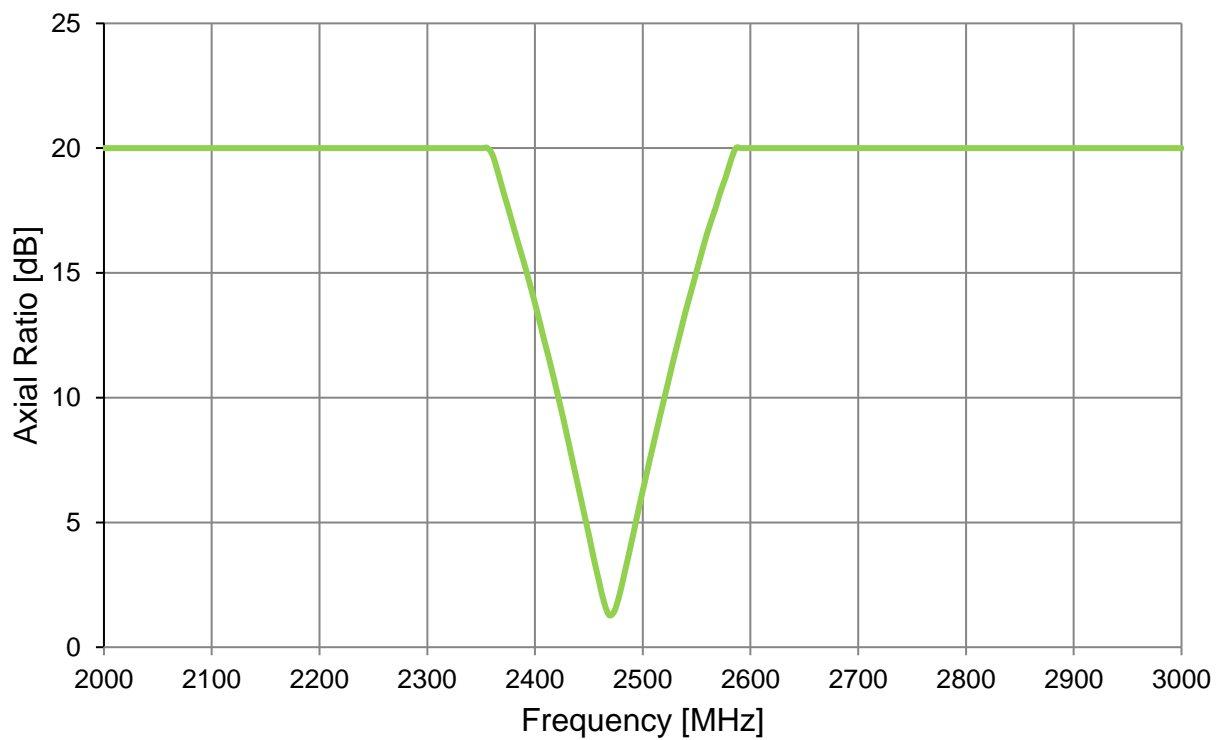

4. Radiation Patterns

4.1 2D Radiation Patterns

XY Plane

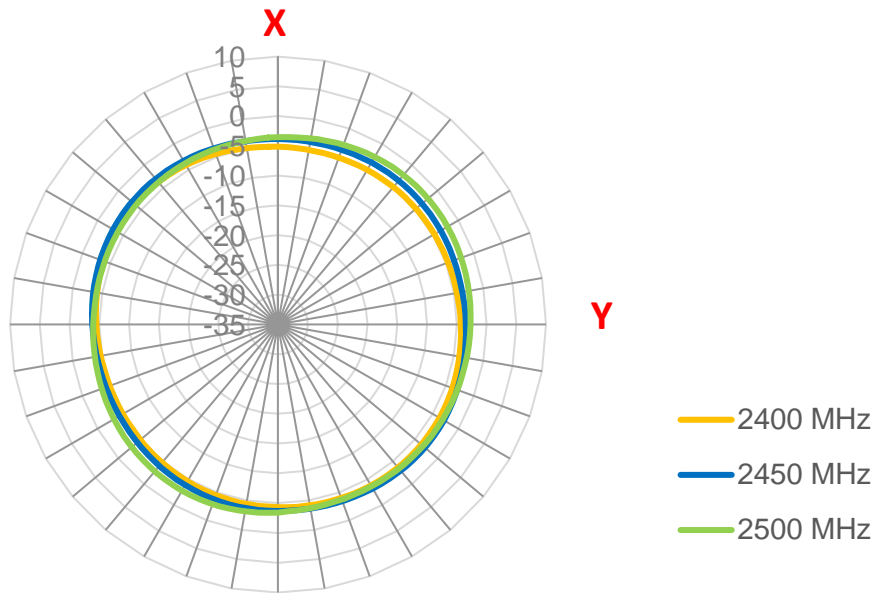

XZ Plane

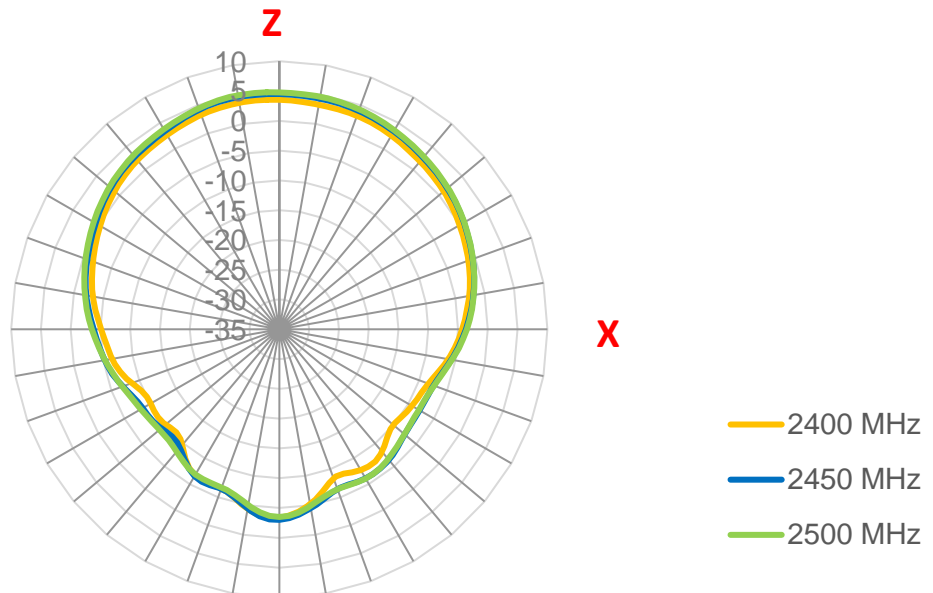

XZ Plane

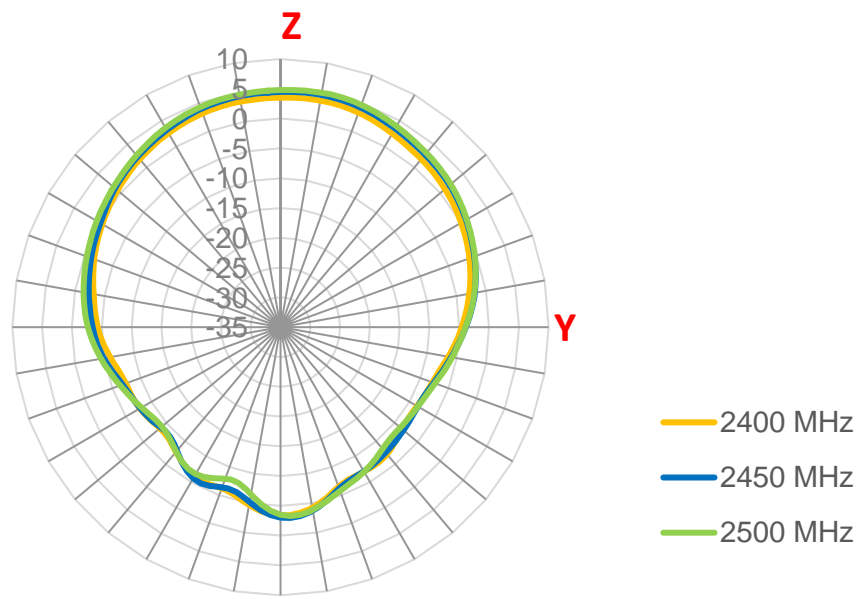

5. Mechanical Drawing (Units: mm)

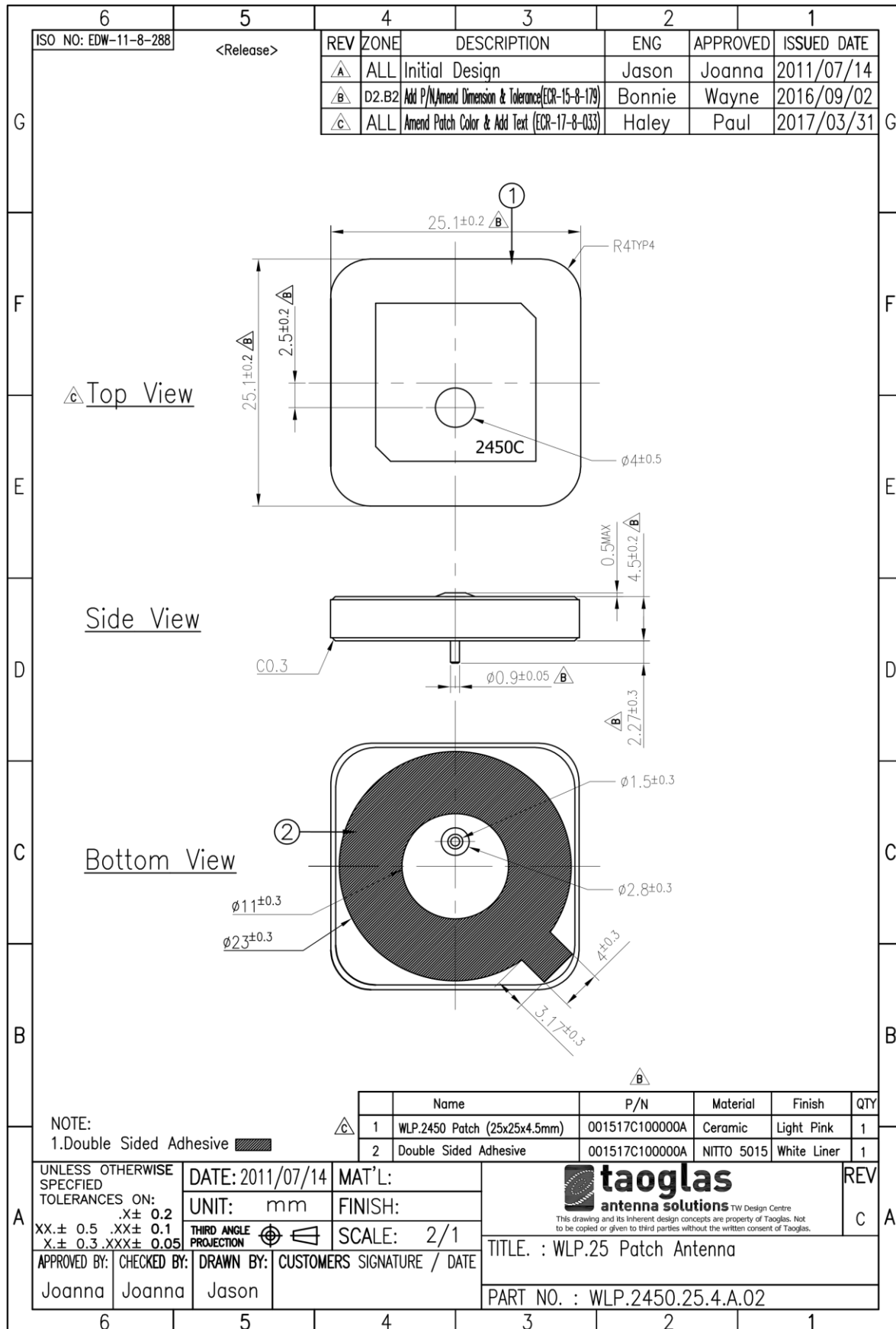

6. Evaluation Board Mechanical Drawing (Units:

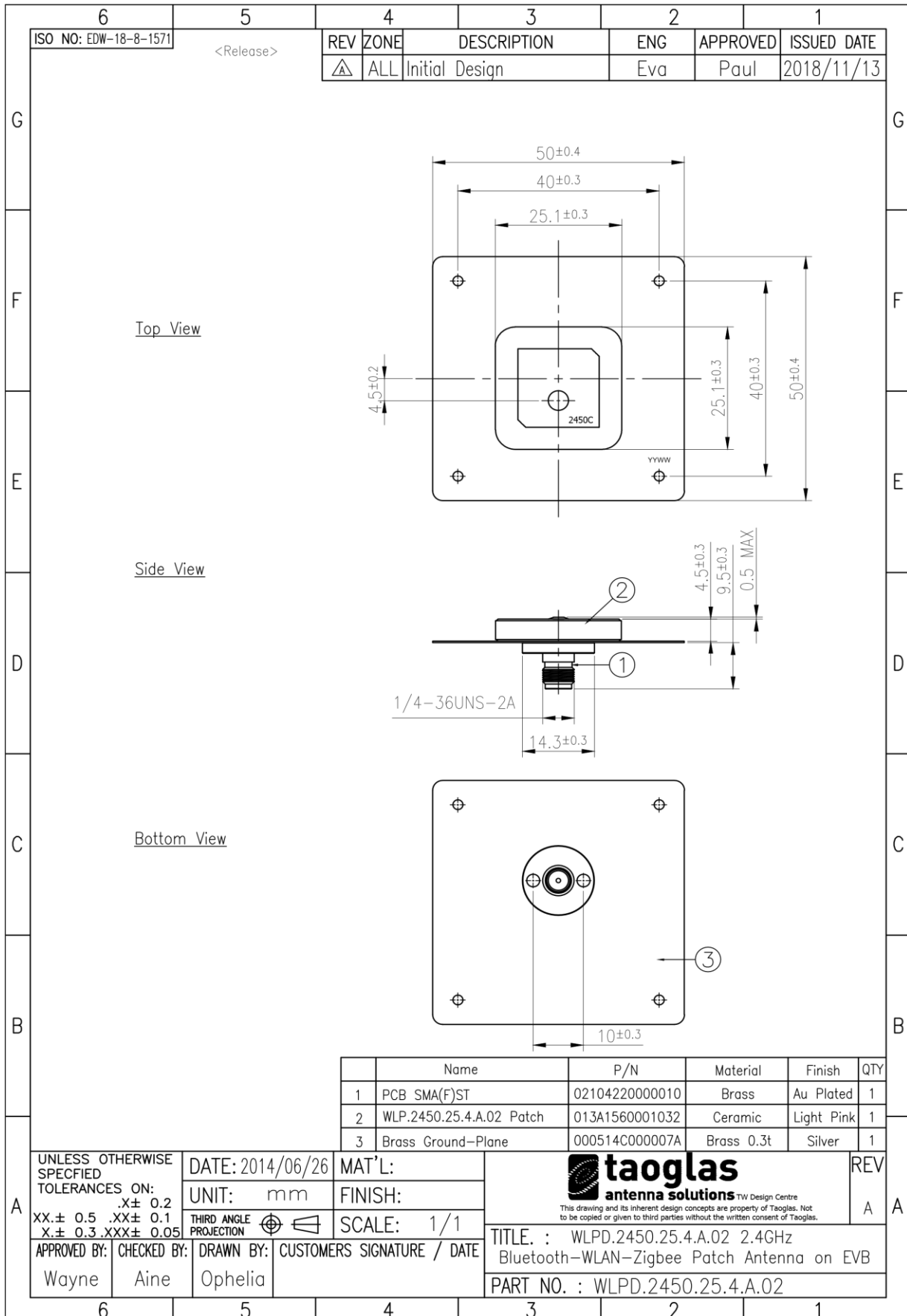

7. Footprint

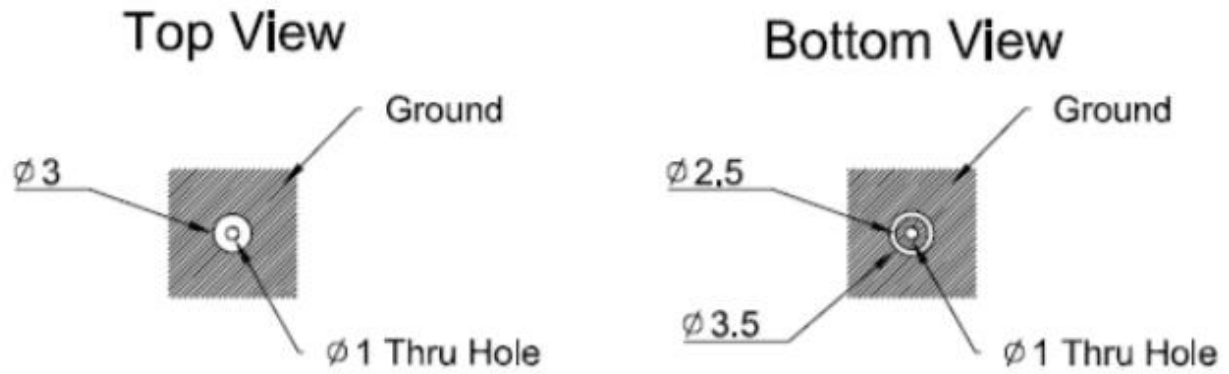

Tolerance: +/- 0,20
Unit:mm

8. Packaging

WLP.2450.25.4.A.02 Packaging Specifications

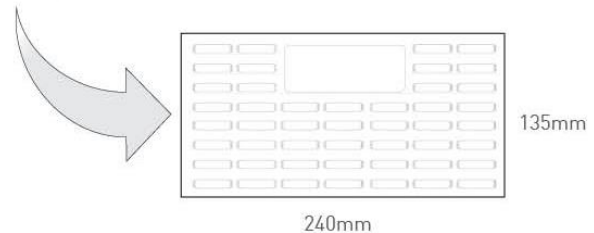

50 pcs WLP.2450.25.4.A.02 per tray
Tray Dimensions - 240*135mm
Total Weight - 625g

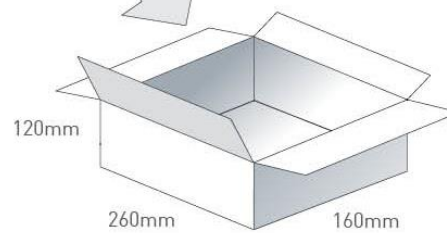

4 trays / 200 pcs per box
Box Dimensions - 260*160*120
Weight - 2.5Kg

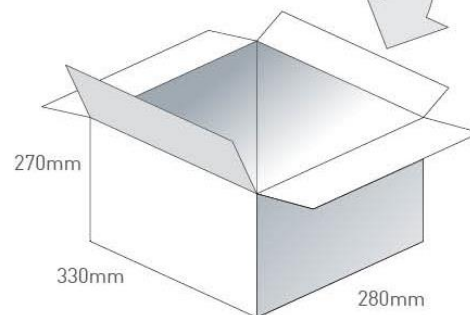

4 boxes / 800 pcs per carton
Carton Dimensions - 330*280*270
Weight - 10Kg

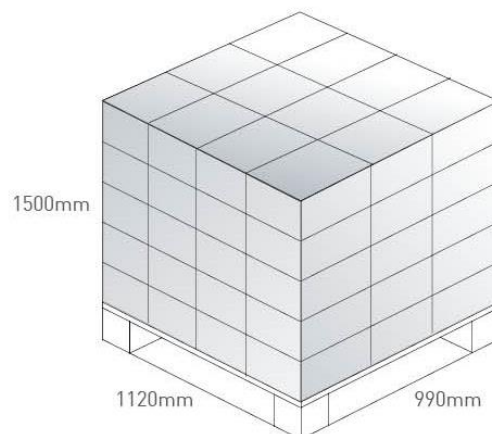

Pallet Dimensions 1120mm*990mm*1500mm
60 Cartons per pallet
12 Cartons per layer
5 Layers

Changelog for the datasheet

SPE-11-8-033 – WLP.2450.25.4.A.02

Revision: I (Current Version)

Date:	2020-03-27
Changes:	Updated Template and polarization
Changes Made by:	Jack Conroy

Previous Revisions

Revision: H

Date:	2017-03-23
Changes:	Drawing updated
Changes Made by:	Andy Mahoney

Revision: C

Date:	2012-02-04
Changes:	Packaging Details Updated
Changes Made by:	Technical Writer

Revision: G

Date:	2016-08-16
Changes:	Amended Pin Length
Changes Made by:	Andy Mahoney

Revision: B

Date:	2011-07-11
Changes:	Updated Data
Changes Made by:	Technical Writer

Revision: F

Date:	2015-12-08
Changes:	Amended Polarization
Changes Made by:	Aine Doyle

Revision: A (Original First Release)

Date:	2007-03-01
Notes:	
Author:	Technical Writer

Revision: E

Date:	2015-03-04
Changes:	Added Note on Gain
Changes Made by:	Aine Doyle

Revision: D

Date:	2013-04-24
Changes:	Packaging Details Updated
Changes Made by:	Technical Writer



TAOGLAS®

www.taoglas.com

