



Model Number

V1-W-BK5M-PUR-U-V1-G

Connection cable, M12 to M12, PUR cable, 4-pin

Features

- UL Recognized Component
- Knurled nut suitable for tool assembly
- Immunity to vibration, with mechanical latching
- Degree of protection IP67 / IP68 / IP69K
- Flame resistant cable
- Halogen-free
- Gold plated contacts
- Suitable for drag chains

Dimensions

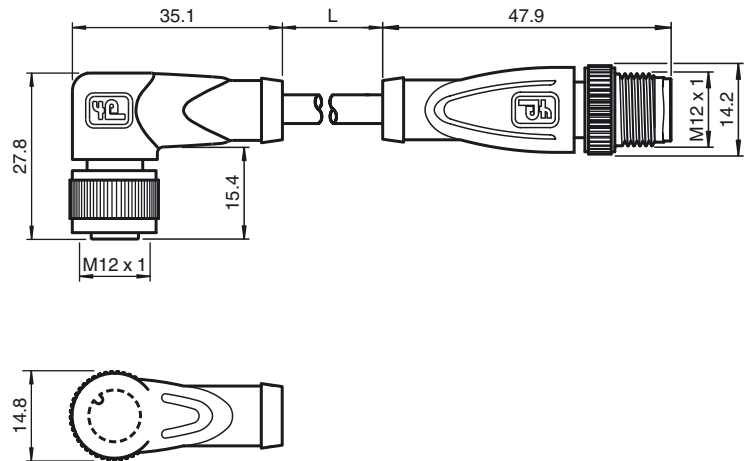

Technical data

General specifications

Number of pins	4
UL File Number	E231213

Electrical specifications

Operating voltage	U_B	max. 250 V AC/DC
Test voltage		> 1500 V _{eff} AC
Operating current	I_B	max. 4 A
Volume resistance		< 5 mΩ

Ambient conditions

Ambient temperature	-40 ... 90 °C (-40 ... 194 °F) cable, fixed: -40 ... 80 °C (-40 ... 176 °F) cable, flexing: -20 ... 80 °C (-4 ... 176 °F)
Pollution Degree	3

Mechanical specifications

Contact elements	spring-loaded contact socket
Pin diameter	1 mm
Degree of protection	IP67 / IP68 / IP69K

Material

Contacts	CuSn / Au
Contact surface	Au
Body	TPU, black
Cable	PUR
Slotted nut	Diecast zinc
Sleeve connector	Diecast zinc
Core insulation	PP
Cable	extra-fine wire, flexible
Sheath diameter	Ø 4.3 mm
Bending radius	> 10 x cable diameter, moving > 5 x cable diameter, fixed
Color	black
Cores	4 x 0.34 mm ²
Conductor construction	42 x 0.1 mm Ø
Length	L 5 m

Drag chain suitability

Drag chain cycles	≥ 5000000
Motion velocity	≤ 3.3 m/s
Torsional stress	± 180 °/m

Flammability

Contact material	94 HB
Housing	94 V-2
Cable	FT2

Compliance with standards and directives

Standard conformity	
---------------------	--

Electrical connection

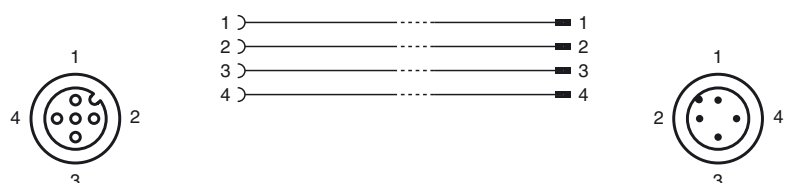

Release date: 2015-01-12 14:02 Date of issue: 2015-01-12 219129_eng.xml

Degree of protection	EN 60529:2000
Standards	IEC 61076-2-101:2008
Flammability	Body: UL 94 Line: UL 1581 Section 1061; IEC 60332-1-2:2004
Halogen-free	IEC 60754-1:1994

Approvals and certificates

UL approval	cURus AWM 20549 AWM I/II A/B 80°C 300V FT2 (cable)
Maximum permissible operating voltage	≤ 30 V
Maximum permissible ambient temperature	≤ 80 °C (≤ 176 °F)

Release date: 2015-01-12 14:02 Date of issue: 2015-01-12 219129_eng.xml