



Figure similar

ACCESSORY FOR FUSE SWITCH DISCONNECTOR
FOR NH1 FUSE CARRIER FUSE MONITORING
ELECTROMECHANICAL

Model	
product brand name	SETRON
Design of the product	for 3NP1 fuse switch disconnectors, fuse carrier with electromechanical fuse monitoring MFM, for size NH1

Accessories	
accessories	cover

General Product Approval	Declaration of Conformity	Test Certificates
--------------------------	---------------------------	-------------------



[Type Test Certificates/Test Report](#)

Further information

Information- and Downloadcenter (Catalogs, Brochures,...)

<http://www.siemens.com/lowvoltage/catalogs>

Industry Mall (Online ordering system)

<https://eb.automation.siemens.com/mall/en/WW/Catalog/Product/3NP19431GB10>

Service&Support (Manuals, Certificates, Characteristics, FAQs,...)

<http://support.automation.siemens.com/WW/view/en/3NP19431GB10/all>

Image database (product images, 2D dimension drawings, 3D models, device circuit diagrams, ...)

http://www.automation.siemens.com/bilddb/cax_en.aspx?mlfb=3NP19431GB10

CAX-Online-Generator

<http://www.siemens.com/cax>

Tender specifications

<http://ausschreibungstexte.siemens.com/tiplv>

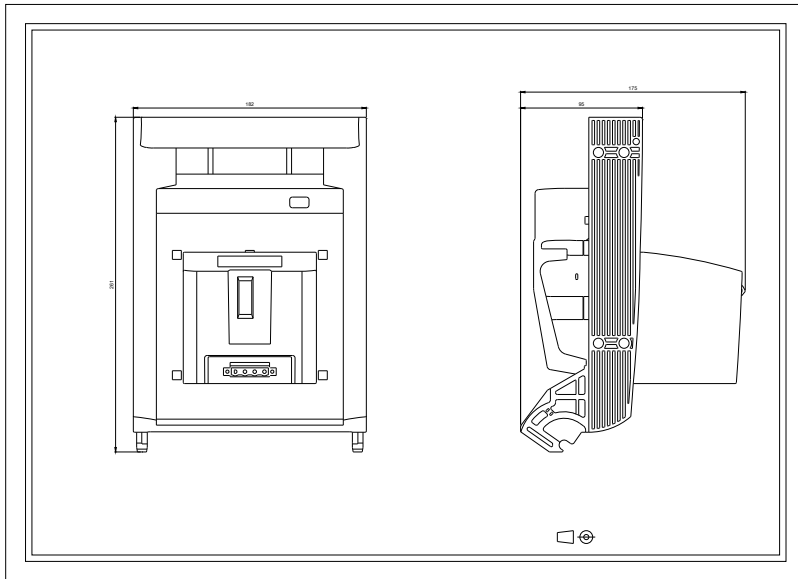

last modified:

11.03.2015