



2M Series Technical Information

Inserts Arrangements

Technical Reference

SERIES 2M INSERT ARRANGEMENTS

CONTACT SIZE	CONTACT QUANTITY					INSERT ARRANGEMENT			
	#23	#20	#20HD	#16	#12	2M801	2M803	2M804	2M805
Size #23 Contacts 5 Amp Max. Current 500 VAC #22-#28 AWG	3					5-3	5-3	5-3	NA
	4					6-4	6-4	6-4	8-4
	6					6-6	6-6	6-6	8-6
	7					6-7	6-7	6-7	8-7
	10					7-10	7-10	7-10	9-10
	13					8-13	8-13	8-13	10-13
	19					9-19	9-19	9-19	11-19
	26					10-26	10-26	10-26	12-26
	37					13-37	12-37	12-37	15-37
	55					16-55	14-55	14-55	18-55
	85					17-85	15-35	15-85	19-85
130					21-130	NA	NA	23-130	
Size #20HD Contacts 7.5 Amp Max. Current 750 VAC #20-#24 AWG.			3			6-23	6-23	6-23	8-23
			5			7-25	7-25	7-25	9-25
			8			8-28	8-28	8-28	10-28
			10			9-210	9-210	9-210	11-210
			20			13-220	12-220	12-220	15-220
			35			16-235	14-235	14-235	18-235
			41			17-241	NA	NA	19-241
		69			21-269	NA	NA	23-269	
Size #16 Contacts 13 Amp Max. Current 1800 VAC #16-#20 AWG				1		6-1	6-1	6-1	8-1
				2		8-2	8-2	8-2	10-2
				4		9-4	9-4	9-4	11-4
				5		10-5	10-5	10-5	12-5
				7		13-7	12-7	12-7	15-7
				12		16-12	14-12	14-12	18-12
				14		17-14	15-14	15-14	19-14
				22		21-22	NA	NA	23-22
Size #12 Contacts 23 Amp Max. Current 1800 VAC #12-14 AWG					1	7-1	7-1	7-1	9-1
					2	10-2	10-2	10-2	12-2
					2	13-2	12-2	12-2	15-2
					3	13-3	12-3	12-3	15-3
					5	16-5	14-5	14-5	18-5
					7	17-7	15-7	15-7	19-7
					12	21-12	NA	NA	23-12
Insert Arrangements with Mixed Size (Combo) Layouts	4	2				8-200	8-200	8-200	10-200
	8	2				9-201	9-201	9-201	11-201
	4		2			9-200	9-200	9-200	11-200
	8		2			10-202	10-202	10-202	12-202
	4			2		10-201	10-201	10-201	12-201
	6			2		13-200	12-200	12-200	15-200
	10			2		13-201	12-201	12-201	15-201
	12			1		10-200	10-200	10-200	12-200

Insert Arrangements

Front face of pin inserts illustrated (Socket Reversed)

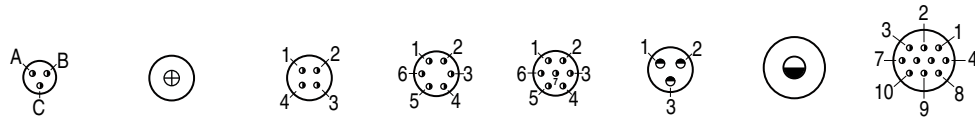

	2M801	2M803	2M804	5-3	6-1	6-4	6-6	6-7	6-23	7-1	7-10
2M805				NA	8-1	8-4	8-6	8-7	8-23	9-1	9-10
No. of Contacts				3	1	4	6	7	3	1	10
Contact Size				#23	#16	#23	#23	#23	#20HD	#12	#23
DWV Voltage (VAC)				500	1800	500	500	500	750	1800	500
Current Rating (Amps)				5	13	5	5	5	7.5	23	5

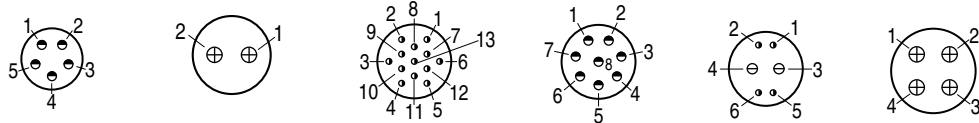

	2M801	2M803	2M804	7-25	8-2	8-13	8-28	8-200		9-4
2M805				9-25	10-2	10-13	10-28	10-200		11-4
No. of Contacts				5	2	13	8	2	4	4
Contact Size				#20HD	#16	#23	#20HD	#20	#23	#16
DWV Voltage (VAC)				750	1800	500	750	1000	500	1800
Current Rating (Amps)				7.5	13	5	7.5	7	5	13

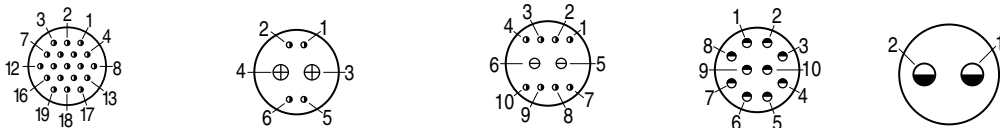

	2M801	2M803	2M804	9-19	9-200		9-201		9-210		10-2
2M805				11-19	11-200		11-201		11-210		12-2
No. of Contacts				19	2	4	2	8	10		2
Contact Size				#23	#16	#23	#20	#23	#20HD		#12
DWV Voltage (VAC)				500	1800	500	1000	500	750		1800
Current Rating (Amps)				5	13	5	7.5	5	7.5		23

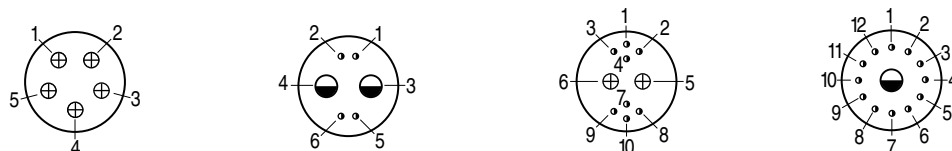

	2M801	2M803	2M804	10-5	10-201		10-202		10-200	
2M805				12-5	12-201		12-202		12-200	
No. of Contacts				5	2	4	2	8	1	12
Contact Size				#16	#12	#23	#16	#23	#12	#23
DWV Voltage (VAC)				1800	1800	500	1800	500	1800	500
Current Rating (Amps)				13	23	5	13	5	23	5

Insert Arrangements

Front face of pin inserts illustrated (Socket Reversed)

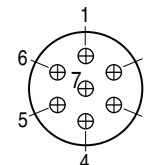
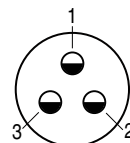
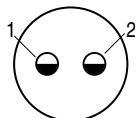
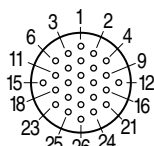

2M801	10-26	13-2	13-3	13-7
2M803 2M804	10-26	12-2	12-3	12-7
2M805	12-26	15-2	15-3	15-7
No. of Contacts	26	2	3	7
Contact Size	#23	#12	#12	#16
DWV Voltage (VAC)	500	1800	1800	1800
Current Rating (Amps)	5	23	23	13

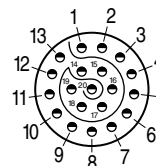
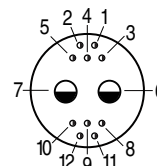
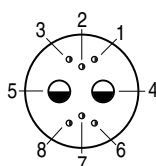
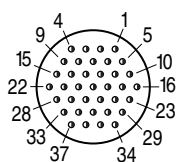

2M801	13-37	13-200		13-201		13-220
2M803 2M804	12-37	12-200		12-201		12-220
2M805	15-37	15-200		15-201		15-220
No. of Contacts	37	2	6	2	10	20
Contact Size	#23	#12	#23	#12	#23	#20HD
DWV Voltage (VAC)	500	1800	500	1800	500	750
Current Rating (Amps)	5	23	5	23	5	7.5

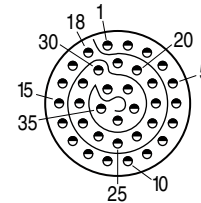
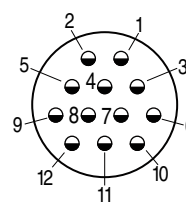
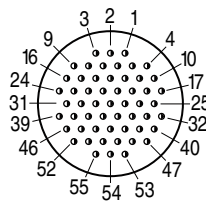
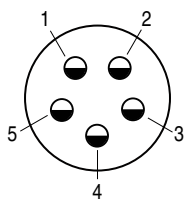

2M801	16-5	16-55	16-12	16-235
2M803 2M804	14-5	14-55	14-12	14-235
2M805	18-5	18-55	18-12	18-235
No. of Contacts	5	55	12	35
Contact Size	#12	#23	#16	#20HD
DWV Voltage (VAC)	1800	500	1800	750
Current Rating (Amps)	23	5	13	7.5

Insert Arrangements

Front face of pin inserts illustrated (Socket Reversed)

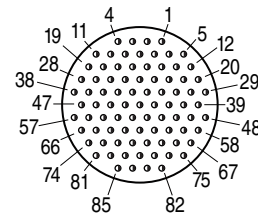
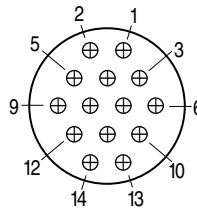
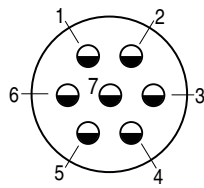

2M801	17-7	17-14	17-85
2M803 2M804	15-7	15-14	15-85
2M805	19-7	19-14	19-85
No. of Contacts	7	14	85
Contact Size	#12	#16	#23
DWV Voltage (VAC)	1800	1800	500
Current Rating (Amps)	23	13	5

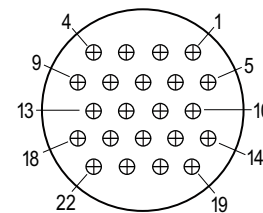
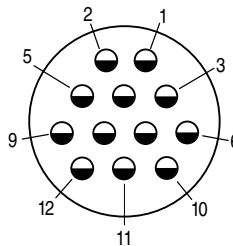
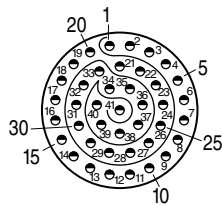



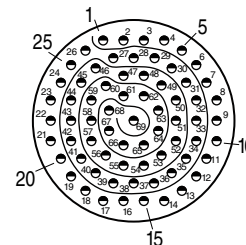
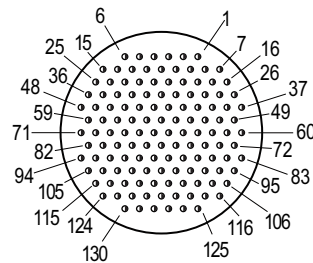



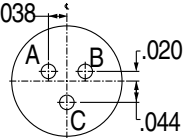
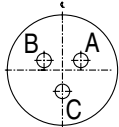

2M801	17-241	21-12	21-22
2M805	19-241	23-12	23-22
No. of Contacts	41	12	22
Contact Size	#20HD	#12	#16
DWV Voltage (VAC)	750	1800	1800
Current Rating (Amps)	7.5	23	13

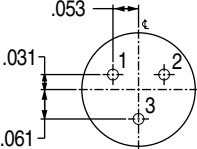
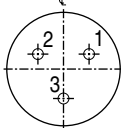

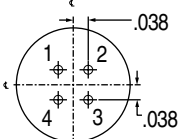
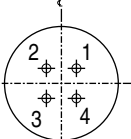

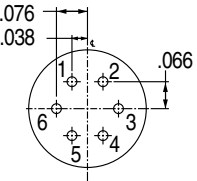
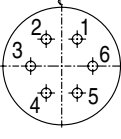
2M801	21-130	21-269
2M805	23-130	23-269
No. of Contacts	130	69
Contact Size	#23	#20HD
DWV Voltage (VAC)	500	750
Current Rating (Amps)	5	7.5

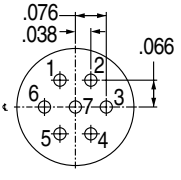
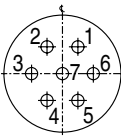
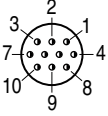
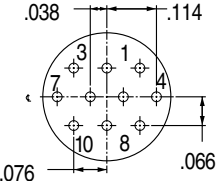
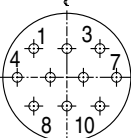
Straight PCB Footprints

INSERT ARRANGEMENT	PIN CONNECTOR	SOCKET CONNECTOR
 <p>5-3 (3) #23 Contacts .022 Max. Dia Tail</p>		
 <p>6-23, 8-23 (3) #20HD Contacts .023 Max. Dia. Tail</p>		
 <p>6-4, 8-4 (4) #23 Contacts .022 Max. Dia Tail</p>		
 <p>6-6, 8-6 (6) #23 Contacts .022 Max. Dia. Tail</p>		
 <p>6-7, 8-7 (7) #23 Contacts .022 Max. Dia. Tail</p>		
 <p>7-10, 9-10 10 #23 Contacts .022 Max. Dia. Tail</p>		

Socket inserts are a mirror image of pin side. Socket side shown for cavity locations only, reference pin side for dimensions.

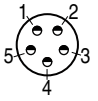
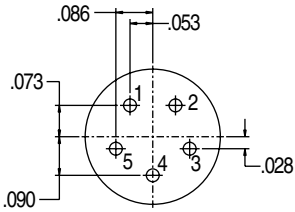
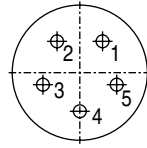
Straight PCB Footprints

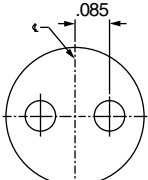
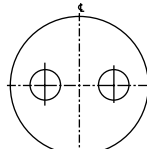
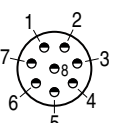
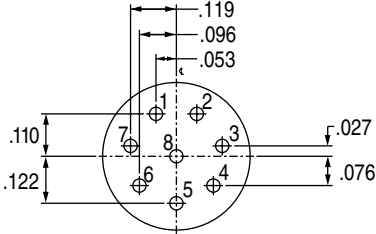
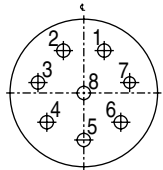
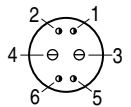
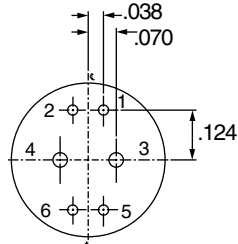
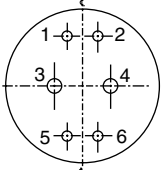
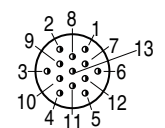
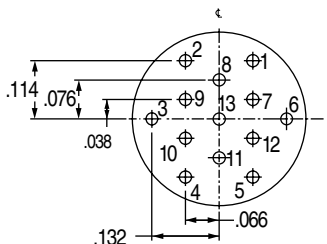
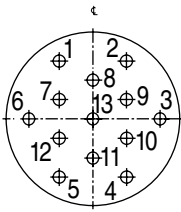
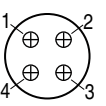
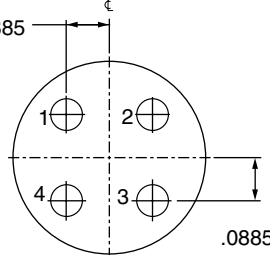
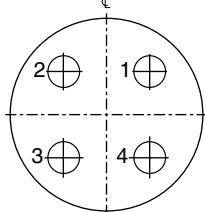
INSERT ARRANGEMENT	PIN CONNECTOR	SOCKET CONNECTOR
 <p>7-25, 9-25 (5) #20HD Contacts .028 Max. Dia Tail</p>		
 <p>8-2, 10-2 (2) #16 Contacts</p>		
 <p>8-28, 10-28 (8) #20HD Contacts</p>		
 <p>8-200, 10-200 (2) #20 Contacts (4) #23 Contacts</p>		
 <p>8-13, 10-13 (13) #23 Contacts .022 Max. Dia. Tail</p>		
 <p>9-4, 11-4 (4) #16 Contacts</p>		

Straight PCB Footprints

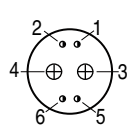
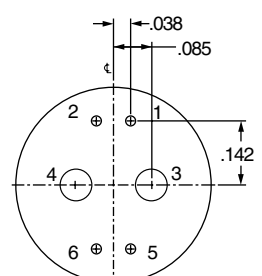
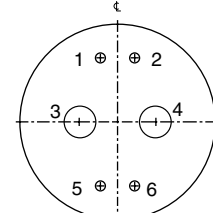
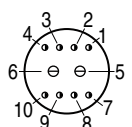
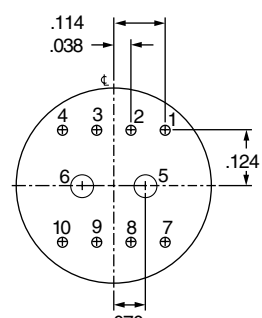
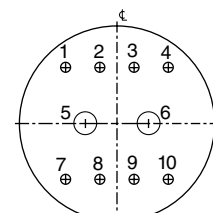
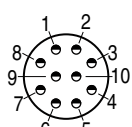
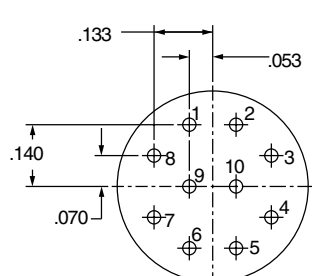
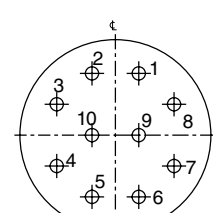
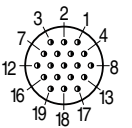
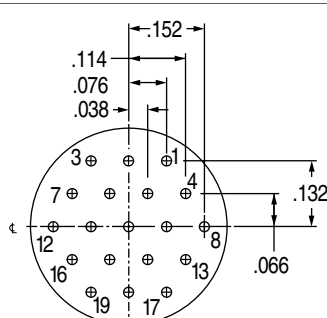
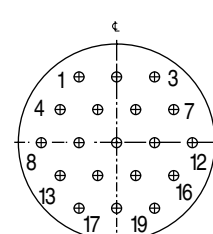
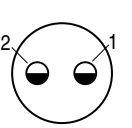
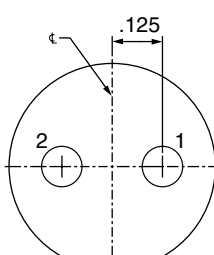
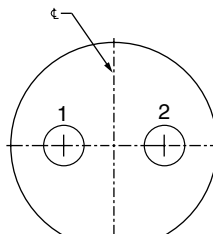
INSERT ARRANGEMENT	PIN CONNECTOR	SOCKET CONNECTOR
 <p>9-200, 11-200 (4) #23 Contacts (2) #16 Contacts</p>		
 <p>9-201, 11-201 (2) #20 Contacts (8) #23 Contacts</p>		
 <p>9-210, 11-210 (10) #20HD Contacts</p>		
 <p>9-19, 11-19 (19) #23 Contacts .022 Max. Dia Tail</p>		
 <p>10-2, 12-2 (2) #12 Contacts</p>		

Straight PCB Footprints

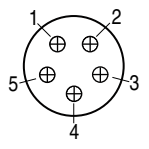
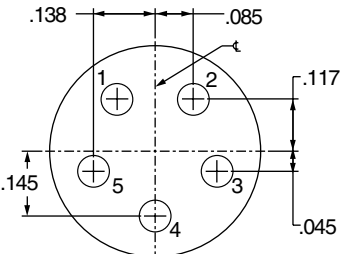
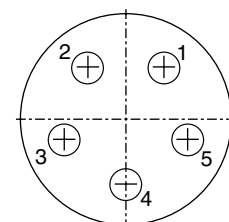
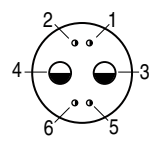
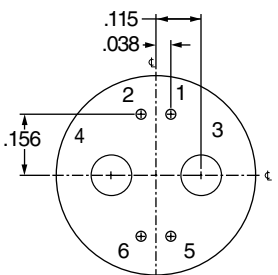
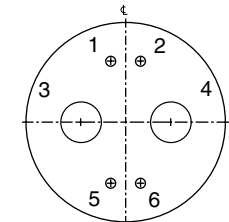
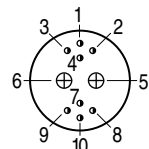
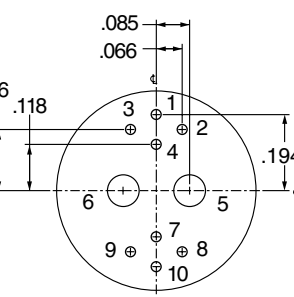
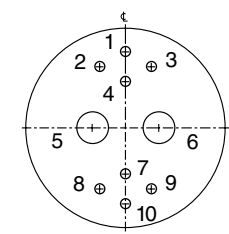
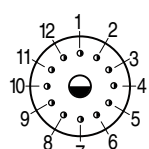
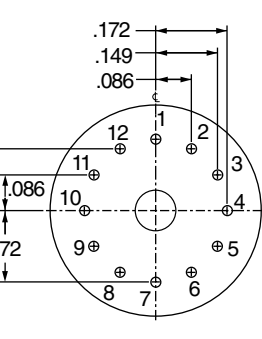
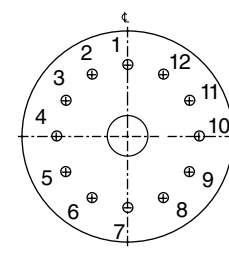
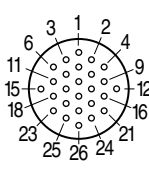
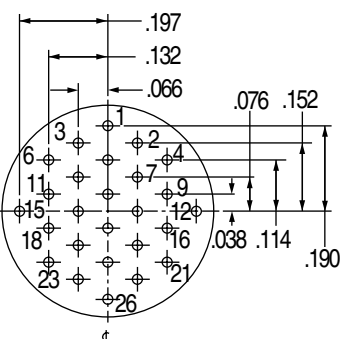
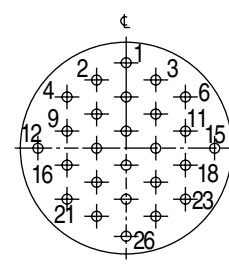
INSERT ARRANGEMENT	PIN CONNECTOR	SOCKET CONNECTOR
 <p>10-5, 12-5 (5) #16 Contacts</p>	 <p>.138 .085 .117 .145 .045</p>	
 <p>10-201, 12-201 (2) #12 Contacts (4) #23 Contacts</p>	 <p>.115 .038 .156</p>	
 <p>10-202, 12-202 (2) #16 Contacts (8) #23 Contacts</p>	 <p>.085 .066 .156 .118 .194</p>	
 <p>10-200, 10-200 (1) #12 Contact (12) #23 Contacts</p>	 <p>.172 .149 .086 .149 .086 .172</p>	
 <p>10-26, 12-26 (26) #23 Contacts .022 Max. Dia. Tail</p>	 <p>.197 .132 .066 .076 .152 .038 .114 .190</p>	

Straight PCB Footprints

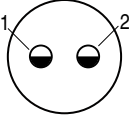
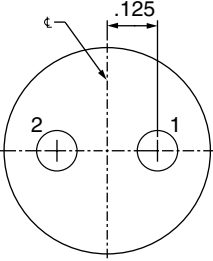
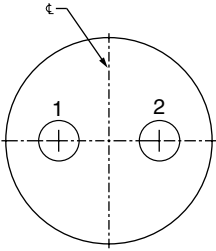
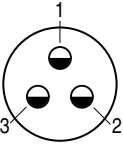
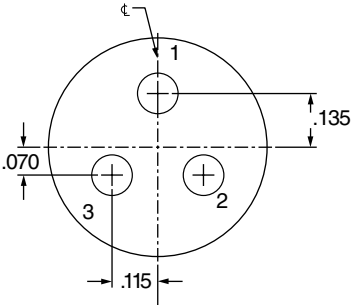
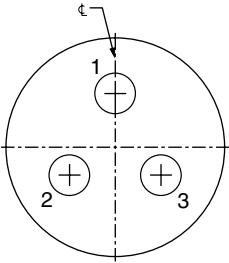
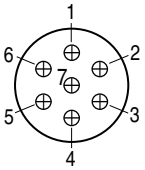
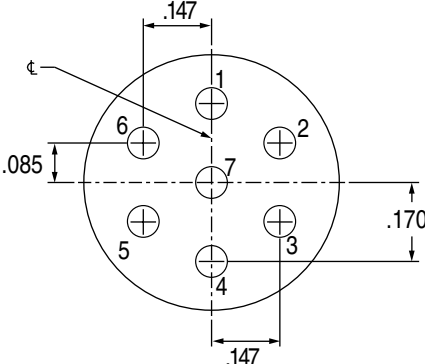
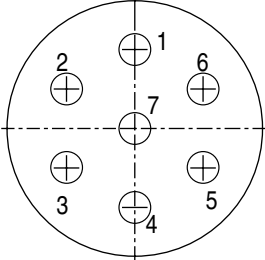
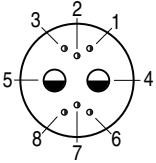
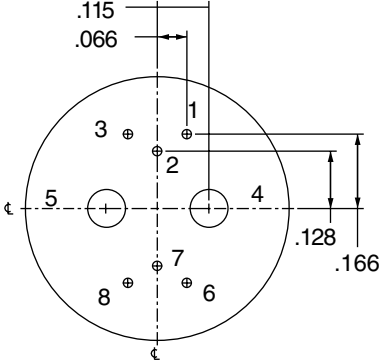
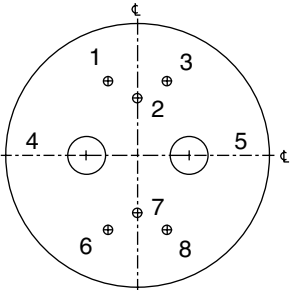
INSERT ARRANGEMENT	PIN CONNECTOR	SOCKET CONNECTOR
 <p data-bbox="241 541 402 590">12-2, 13-2, 15-2 (2) #12 Contacts</p>		
 <p data-bbox="241 919 402 972">12-3, 13-3, 15-3 (3) #12 Contacts</p>		
 <p data-bbox="241 1314 402 1367">12-7, 13-7, 15-7 (7) #16 Contacts</p>		
 <p data-bbox="207 1728 440 1801">12-200, 13-200, 15-200 (2) #12 Contacts (6) #23 Contacts</p>		

Straight PCB Footprints

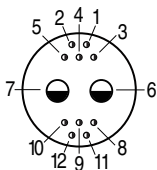
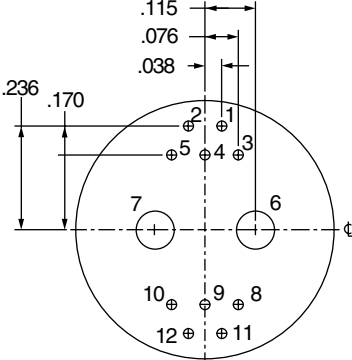
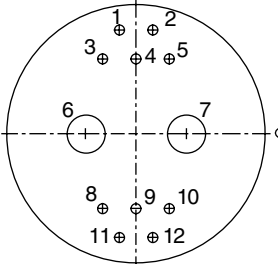
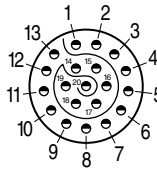
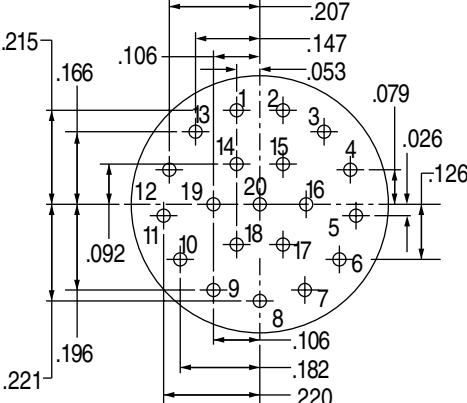
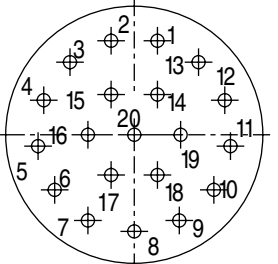
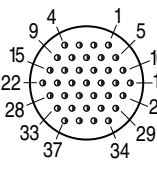
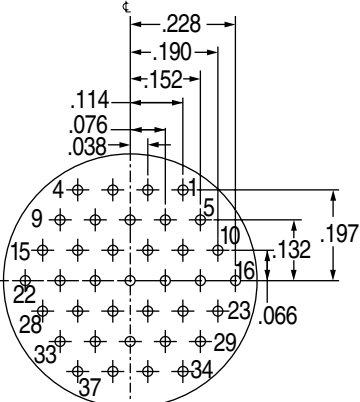
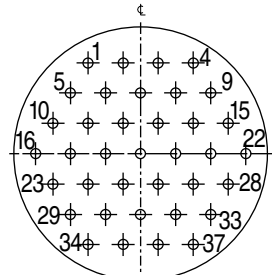
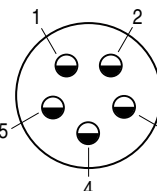
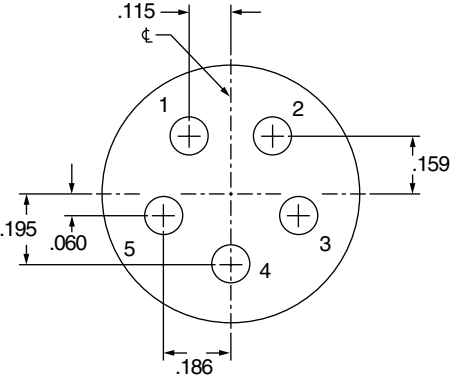
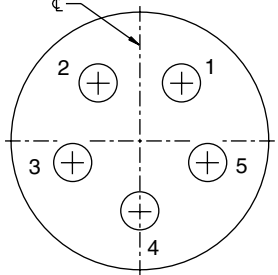
INSERT ARRANGEMENT	PIN CONNECTOR	SOCKET CONNECTOR
 <p>12-201, 13-201, 15-201 (2) #12 Contacts (10) #23 Contacts</p>		
 <p>12-220, 13-220, 15-220 (20) #20HD Contacts</p>		
 <p>12-37, 13-37, 15-37 (37) #23 Contacts .022 Max. Dia. Tail</p>		
 <p>14-5, 16-5, 18-5 (5) #12 Contacts</p>		

Straight PCB Footprints

INSERT ARRANGEMENT	PIN CONNECTOR	SOCKET CONNECTOR
<p>14-12, 16-12, 18-12 (12) #16 Contacts</p>	<p>Dimensions: .255, .170, .085, .241, .094, .054, .201</p>	
<p>14-55, 16-55, 18-55 (55) #23 Contacts .022 Max. Dia. Tail</p>	<p>Dimensions: .266, .190, .114, .038, .076, .152, .228, .066, .132, .197, .263</p>	
<p>14-235, 16-235, 18-235 (35) #20HD Contacts .023 Max. Dia. Tail</p>		

14-235, 16-235, 18-235

Pin. No.	X		Y		Pin. No.	X		Y		Pin. No.	X		Y	
	in.	mm.	in.	mm.		in.	mm.	in.	mm.		in.	mm.	in.	mm.
1	-.053	-1.35	.301	7.65	13	-.234	-5.94	-.196	-4.98	25	.000	0.00	-.209	-5.31
2	.053	1.35	.301	7.65	14	-.287	-7.29	-.104	-2.64	26	-.100	-2.54	-.172	-4.37
3	.153	3.89	.264	6.71	15	-.305	-7.75	.000	0.00	27	-.181	-4.60	-.104	-2.64
4	.234	5.94	.196	4.98	16	-.287	7.29	.104	2.64	28	-.199	-5.05	.000	0.00
5	.287	7.29	.104	2.64	17	-.234	-5.94	.196	4.98	29	-.181	-4.60	.104	2.64
6	.305	7.75	.000	0.00	18	-.153	-3.89	.264	6.71	30	-.100	-2.54	.172	4.37
7	.287	7.29	-.104	-2.64	19	.000	0.00	.209	5.31	31	-.053	-1.35	.073	1.85
8	.234	5.94	-.196	-4.98	20	.100	2.54	.172	4.37	32	.053	1.35	.073	1.85
9	.153	3.89	-.264	-6.71	21	.181	4.60	.104	2.64	33	.086	2.18	-.028	-0.71
10	.053	1.35	-.301	-7.65	22	.199	5.05	.000	0.00	34	.000	0.00	-.090	-2.29
11	-.053	-1.35	-.301	-7.65	23	.181	4.60	-.104	-2.64	35	-.086	-2.18	-.028	-0.71
12	-.153	-3.89	-.264	-6.71	24	.100	2.54	-.172	-4.37					

Straight PCB Footprints

INSERT ARRANGEMENT	PIN CONNECTOR	SOCKET CONNECTOR
<p>15-7, 17-7, 19-7 (7) #12 Contacts</p>		
<p>15-14, 17-14, 19-14 (14) #16 Contacts</p>		
<p>15-241, 16-241, 18-241 (41) #20HD Contacts .028 Max. Dia. Tail</p>		

15-241, 16-241, 18-241

Pin. No.	X		Y		Pin. No.	X		Y		Pin. No.	X		Y	
	in.	mm.	in.	mm.		in.	mm.	in.	mm.		in.	mm.	in.	mm.
1	-.053	-1.35	.335	8.51	15	-.302	-7.67	-.154	-3.91	29	-.151	-3.84	-.171	-4.34
2	.053	1.35	.335	8.51	16	-.335	-8.51	-.053	-1.35	30	-.213	-5.41	-.081	-2.06
3	.154	3.91	.302	7.67	17	-.335	-8.51	.053	1.35	31	-.226	-5.74	.028	0.71
4	.240	6.10	.240	6.10	18	-.302	-7.67	.154	3.91	32	-.188	-4.78	.130	3.30
5	.302	7.67	.154	3.91	19	-.240	-6.10	.240	6.10	33	-.106	-2.69	.202	5.13
6	.335	8.51	.053	1.35	20	-.154	-3.91	.302	7.67	34	-.053	-1.35	.110	2.79
7	.335	8.51	-.053	-1.35	21	.000	0.00	.228	5.79	35	.053	1.35	.110	2.79
8	.302	7.67	-.154	-3.91	22	.106	2.69	.202	5.13	36	.119	3.02	.027	0.69
9	.240	6.10	-.240	-6.10	23	.188	4.78	.130	3.30	37	.096	2.44	-.076	-1.93
10	.154	3.91	-.302	-7.67	24	.226	5.74	.028	0.71	38	.000	0.00	-.122	-3.10
11	+.053	+1.35	-.335	-8.51	25	.213	5.41	-.081	-2.06	39	-.096	-2.44	-.076	-1.93
12	-.053	-1.35	-.335	-8.51	26	.151	3.84	-.171	-4.34	40	-.119	-3.02	.027	0.69
13	-.154	-3.91	-.302	-7.67	27	.055	1.40	-.222	-5.64	41	.000	0.00	.000	0.00
14	-.240	-6.10	-.240	-6.10	28	-.055	-1.40	-.222	-5.64					

Straight PCB Footprints

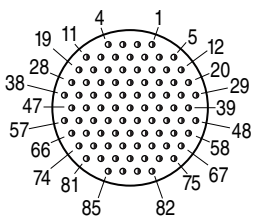
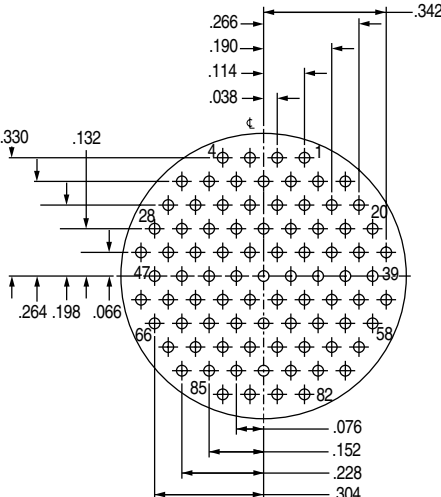
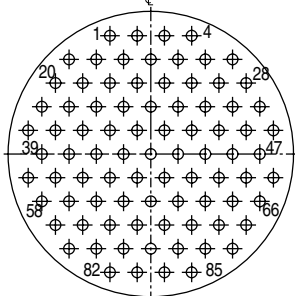
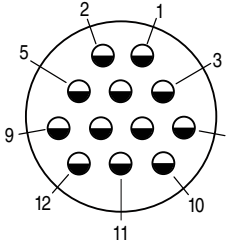
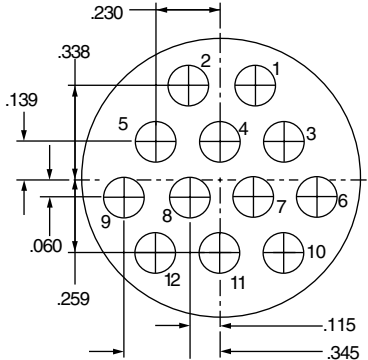
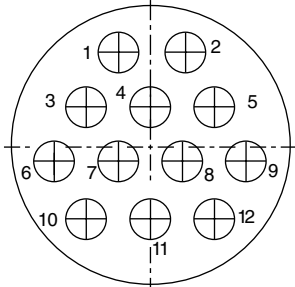
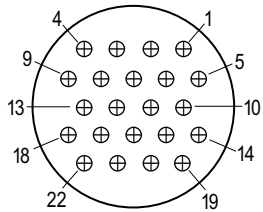
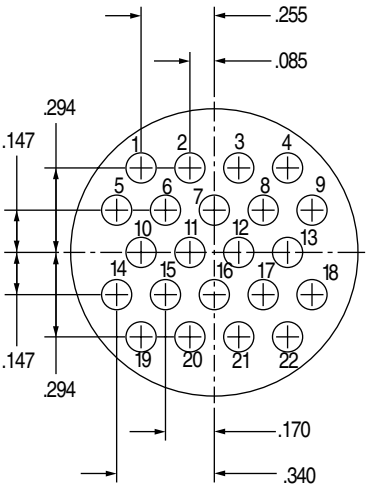
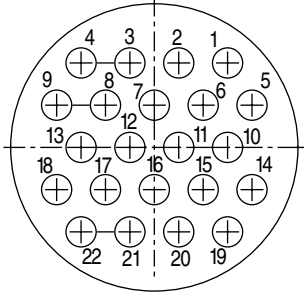
INSERT ARRANGEMENT	PIN CONNECTOR	SOCKET CONNECTOR
 <p>17-85, 19-85 (85) #23 Contacts .022 Max. Dia. Tail</p>		
 <p>21-12, 23-12 (12) #12 Contacts</p>		
 <p>21-22, 23-22 (22) #16 Contacts</p>		

Straight PCB Footprints

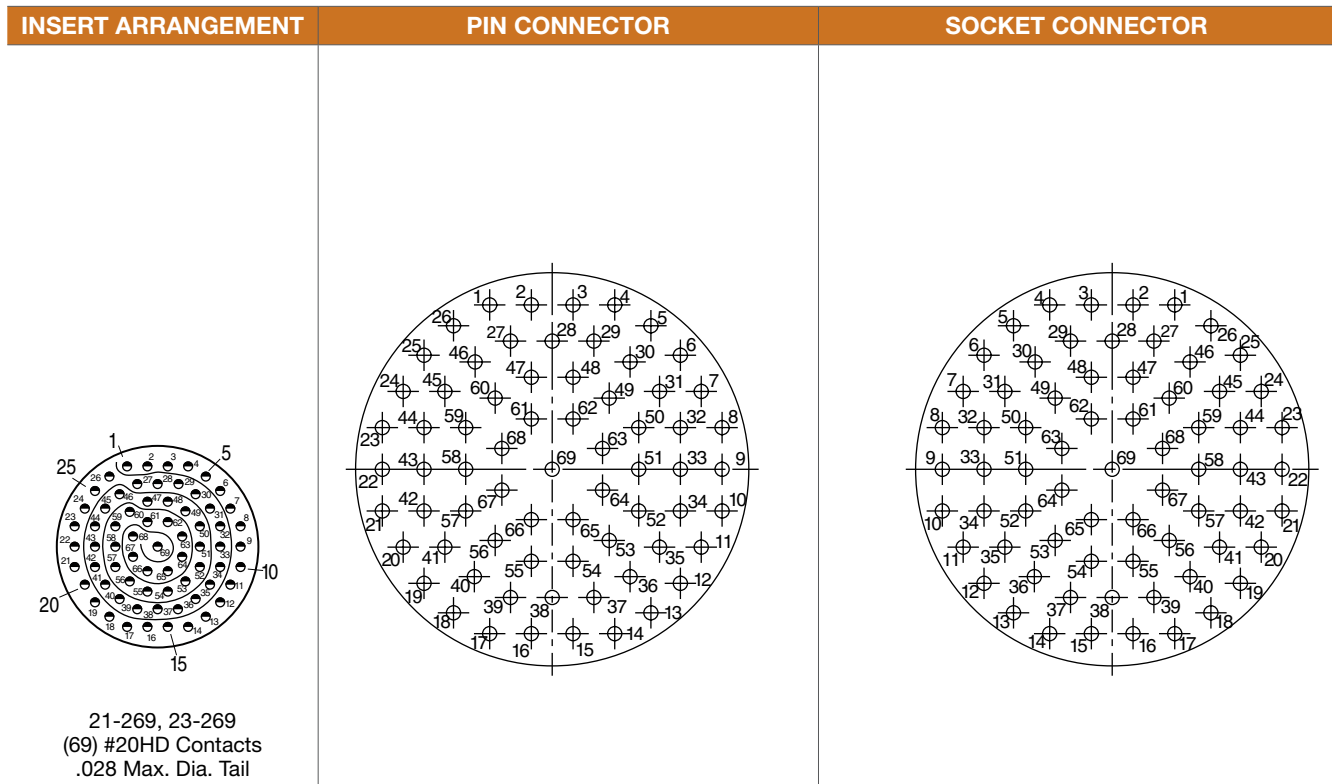

21-269, 23-269														
Pin. No.	X		Y		Pin. No.	X		Y		Pin. No.	X		Y	
	in.	mm.	in.	mm.		in.	mm.	in.	mm.		in.	mm.	in.	mm.
1	-.159	-4.04	.418	10.62	24	-.379	-9.63	.198	5.03	47	-.053	-1.35	.234	5.94
2	-.053	-1.35	.418	10.62	25	-.326	-8.28	.290	7.37	48	.053	1.35	.234	5.94
3	.053	1.35	.418	10.62	26	-.251	-6.38	.365	9.27	49	.145	3.68	.181	4.60
4	.159	4.04	.418	10.62	27	-.106	-2.69	.326	8.28	50	.220	5.59	.106	2.69
5	.251	6.38	.365	9.27	28	.000	0.00	.326	8.28	51	.220	5.59	.000	0.00
6	.326	8.28	.290	7.37	29	.106	-2.69	.326	8.28	52	.220	5.59	-.106	-2.69
7	.379	9.63	.198	5.03	30	.198	5.03	.273	6.93	53	.145	3.68	-.181	-4.60
8	.432	10.97	.106	2.69	31	.273	6.93	.198	5.03	54	.053	1.35	-.234	-5.94
9	.432	10.97	.000	0.00	32	.326	8.28	.106	2.69	55	-.053	-1.35	-.234	-5.94
10	.432	10.97	-.106	-2.69	33	.326	8.28	.000	0.00	56	-.145	-3.68	-.181	-4.60
11	.379	9.63	-.198	-5.03	34	.326	8.28	-.106	-2.69	57	-.220	-5.59	-.106	-2.69
12	.326	8.28	-.290	-7.37	35	.273	6.93	-.198	-5.03	58	-.220	-5.59	.000	0.00
13	.251	6.38	-.365	-9.27	36	.198	5.03	-.273	-6.93	59	-.220	-5.59	.106	2.69
14	.159	4.04	-.418	-10.62	37	.106	2.69	-.326	-8.28	60	-.145	-3.68	.181	4.60
15	.053	1.35	-.418	-10.62	38	.000	0.00	-.326	-8.28	61	-.053	-1.35	.128	3.25
16	-.053	-1.35	-.418	-10.62	39	-.106	-2.69	-.326	-8.28	62	.053	1.35	.128	3.25
17	-.159	-4.04	-.418	-10.62	40	-.198	-5.03	-.273	-6.93	63	.128	3.25	.053	1.35
18	-.251	-6.38	-.365	-9.27	41	-.273	-6.93	-.198	-5.03	64	.128	3.25	-.053	-1.35
19	-.326	-8.28	-.290	-7.37	42	-.326	-8.28	-.106	-2.69	65	.053	1.35	-.128	-3.25
20	-.379	-9.63	-.198	-5.03	43	-.326	-8.28	.000	0.00	66	-.053	-1.35	-.128	-3.25
21	-.432	-10.97	-.106	-2.69	44	-.326	-8.28	.106	2.69	67	-.128	-3.25	-.053	-1.35
22	.432	-10.97	.000	0.00	45	-.273	-6.93	.198	5.03	68	-.128	-3.25	.053	1.35
23	-.432	-10.97	.106	2.69	46	-.198	-5.03	.273	6.93	69	.000	0.00	.000	0.00

INSERT ARRANGEMENT

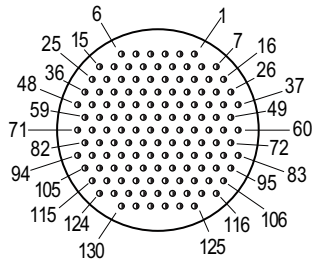

21-130, 23-130
(130) #23 Contacts
.022 Max. Dia Tail

PIN CONNECTOR

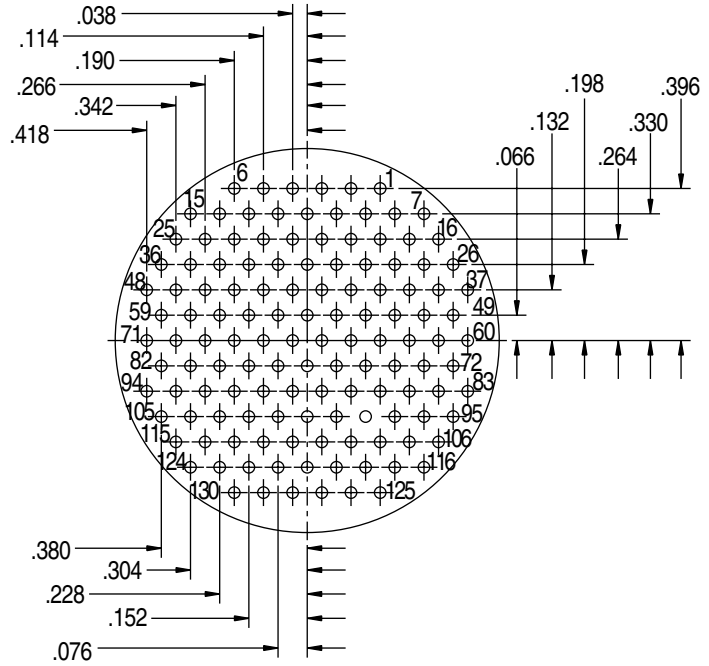

SOCKET CONNECTOR

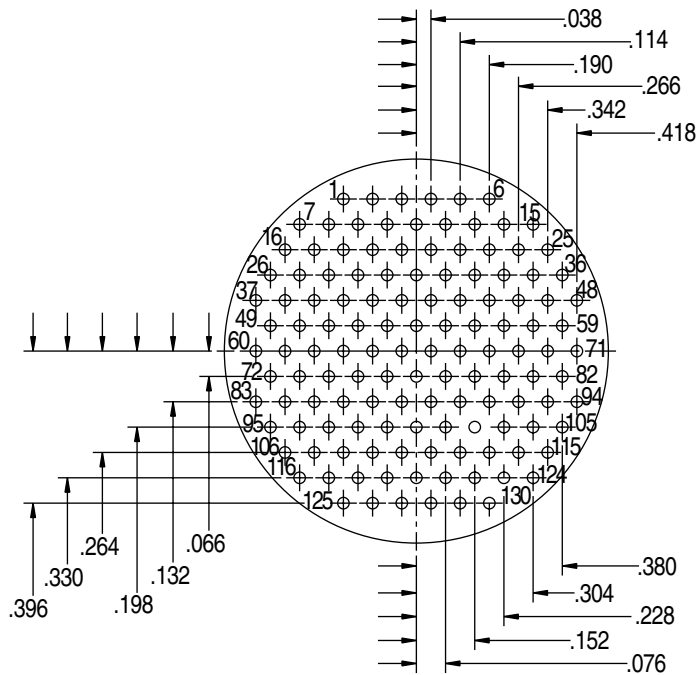

General Information

Page Guide

Order	D41
Weight	D42
Plugs	D43
Jam Nut Rear	D44
Jam Nut Front	D45
In-Line	D46
PCB/Jam Nut (R)	D47
PCB/Jam Nut (F)	D48
Panel Mt Plug	D49
Jam Nut Panel Mt	D50
Flange Mt Plug	D51
Protection Caps	D52-56

Amphenol's 2M Micro38999 Connector Series... The New Aerospace Standard

Averaging less than half the size and weight of their 38999 ancestors, Amphenol's 2M Micro38999 series are an easy and inexpensive way to take weight out of your system. 2M meet or exceed most environmental and performance requirements listed in MIL-DTL-38999, so modernizing your equipment doesn't mean sacrificing ruggedness. With almost 2,000,000 configurations in every termination style and a full complement of accessories available right out of the catalog, customization has never been easier. Smarter, faster and smaller: Amphenol's 2M... the only connector you'll ever need.

2M804 Features

- Push-pull coupling
- Excellent EMI shielding
- Rated to 38999 immersions
- Quick-disconnect



Why 2M804?

2M804 connectors are the most rugged push-pull connectors on the market. Designed for use in soldier-worn tactical equipment deployed by the United States military, these connectors were built to perform. Waterproof, dustproof, and highly resistant to EMI interference, these connectors are just as at home on the battlefield as they are in use on C4I and IFE systems. With up to 85 signals, panel-mounting options, and customizable separation forces, there's no place on land, sea, or air 2M804 can't go.

2M804 VS 38999

Specification	2M804	MIL-DTL 38999 Series III
Signal Count	1 to 85	1 to 187
Insulation Resistance	5,000 megaohms min	5,000 megaohms min
Operating Temperature	-65°C to +150°C	-65°C to +175°C
Shock	300 G ± 15	300 G ± 15
Vibration	"37.0 G Random 30.0 G Sine"	"43.9 G Random 60.0 G Sine"
Shielding Effectiveness	"40 dB min. from 100 MHz to 1000 MHz"	"65 dB min. from 100 MHz to 1000 MHz"
Durability	1,000 mating cycles min.	500 mating cycles
Shell to Shell Conductivity	2.5 mV drop max	2.5 mV drop max
Contacts	Per AS39029	Per AS39029

2M804 MATERIALS AND FINISHES

Shells	Aluminum Alloy or Stainless Steel
Contacts	Copper Alloy, gold plated
Insulators	Polyphenylene Sulfide (PPS)
Contact Retention	Beryllium Copper Alloy
Grommet, Interfacial Seal, O-Ring	Fluorosilicone Rubber
Canted Coil Spring	Stainless Steel, Gold plated



2M804 Push-Pull Crimp Receptacles

Ordering Guide for 2M804-001, 002, 003, 004



1. SERIES	2. SHELL STYLE	3. SERVICE CLASS	4. SHELL SIZE-INSERT ARRANGEMENT	5. CONTACTS	6. KEYING	7. SUFFIX
2M804-00X	-06	ZNU	6-7	P	A	

1. SERIES

Type	Part #	Description
CRIMP	PLUGS	
	2M804-001	Plug with Integral Backshell
	2M804-002	Plug with Accessory Threads
	RECEPTACLE	
	2M804-003	Receptacle with Integral Backshell
	2M804-004	Receptacle with Accessory Threads
PCB/SOLDER	PCB/SOLDER RECEPTACLES	
	2M804-005	Receptacle w/ Epoxy Potting
	2M804-020	Receptacle for Open Face Immersion
	PCB/SOLDER PLUGS	
	2M804-009	Plugs with Solder Cup or PCB termination with Standard Epoxy Potting
	2M804-021	Plugs with Solder Cup or PCB Termination with Special Sealing for Open Face (unmated) Water Immersion Requirements. 100% Leak Tested. To maintain a helium leak rate of 1×10^{-4} cc/sec. pressure differential from -65°C to 150°C.

2. SHELL STYLE RECEPTACLE

Part #	Description
PLUGS	
-06	Plug
RECEPTACLE	
-00	Jam Nut* for Front Panel
-01	In-Line
-07	Jam Nut* for Rear Panel
PCB/SOLDER RECEPTACLES	
-00	Jam Nut* for Front Panel Mounting
-07	Jam Nut* Rear Panel Mounting
PCB/SOLDER PLUGS	
-00	Jam Nut for Front Panel mounting
-07	Jam Nut for Rear Panel Mounting
-02	Flange Mount, Rear Panel

*add "-501" as a suffix to the Jam Nut Part number to include a Hex Nut instead of a Spanner Nut.

5. CONTACTS

Style	Part #	Description
CRIMP	P	Pin
	S	Socket
	A	Pin-Less Contacts
	B	Socket-Less Contacts

PCB/SOLDER

P	Pin-PCB
S	Socket-PCB
E	Pin-Solder Cup
F	Socket-Solder Cup

3. SERVICE CLASS

Material	Part #	Description	RoHS
ALUMINUM	C	Anodized (Non-conductive)	
	M	Electroless Nickel	
	NF	Olive Drab Cadmium	
	MT	Durmalon (Ni PTFE)	
	ZN	Olive Drab Zinc Nickel	
	ZNU	Black Zinc Nickel	
	STAINLESS STEEL	Z1	Passivated
ZM		Electroless Nickel	

4. SHELL SIZE-INSERT ARRANGEMENT

See Table on pages 7-20

6. KEYING*

Part #	A°	B°
A	150°	210°
B	75°	210°
C	95°	230°
D	140°	275°

*For single master key omit (leave blank)

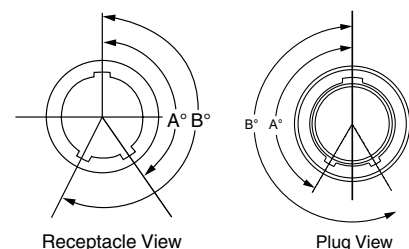



2M804 Push-Pull Quick-Disconnect

Connector Weights

SERIES 2M804 WEIGHTS IN GRAMS

Insert Arrg.	Plug	Jam Nut Receptacle		In-Line Receptacle
		Rear Mount	Front Mount	
5-3P	2.2	8.0	9.7	4.0
5-3S	2.4	8.3	9.8	4.1
6-1P	3.1	7.2	11.8	5.2
6-1S	3.4	7.5	12.1	5.5
6-4P	2.8	8.8	11.4	4.8
6-4S	3.0	9.0	11.6	5.1
6-7P	3.0	9.1	11.7	5.3
6-7S	3.2	9.5	12.0	5.5
7-1P	3.7	11.1	16.4	10.1
7-1S	4.3	11.7	16.9	10.7
7-10P	3.7	10.9	16.2	10.0
7-10S	4.2	11.3	16.5	10.3
8-2P	5.0	10.9	13.5	8.0
8-2S	5.7	5.7	11.7	9.0
8-13P	4.3	10.6	12.4	7.4
8-13S	4.8	11.0	13.0	8.1
8-200P	5.3	11.2	13.9	8.4
8-200S	6.1	12.0	14.6	9.1
9-4P	5.7	15.2	21.1	11.0
9-4S	6.7	16.2	22.1	12.0
9-19P	4.6	14.1	20.0	9.9
9-19S	4.8	14.9	21.1	9.8
9-200P	5.2	14.6	20.6	10.5
9-200S	6.3	15.7	21.7	11.6
9-201P	5.8	15.3	21.2	11.1
9-201S	6.9	16.4	22.3	12.2
10-5P	7.3	15.5	23.3	11.9
10-5S	8.7	16.9	24.8	13.3
10-26P	5.4	13.6	20.5	10.1
10-26S	6.2	13.9	21.1	10.5
10-200P	6.2	14.4	22.2	10.8
10-200S	7.6	15.8	23.7	12.2
10-201P	6.3	14.5	22.3	10.9
10-201S	7.7	16.0	23.8	12.3
10-202P	6.3	14.5	22.3	10.9
10-202S	7.8	16.1	23.9	12.4
12-2P	10.7	21.5	26.1	20.8
12-2S	12.3	23.1	27.7	22.4
12-3P	11.7	22.4	27.1	21.8
12-3S	13.4	24.2	28.8	23.4
12-7P	11.9	22.7	27.3	22.0

SERIES 2M804 WEIGHTS IN GRAMS

Insert Arrg.	Plug	Jam Nut Receptacle		In-Line Receptacle
		Rear Mount	Front Mount	
12-7S	14.5	25.3	29.9	24.6
12-37P	10.1	21.5	25.5	22.4
12-37S	11.8	23.1	27.2	22.1
12-200P	10.3	21.1	25.7	20.5
12-200S	12.5	23.3	27.9	22.7
12-201P	10.7	21.5	26.1	22.8
12-201S	13.0	23.8	28.4	23.1
14-5P	15.4	28.3	33.6	26.3
14-5S	18.4	31.2	36.5	29.3
14-12P	16.2	29.0	34.3	27.1
14-12S	19.8	32.7	38.0	30.7
14-55P	12.8	25.6	30.9	23.7
14-55S	15.6	28.3	33.8	26.5

SERIES 2M804 UNMATE FORCE

Layout	Average Force	
	Pounds	Newtons
5-3	10.6	47.1
6-4	10.8	48.0
6-7	11.4	50.7
7-10	12.0	53.4
8-13	12.6	56.0
9-19	13.8	61.4
10-26	15.2	67.6
12-37	17.4	77.4
14-55	21.0	93.4

Note: Contact Amphenol if modified force values are needed.

2M804

D

2M804 Push-Pull Plug Connector

2M804-001-06 and 2M804-002-06



2M804-001-06

2M804-002-06

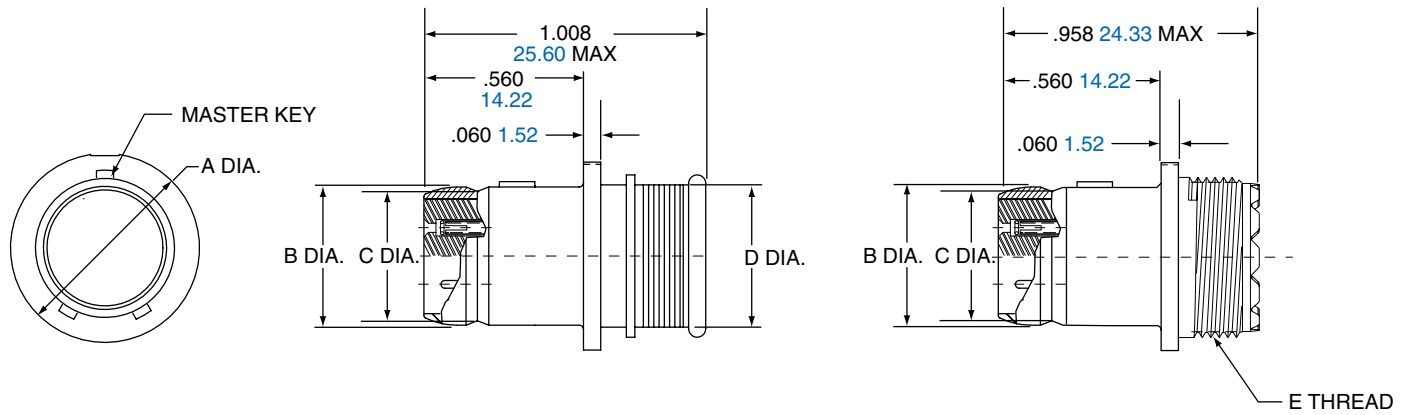

Shell Size	A Dia.		B Dia.		C Dia.		D Dia.		E Thread UNEF-2A
	in.	mm	in.	mm.	in.	mm	in.	mm.	
5	.418	10.62	.245	6.22	.218	5.54	.248	6.30	.2500-32
6	.488	12.40	.310	7.87	.275	6.99	.293	7.44	.3125-32
7	.561	14.25	.378	9.60	.350	8.89	.388	9.86	.4375-28
8	.603	15.32	.426	10.82	.395	10.03	.448	11.38	.5000-28
9	.663	16.84	.482	12.24	.450	11.43	.503	12.78	.5625-24
10	.743	18.87	.555	14.10	.525	13.34	.563	14.30	.6250-24
12	.851	21.62	.672	17.07	.642	16.31	.653	16.59	.6875-24
14	.978	24.84	.795	20.19	.761	19.33	.803	20.40	.9375-20
15	1.038	26.37	.863	21.92	.837	21.26	.853	21.67	.9375-20

2M804

D

2M804-004-07

2M804-003-07

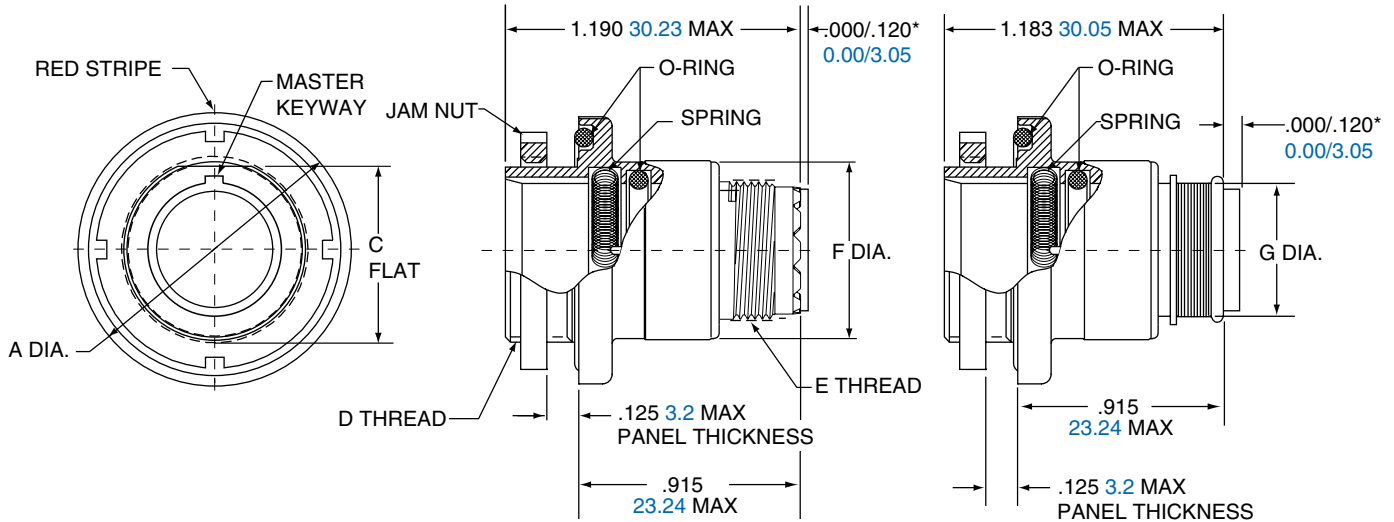

*Grommet protrudes for power/combo arrangements

Shell Size	A Dia.		C Flat		D Thread UN-2A	E Thread UNEF-2A	F Dia.		G Dia.	
	in.	mm.	in.	mm.			in.	mm.	in.	mm.
5	.773	19.63	.414	10.52	.4375-32	.2500-32	.448	11.38	.248	6.30
6	.833	21.16	.468	11.89	.5000-32	.3125-32	.513	13.03	.293	7.44
7	.903	22.94	.593	15.06	.6250-28	.4375-28	.573	14.55	.388	9.86
8	.958	24.33	.593	15.06	.6250-28	.5000-28	.596	15.14	.448	11.38
9	.998	25.35	.653	16.59	.6875-28	.5625-24	.691	17.55	.503	12.78
10	1.083	27.51	.721	18.31	.7500-28	.6250-24	.728	18.49	.563	14.30
12	1.183	30.05	.843	21.41	.8750-28	.6875-24	.883	22.43	.653	16.59
14	1.323	33.60	.968	24.59	1.0000-28	.9375-20	1.003	25.48	.803	20.40
15	1.373	34.87	1.036	26.31	1.0625-20	.9375-20	1.063	27.00	.853	21.67

JAM NUT PANEL CUTOUT

Shell Size	A Flat		B Dia.	
	in. ±.002	mm. ± 0.05	in. ±.005	mm. ± 0.13
5	.423	10.74	.448	11.38
6	.475	12.07	.510	12.95
7	.602	15.29	.635	16.13
8	.602	15.29	.635	16.13
9	.663	16.84	.698	17.73
10	.729	18.82	.760	19.30
12	.851	21.62	.885	22.48
14	.976	24.79	1.010	25.65
15	1.043	26.49	1.073	27.25

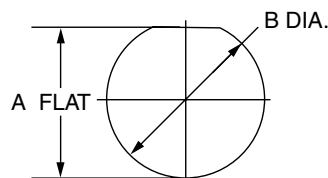

2M804 Push-Pull Jam Nut Front Panel Recept.



2M804-003-00 and 2M804-004-00

2M804-004-00

2M804-003-00

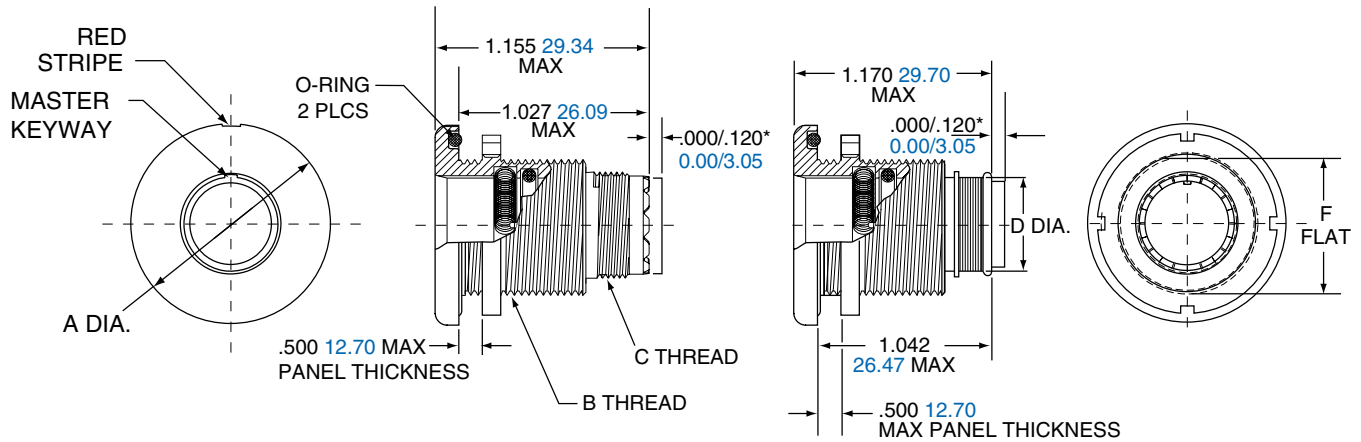

*Grommet protrudes for power/combo arrangements

Shell Size	A Dia.		B Thread UN-2A	C Thread UNEF-2A	D Dia.		F Flat.	
	in.	mm			in.	mm.	in.	mm.
5	.830	21.08	.5000-32	.2500-32	.248	6.30	.470	11.94
6	.884	22.45	.5625-32	.3125-32	.293	7.44	.529	13.44
7	.994	25.25	.6875-28	.4375-28	.388	9.86	.663	16.84
8	.994	25.25	.6875-28	.5000-28	.448	11.38	.663	16.84
9	1.073	27.25	.7500-28	.5625-24	.503	12.78	.719	18.26
10	1.138	28.91	.8125-28	.6250-24	.563	14.30	.778	19.76
12	1.338	33.96	1.0000-28	.6875-24	.653	16.59	.969	24.61
14	1.388	35.26	1.0625-20	.9375-20	.803	20.40	1.019	25.88
15	1.453	36.91	1.1250-28	.9375-20	.853	21.67	1.113	28.27

PANEL CUTOUT

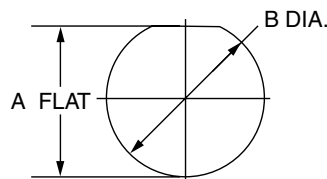

Shell Size	A Flat		B Dia.	
	in. ±.002	mm. ± 0.05	in. ±.005	mm. ± 0.13
5	.477	12.12	.510	12.95
6	.537	13.64	.573	14.55
7	.670	17.02	.698	17.73
8	.670	17.02	.698	17.73
9	.727	18.47	.760	19.30
10	.787	20.19	.823	20.90
12	.977	24.82	1.010	25.65
14	1.027	26.09	1.073	27.25
15	1.121	28.47	1.135	28.83

2M804-004-01

2M804-003-01

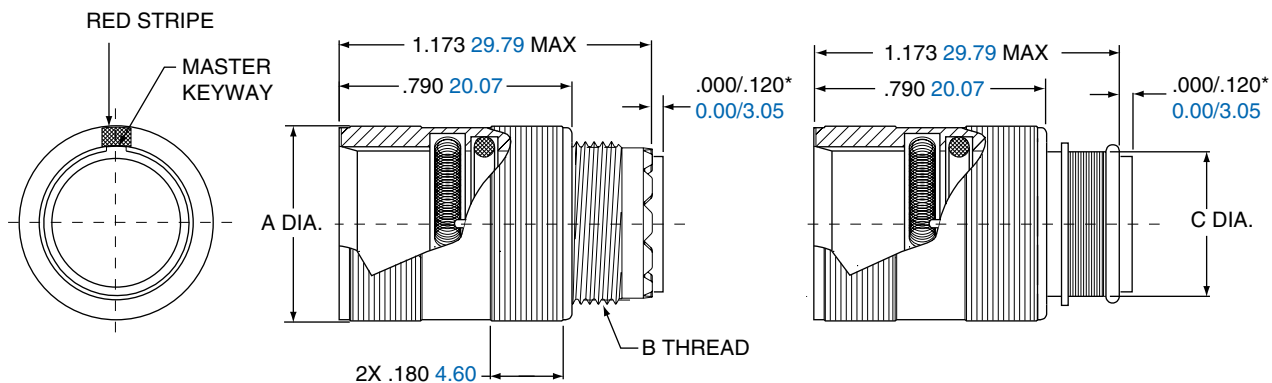

*Grommet protrudes for power/combo arrangements

Shell Size	A Dia.		B Thread UNEF-2A	C Dia.	
	in.	mm		in.	mm.
5	.453	11.51	.2500-32	.248	6.30
6	.523	13.28	.3125-32	.293	7.44
7	.583	14.81	.4375-28	.388	9.86
8	.606	15.39	.5000-28	.448	11.38
9	.698	17.73	.5625-24	.503	12.78
10	.738	18.75	.6250-24	.563	14.30
12	.883	22.43	.6875-24	.653	16.59
14	1.013	25.73	.9375-20	.803	20.40
15	1.061	26.95	.9375-20	.853	21.67

2M804 PCB/ Solder Rear Panel Jam Nut Recpt.



2M804-005-07 and 2M804-020-07

2M804-005-07
2M804-020-07

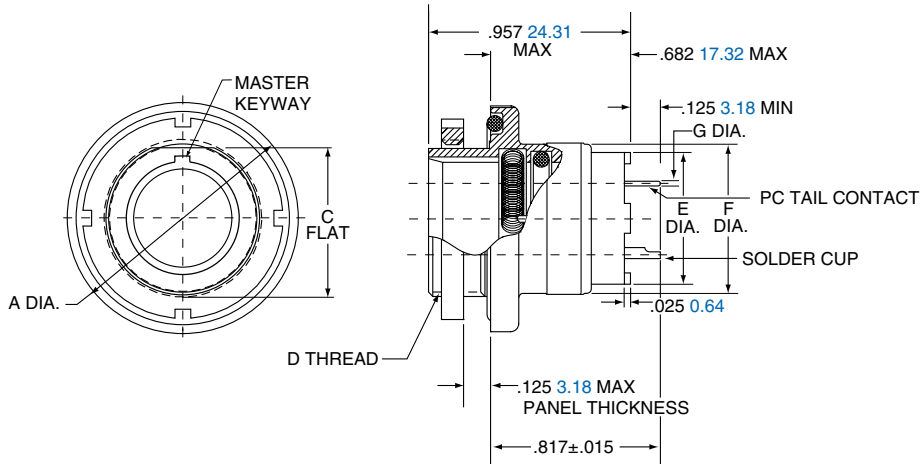

Shell Size	A Dia.		C Flat		D Thread UN-2A	E Dia.		F Dia.		G PC Tail Dia.
	in.	mm.	in.	mm.		in.	mm.	in.	mm.	
5	.773	19.63	.414	10.52	.4375-32	.274	6.96	.448	11.38	#23 .018/.022 0.46/0.56
6	.833	21.16	.468	11.89	.5000-32	.329	8.36	.513	13.03	
7	.903	22.94	.593	15.06	.6250-28	.431	10.95	.573	14.55	#20/20HD .025/.027 0.64/0.69
8	.958	24.33	.593	15.06	.6250-28	.493	12.52	.596	15.14	
9	.998	25.35	.653	16.59	.6875-28	.551	14.00	.691	17.55	#16 .060/.064 1.52/1.63
10	1.083	27.51	.721	18.31	.7500-28	.619	15.72	.728	18.49	
12	1.183	30.05	.843	21.41	.8750-28	.703	17.86	.883	22.43	
14	1.323	33.60	.968	24.59	1.0000-28	.863	21.92	1.003	25.48	#12 .092/.096 2.34/2.44
15	1.373	34.87	1.036	26.31	1.0625-20	.913	23.19	1.063	27.00	

JAM NUT PANEL CUTOUT

Shell Size	A Flat		B Dia.	
	in. ±.002	mm. ± 0.05	in. ±.005	mm. ± 0.13
5	.423	10.74	.448	11.38
6	.475	12.07	.510	12.95
7	.602	15.29	.635	16.13
8	.602	15.29	.635	16.13
9	.663	16.84	.698	17.73
10	.729	18.82	.760	19.30
12	.851	21.62	.885	22.48
14	.976	24.79	1.010	25.65
15	1.043	26.49	1.073	27.25

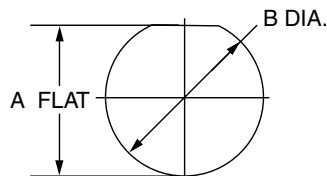

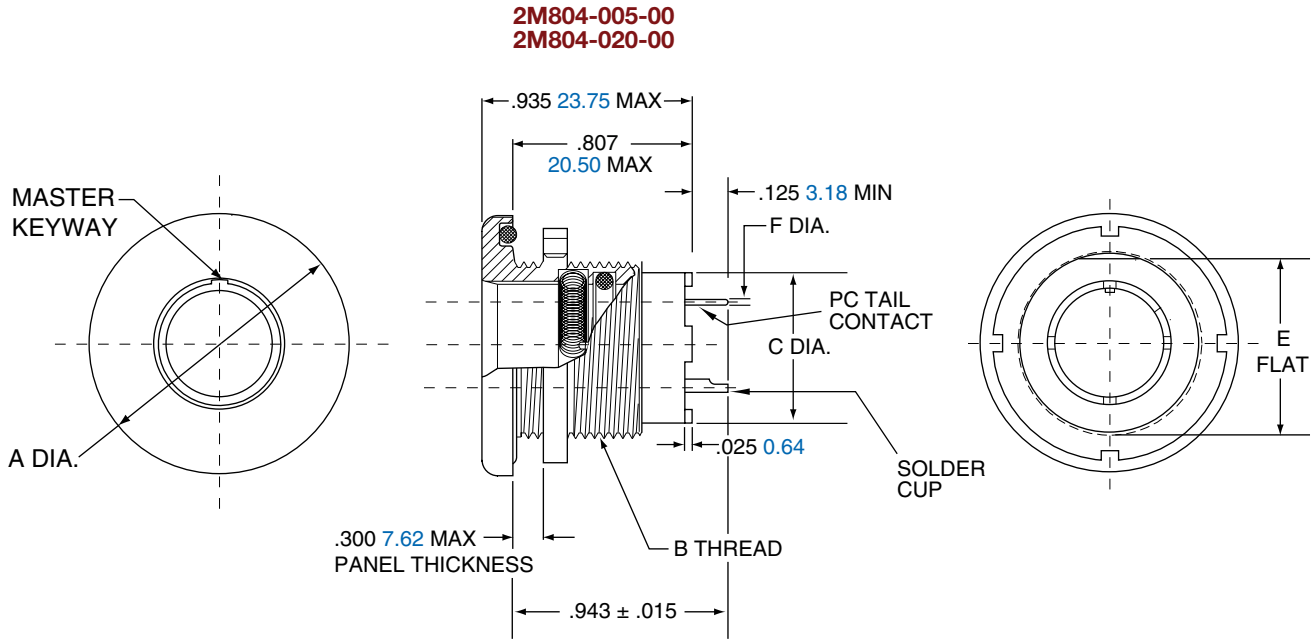

Shell Size	A Dia.		B Thread UN-2A	C Dia.		E Flat.		F Dia. Tail Dia.
	in.	mm.		in.	mm.	in.	mm.	
5	.830	21.08	.5000-32	.274	6.96	.470	11.94	#23 .018/.022 0.46/0.56
6	.884	22.45	.5625-28	.329	8.36	.529	13.44	
7	.994	25.25	.6875-28	.431	10.95	.663	16.84	#20/20HD .025/.027 0.64/0.69
8	.994	25.25	.6875-28	.493	12.52	.663	16.84	
9	1.073	27.25	.7500-28	.551	14.00	.719	18.26	#16 .060/.064 1.52/1.63
10	1.138	28.91	.8125-28	.619	15.72	.778	19.76	
12	1.338	33.99	1.0000-28	.703	17.86	.969	24.61	#12 .092/.096 2.34/2.44
14	1.388	35.26	1.0625-20	.863	21.92	1.019	25.88	
15	1.453	36.91	1.1250-28	.913	23.19	1.113	28.27	

JAM NUT PANEL CUTOUT

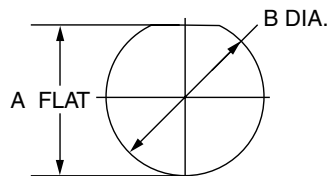

Shell Size	A Flat		B Dia.	
	in. ±.002	mm. ± 0.05	in. ±.005	mm. ± 0.13
5	.477	12.12	.510	12.95
6	.537	13.64	.573	14.55
7	.670	17.02	.698	17.73
8	.670	17.02	.698	17.73
9	.727	18.47	.760	19.30
10	.787	20.00	.823	20.90
12	.977	24.82	1.010	25.65
14	1.027	26.10	1.073	27.75
15	1.121	28.47	1.135	28.83

2M804 Push-Pull Jam Nut Panel Mount Plug



2M804-009-07 and 2M804-021-07

2M804-009-07
2M804-021-07

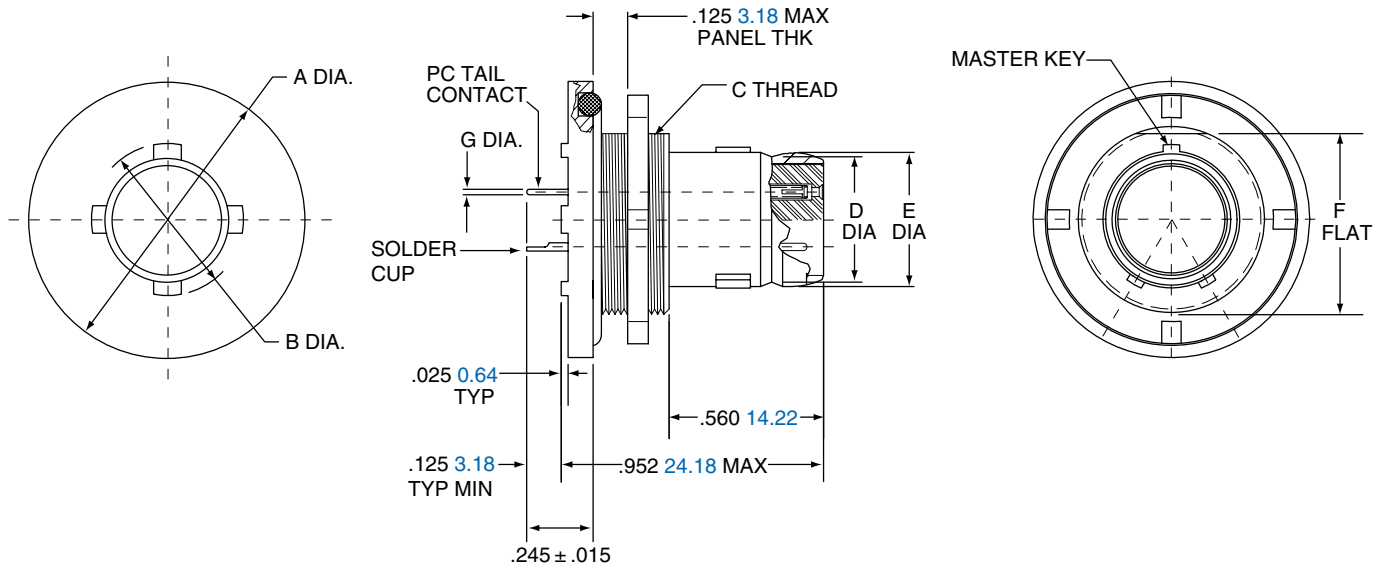

Shell Size	A Dia.		B Dia.		C Thread UN-2A	D Dia.		E Dia.		F Flat.		G PC Tail Dia.
	in.	mm.	in.	mm.		in.	mm.	in.	mm.	in.	mm.	
5	.773	19.63	.244	6.20	.4375-32	.218	5.54	.245	6.22	.414	10.52	#23 .018/.022 0.46/0.56
6	.833	21.16	.330	8.38	.5000-32	.275	6.99	.310	7.87	.468	11.89	#20/20HD .025/.027 0.64/0.69
7	.903	22.94	.432	10.97	.6250-28	.350	8.89	.378	9.60	.593	15.06	#16 .060/.064 1.52/1.63
8	.958	24.33	.493	12.52	.6250-28	.395	10.03	.426	10.82	.593	15.06	#12 .092/.096 2.34/2.44
9	.998	25.35	.551	14.00	.6875-28	.450	11.43	.482	12.24	.653	16.59	
10	1.083	27.51	.620	15.75	.7500-28	.525	13.34	.555	14.10	.721	18.31	
12	1.183	30.05	.703	17.86	.8750-28	.642	16.31	.672	17.07	.843	21.41	
14	1.323	33.60	.863	21.92	1.0000-28	.761	19.33	.795	20.19	.968	24.59	

JAM NUT PANEL CUTOUT

Shell Size	A Flat		B Dia.	
	in. ±.002	mm. ± 0.05	in. ±.005	mm. ± 0.13
5	.423	10.74	.448	11.38
6	.475	12.07	.510	12.95
7	.602	15.29	.635	16.13
8	.602	15.29	.635	16.13
9	.663	16.84	.698	17.73
10	.729	18.82	.760	19.30
12	.851	21.62	.885	22.48
14	.976	24.79	1.010	25.65

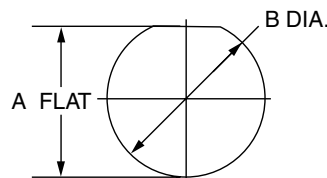

2M804-009-00
2M804-021-00

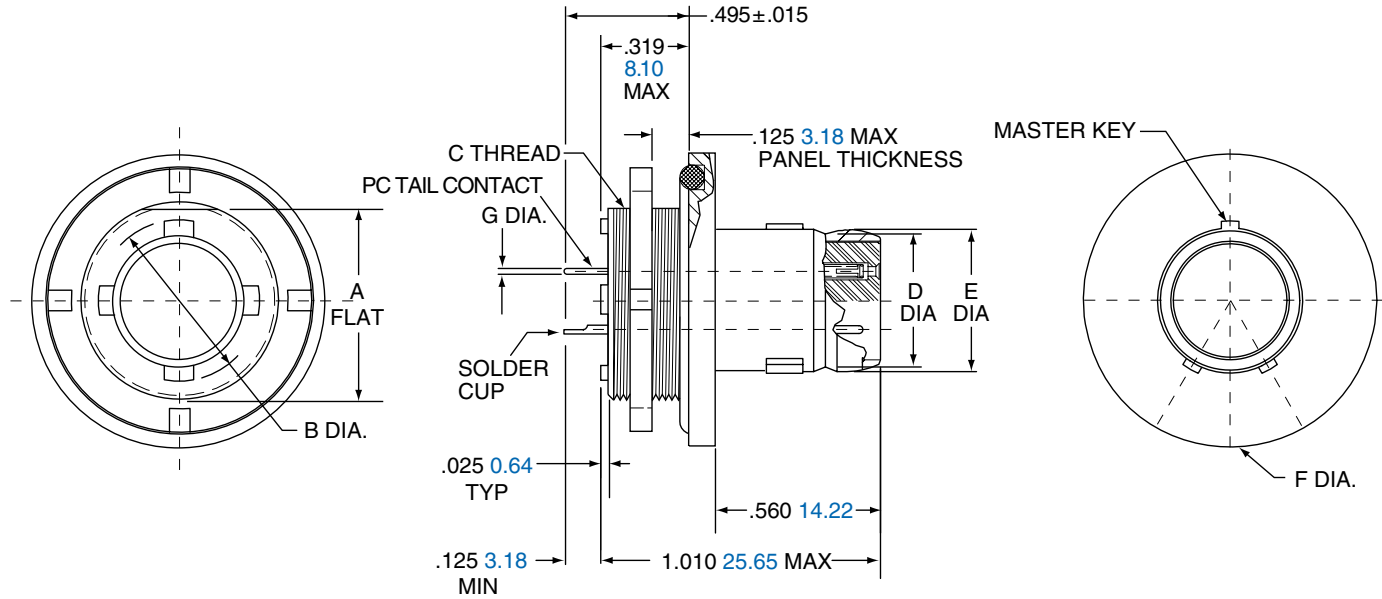

Shell Size	A Flat.		B Dia.		C Thread UN-2A	D Dia.		E Dia.		F Dia.		G PC Tail Dia.
	in.	mm.	in.	mm.		in.	mm.	in.	mm.	in.	mm.	
5	.414	10.52	.244	6.20	.4375-32	.218	5.54	.245	6.22	.773	19.63	#23 .018/.022 0.46/0.56
6	.468	11.89	.330	8.38	.5000-32	.275	6.99	.310	7.87	.833	21.16	#20/20HD .025/.027 0.64/0.69
7	.593	15.06	.432	10.97	.6250-28	.350	8.89	.378	9.60	.903	22.94	#16 .060/.064 1.52/1.63
8	.593	15.06	.493	12.52	.6250-28	.395	10.03	.426	10.82	.958	24.33	#12 .092/.096 2.34/2.44
9	.653	16.59	.551	14.00	.6875-28	.450	11.43	.482	12.24	.998	25.35	
10	.721	18.31	.620	15.75	.7500-28	.525	13.34	.555	14.10	1.083	27.51	
12	.843	21.41	.703	17.86	.8750-28	.642	16.31	.672	17.07	1.183	30.05	
14	.968	24.59	.863	21.92	1.0000-28	.761	19.33	.795	20.19	1.323	33.60	

JAM NUT PANEL CUTOUT

Shell Size	A Flat		B Dia.	
	in. ±.002	mm. ± 0.05	in. ±.005	mm. ± 0.13
5	.423	10.74	.448	11.38
6	.475	12.07	.510	12.95
7	.602	15.29	.635	16.13
8	.602	15.29	.635	16.13
9	.663	16.84	.698	17.73
10	.729	18.82	.760	19.30
12	.851	21.62	.885	22.48
14	.976	24.79	1.010	25.65

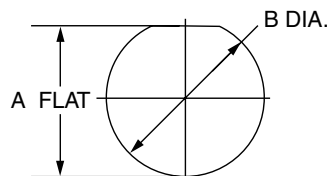

2M804 Push-Pull Flange Panel Mount Plug



2M804-009-02 and 2M804-021-02

2M804-009-02
2M804-021-02

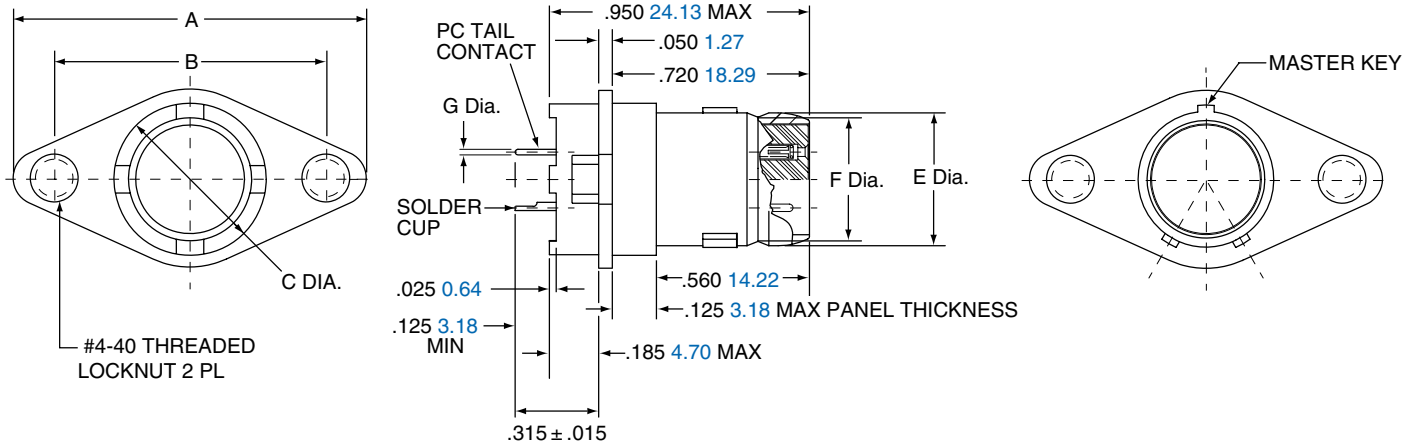

Shell Size	A		B		C Dia.		E Dia.		F Dia.		G PC Tail Dia.
	in.	mm.	in. ± .005	mm. ± 0.13	in.	mm.	in.	mm.	in.	mm.	
5	1.055	26.80	.755	19.18	.323	8.20	.245	6.22	.218	5.54	#23 .018/.022 0.46/0.56
6	1.120	28.45	.820	20.83	.388	9.86	.310	7.87	.275	6.99	#20/20HD .025/.027 0.64/0.69
7	1.185	30.10	.885	22.48	.453	11.51	.378	9.60	.350	8.89	#16 .060/.064 1.52/1.63
8	1.230	31.24	.930	23.62	.498	12.65	.425	10.80	.395	10.03	#12 .092/.096 2.34/2.44
9	1.290	32.77	.990	25.15	.558	14.17	.482	12.24	.450	11.43	
10	1.360	34.54	1.060	26.92	.628	15.95	.555	14.10	.525	13.34	
12	1.485	37.72	1.185	30.10	.753	19.13	.672	17.07	.642	16.31	
14	1.600	40.64	1.300	33.02	.868	22.05	.795	20.19	.761	19.33	

2M804

D

Ordering Guide for 2M667-202

2M804 Push-Pull Protective Caps are available in plug and receptacle versions. Protective caps keep the connector interface dry and clean while not in use. Caps come in a variety of materials, lanyard styles and lengths to accommodate specific design requirements.



1. SERIES	2. SERVICE CLASS	3. SHELL SIZE	4. ATTACHMENT TYPE	5. ATTACHMENT LENGTH IN INCHES	6. ATTACHMENT CODE	7. PULL RING OPTION
2M667-202	-M	9	-G	-5	04	R

1. SERIES	
Part #	Description
2M667-202	Protection Caps 2M804 Receptacles

2. SERVICE CLASS			
Material	Part #	Description	RoHS
Aluminum	-C	Black Anodized (Non-conductive)	
	-M	Electroless Nickel	
	-NF	Olive Drab Cadmium	
	-MT	Durmalon (Ni PTFE)	
	-ZN	Olive Drab Zinc Nickel	
	-ZNU	Black Zinc Nickel	
Stainless Steel	-Z1	Passivated	
	-ZM	Electroless Nickel	

3. SHELL SIZE
5
6
7
8
9
10
12
14

4. ATTACHMENT TYPE		
	Part #	Description
	-G	Nylon Rope
	-H	Stainless Steel Wire Rope, Teflon® Jacket
	-N	No Attachment
	-S	Stainless Steel Sash Chain
	-SK	Nylon Rope With Slip Knot
	-T	Stainless Steel Wire Rope, No Jacket
	-U	Stainless Steel Wire Rope, Polyurethane Jacket

5. ATTACHMENT LENGTH IN INCHES	
-5	Inch Length
Omit for attachment Type N (No Attachment) Example "-5" equals five inch length	

6. ATTACHMENT CODE				
Omit for attachment Types N (No Attachment) and SK (Slip Knot)				
	Small Ring	01 - .126 (3.20) I.D.		
		02 - .145 (3.68) I.D.		
		04 - .188 (4.78) I.D.		
		06 - .197 (5.00) I.D.		
		14 - .385 (9.78) I.D.		
	Large Ring	15 - .445 (11.30) I.D.		
		16 - .570 (14.48) I.D.		
		17 - .635 (16.13) I.D.		
		18 - .695 (17.65) I.D.		
		19 - .885 (22.48) I.D.		
		20 - 1.070 (27.17) I.D.		
		21 - 1.135 (28.83) I.D.		
		25 - 0.820 (20.8) I.D.		
			Split Ring	50 - .420 (10.67) I.D.
				52 - .480 (12.19) I.D.
54 - .635 (16.13) I.D.				
56 - .745 (18.92) I.D.				
58 - .885 (22.48) I.D.				
		60 - 1.010 (25.65) I.D.		
		64 - 1.125 (28.58) I.D.		
		68 - 1.345 (34.16) I.D.		

7. PULL RING OPTION	
R	Supplied with Pull Ring
	Omit for None

2M804 Push-Pull Plug Protection Caps



Ordering Guide for 2M809-198

1. SERIES	2. SERVICE CLASS	3. SHELL SIZE	4. ATTACHMENT TYPE	5. ATTACHMENT LENGTH IN INCHES	6. ATTACHMENT CODE
2M809-198	-M	9	-G	-5	04

1. SERIES	
Part #	Description
2M809-198	Protection Caps 2M804 Plug

2. SERVICE CLASS			
Material	Part #	Description	RoHS
Aluminum	-C	Black Anodized (Non-conductive)	
	-M	Electroless Nickel	
	-NF	Olive Drab Cadmium	
	-MT	Durmalon (Ni PTFE)	
	-ZN	Olive Drab Zinc Nickel	
	-ZNU	Black Zinc Nickel	
Stainless Steel	-Z1	Passivated	
	-ZM	Electroless Nickel	

3. SHELL SIZE
5
6
7
8
9
10
12
14

4. ATTACHMENT TYPE		
Part #	Description	
-G	Nylon Rope	
-H	Stainless Steel Wire Rope, Teflon® Jacket	
-N	No Attachment	
-S	Stainless Steel Sash Chain	
-SK	Nylon Rope With Slip Knot	
-T	Stainless Steel Wire Rope, No Jacket	
-U	Stainless Steel Wire Rope, Polyurethane Jacket	

5. ATTACHMENT LENGTH IN INCHES	
-5	Inch Length
Omit for attachment Type N (No Attachment) Example "-5" equals five inch length	

6. ATTACHMENT CODE	
Omit for attachment Types N (No Attachment) and SK (Slip Knot)	
Small Ring	01 -.126 (3.20) I.D.
	02 -.145 (3.68) I.D.
	04 -.188 (4.78) I.D.
	06 -.197 (5.00) I.D.
Large Ring	14 -.385 (9.78) I.D.
	15 -.445 (11.30) I.D.
	16 -.570 (14.48) I.D.
	17 -.635 (16.13) I.D.
	18 -.695 (17.65) I.D.
	19 -.885 (22.48) I.D.
Split Ring	20 -1.070 (27.17) I.D.
	21 -1.135 (28.83) I.D.
	25 -0.820 (20.8) I.D.
	50 -.420 (10.67) I.D.
	52 -.480 (12.19) I.D.
	54 -.635 (16.13) I.D.
	56 -.745 (18.92) I.D.
	58 -.885 (22.48) I.D.
60 -1.010 (25.65) I.D.	
64 -1.125 (28.58) I.D.	
68 -1.345 (34.16) I.D.	

2M809-198

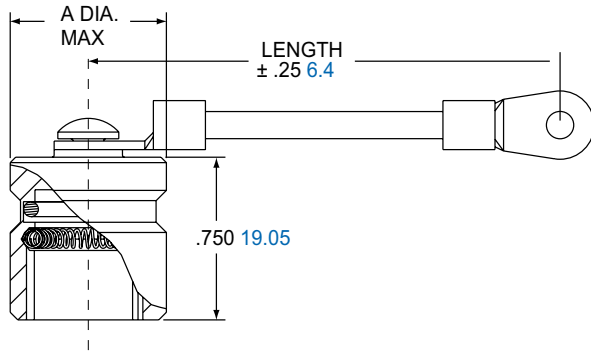

2M667-202

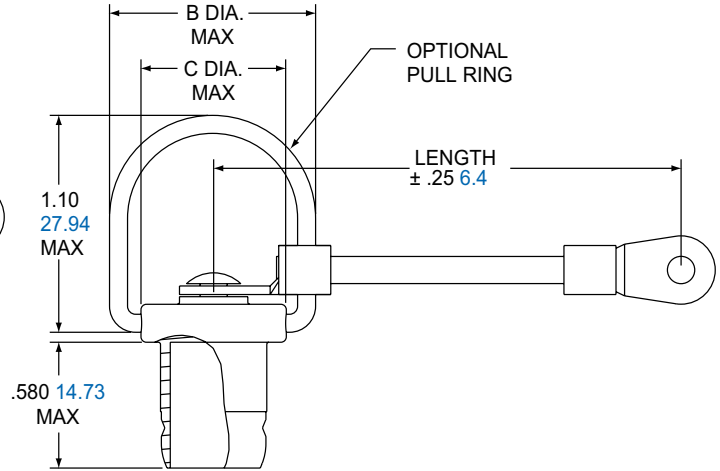

Shell Size	A Max.		B Max.		C Max.	
	in.	mm.	in.	mm.	in.	mm.
5	.483	12.27	.720	18.29	.498	12.65
6	.533	13.54	.720	18.29	.503	12.78
7	.633	16.08	.800	20.32	.578	14.68
8	.658	16.71	.850	21.59	.627	15.93
9	.708	17.98	.900	22.86	.678	17.22
10	.783	19.89	1.010	25.65	.791	20.09
12	.908	23.06	1.090	27.69	.868	22.05
14	1.033	26.24	1.210	30.73	.988	25.10
15	1.083	27.51	1.260	32.00	1.038	26.37

MATERIALS AND FINISHES

Cover	Aluminum alloy or stainless steel
O-Ring	Fluorosilicone rubber
Wire, Hardware	Stainless steel, passivated

2M804 Push-Pull Plug Rubber Caps



Ordering Guide for 2M809-083 and 2M809-087

Push-Pull Rubber Protective Caps can be used on the 2M804 push-pull plugs and receptacles. These molded rubber covers are ideal for a protective splash-proof option.







1. SERIES	2. SHELL SIZE	3. ATTACHMENT TYPE	4. LANYARD LENGTH	5. ATTACHMENT CODE	6. CONDUCTIVE RUBBER
2M809-083	-6	G	5	-04	C

1. SERIES	
Part #	Description
2M809-083	Protection Caps 2M804 Plug
2M809-087	Protection Caps 2M804 Receptacles

2. SHELL SIZE		3. ATTACHMENT TYPE	
-5		G	Nylon Rope
-6		N	No Attachment
-7			
-8			
-9			
-10			
-12			
-14			

4. LANYARD LENGTH	
5	Inch length
Example "-5" equals five inch length	

5. ATTACHMENT CODE	
	-WS Nylon Cable tie, 1.77 Inch (45mm) Maximum Wire Bundle Diameter
	-SK Slip Knot
	-00 Lanyard with no attachment (fused End)
	-01 -.147 (3.73) I.D.
	-02 -.147 (3.73) I.D.
	-04 -.173 (3.94) I.D.
	-06 N/A
	-07 -.385 (9.78) I.D.
	-08 -.510 (13.11) I.D.
	-09 -.583 (14.81) I.D.
	-10 -.766 (19.4) I.D.
	-11 -.896 (25.76) I.D.
	-12 -1.015 (25.78) I.D.
	-15 -.445 (11.30) I.D.
	-16 -.570 (14.48) I.D.
	-17 -.635 (16.13) I.D.
	-18 -.695 (17.65) I.D.
	-19 -.885 (22.48) I.D.
	-20 -1.070 (27.18) I.D.
	-21 -1.135 (28.83) I.D.
-25 -0.820 (20.8) I.D.	

6. CONDUCTIVE RUBBER	
Omit for Standard Neoprene	
C	Conductive Rubber

2M804

D

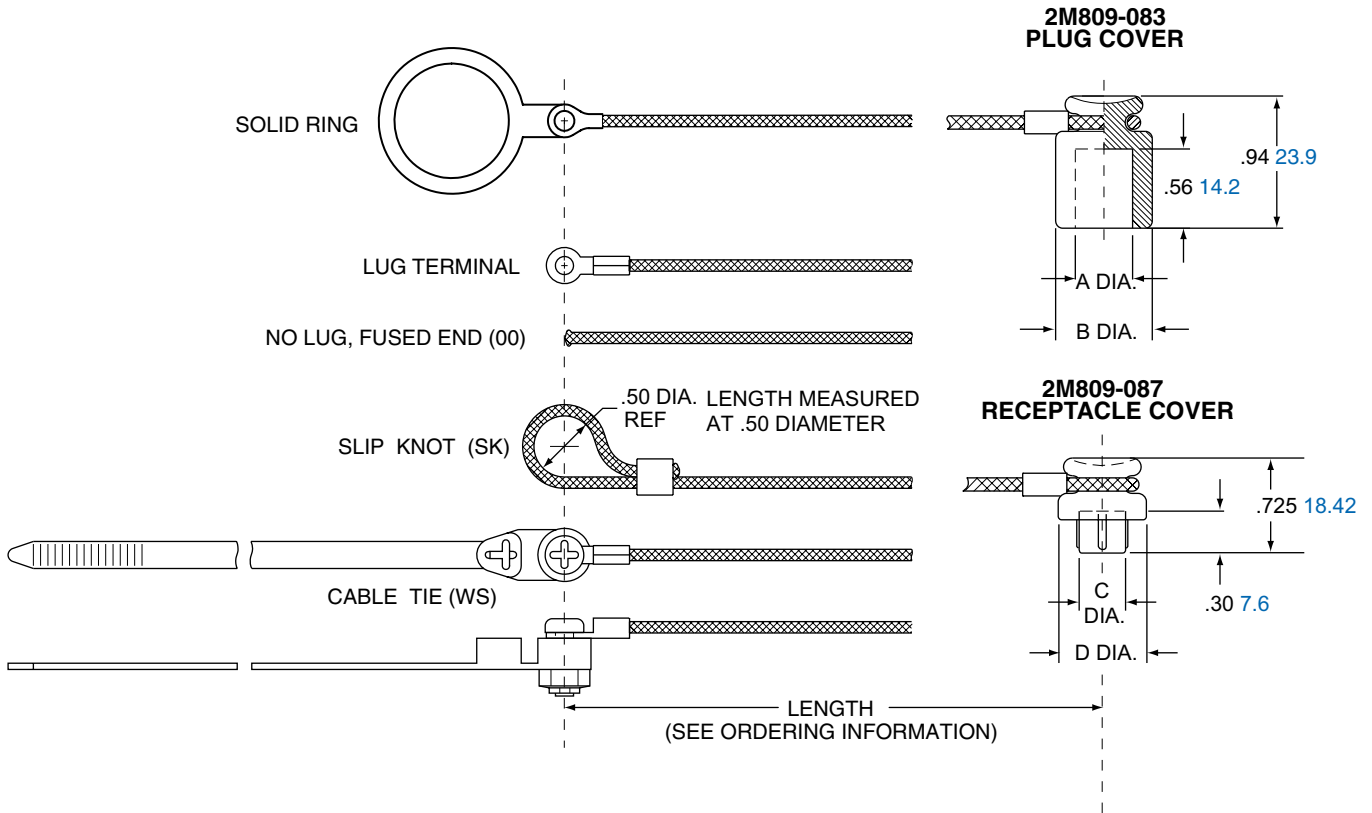

Shell Size	A Dia.		B Dia.		C Dia.		D Dia.	
	in.	mm.	in. ± .005	mm. ± 0.13	in.	mm.	in.	mm.
5	.230	5.84	.560	14.22	.293	7.44	.638	16.21
6	.290	7.37	.560	14.22	.358	9.09	.700	17.78
7	.360	9.14	.560	14.22	.418	10.62	.825	20.96
8	.410	10.41	.680	17.27	.473	12.01	.825	20.96
9	.460	11.68	.680	17.27	.526	13.36	.888	22.56
10	.540	13.72	.790	20.07	.603	15.32	.950	24.13
12	.650	16.51	.790	20.07	.724	18.39	1.075	27.31
14	.780	19.81	1.110	28.19	.845	21.46	1.200	30.48
15	.845	21.46	1.110	28.19	.900	22.86	1.325	33.66

MATERIALS	
Cover	Neoprene rubber blend, black
Lanyard	.062" (1.57) diameter nylon cord, black
Cable Tie	6/6 nylon, black SST locking tab
Ring	Stainless steel

Low Profile EMI/RFI Plug and Backshell Combo

OVERVIEW

2M Python is a low profile EMI/RFI plug and backshell combo. This innovative combination reduces space requirements without compromising on ruggedness or shielding performance. Available in 2M 801 Series, 804 Series, and 805 Series, Python assemblies provide superior low profile cable routing and 2M Micro38999 connector performance all-in-one.

BENEFITS:

SPACE SAVINGS

- This plug and backshell combo design saves space, with a minimum height and superior EMI performance.

EASY MAINTENANCE

- The rear removable cover makes it easy to cut wires and remove contacts for easy maintenance.

SIMPLE ASSEMBLY

- Assembles with crimp or solder cup size 23 contacts.
- Multiple cable entry options available for each connector size (rear opening).

KEY ROTATIONS

- All key rotations are available as well as several connector clockings (rotating main key).

