

E33711

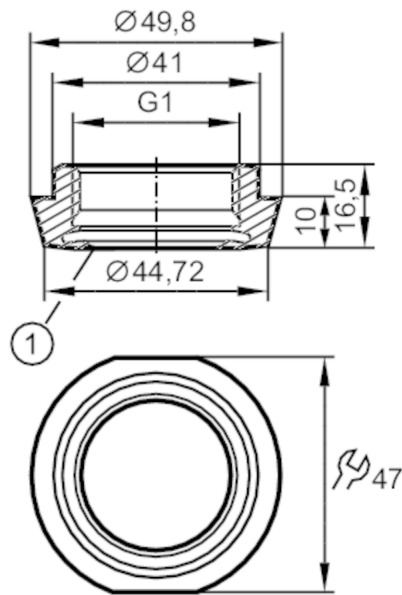

Process adapter hygienic pipe fitting

ADAPT IFM-DIN11851 DN32/1.25"



1 sealing edge

EC 1935/2004 FCM 

Application

Pressure rating [bar] 40

Tests / approvals

Pressure Equipment Directive	A possible classification to PED depends on the application and has to be carried out by the user / operator.
Safety instructions	The compatibility between medium and product material has to be checked in all applications.

Mechanical data

Weight [g]	136
Materials	stainless steel (1.4435 / 316L)
Sensor connection	G 1 external thread Aseptoflex Vario
Process connection	hygienic pipe fitting DN32 (1,25") DIN 11851
Surface characteristics Ra/Rz of the wetted parts	0.4 / 4
Sealing	metal to metal
Hygienic equipment class to DIN 11866	H4

Remarks

Pack quantity 1 pcs.