

M12 male 0° / M12 female 0°

PVC 5x0.34 bk UL/CSA 20m

Male straight to female straight

M12 - M12, 5-pole

Art.-No. 7005 - M12 Lite - (plastic hexagonal screw) on request

Plastic housings with good resistance against chemicals and oils. The resistance to aggressive media should be individually tested for your application. Further details on request. Further cable lengths on request.

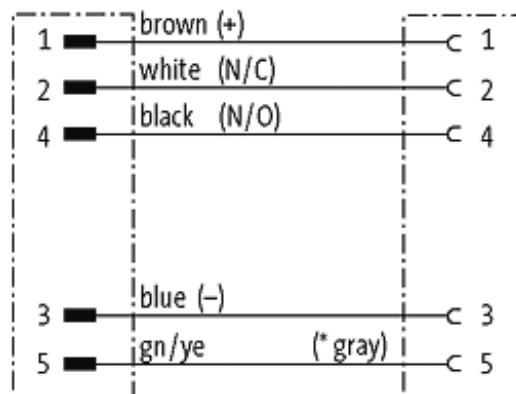
[Link to Product](#)**Illustration**

(* for cable type 126 and 732)

Male

Female



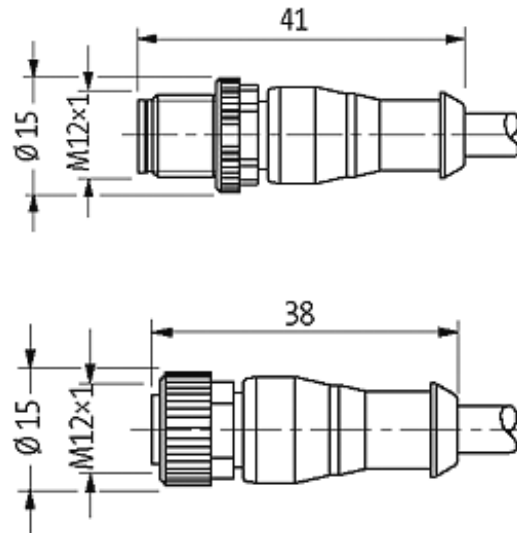

Product may differ from Image