

## 3G GSM & GPS Combo Antenna

### Features

- GPS & GSM Antenna
- Screw and Adhesive Fixing
- Operates from -40 to +85°C

### GPS Antenna

- 1575.42MHz +/- 1MHz
- Gain: 0dBic (Zenith)
- Noise <1.5
- 3metres RG174 Cable
- SMA Male Connector
- V.S.W.R <1.5

### GSM Antenna

- 824-960/ 1710-2170MHz
- Gain: 2dBi (Zenith)
- V.S.W.R <2.5
- Linear polarisation
- Impedence 50ohm

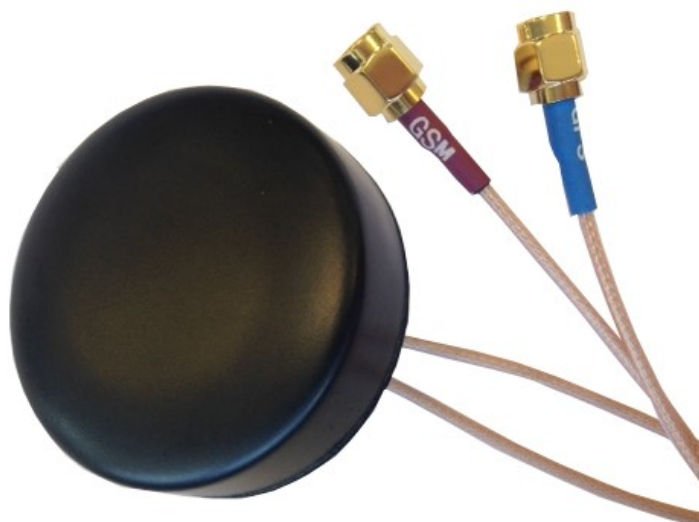

### Applications

- Car GPS Systems
- Hand held GPS Systems
- GSM modems

### Description

A compact Antenna for GPS applications where high performance is required from a small size. The antenna includes a Low Noise Amplifier and incorporates is housed in a rugged low profile UV resistant, this antenna is compact and resistant to Vandalism.

### Ordering Information

Part Number	Description	Cable Length	Connector
ANT-GSMGPS-SMA	Combo GSM & GPS Ant Adhesive mount	3metres	SMA (M)

## GSM Antenna Radiation Patterns

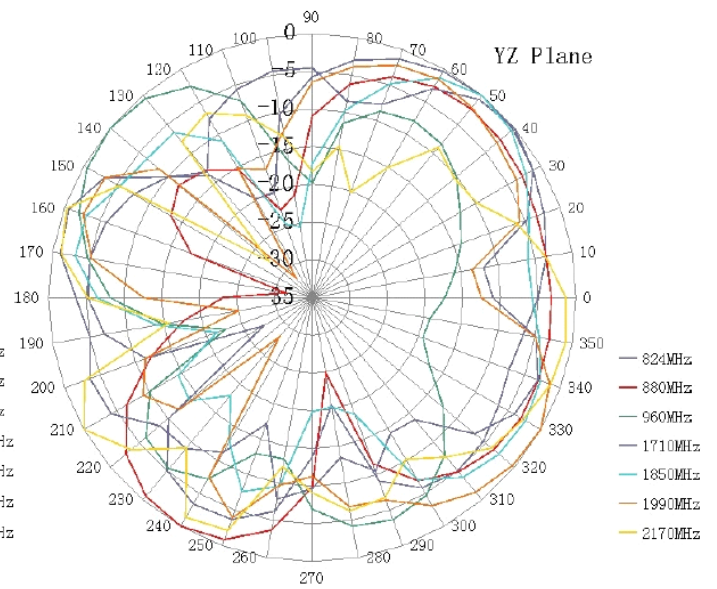
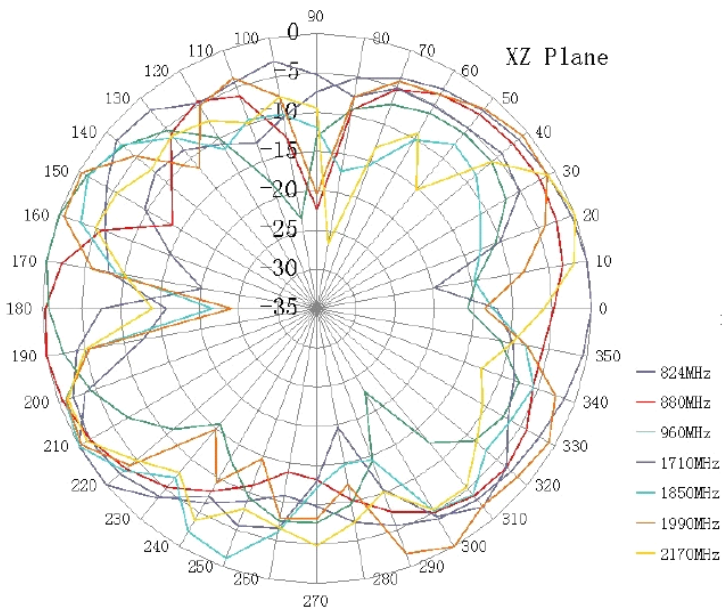
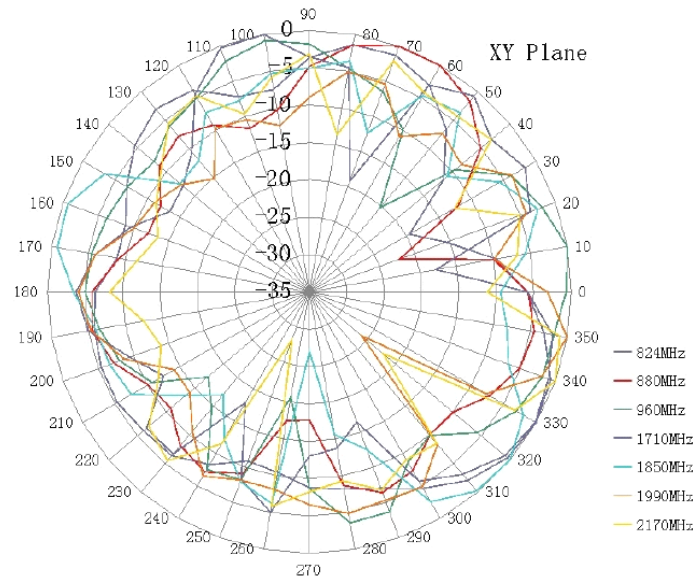

## GPS Antenna Radiation Patterns

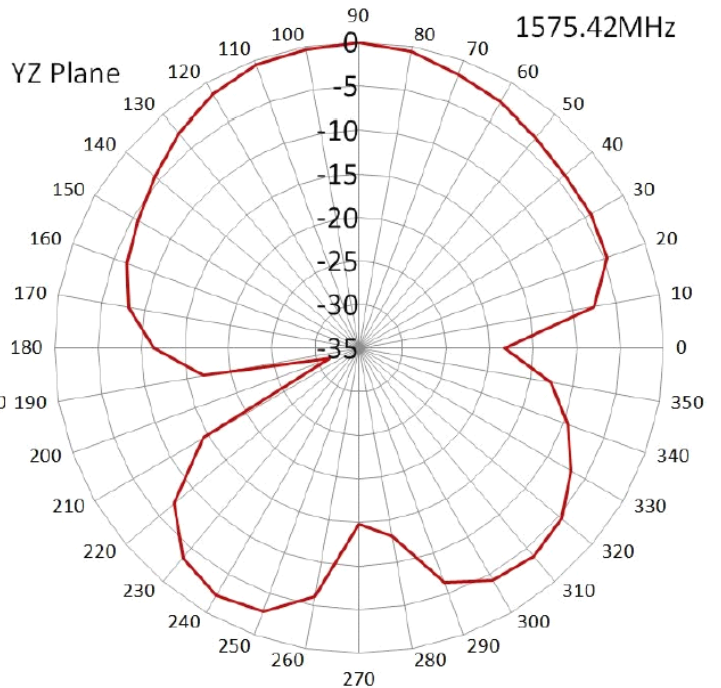
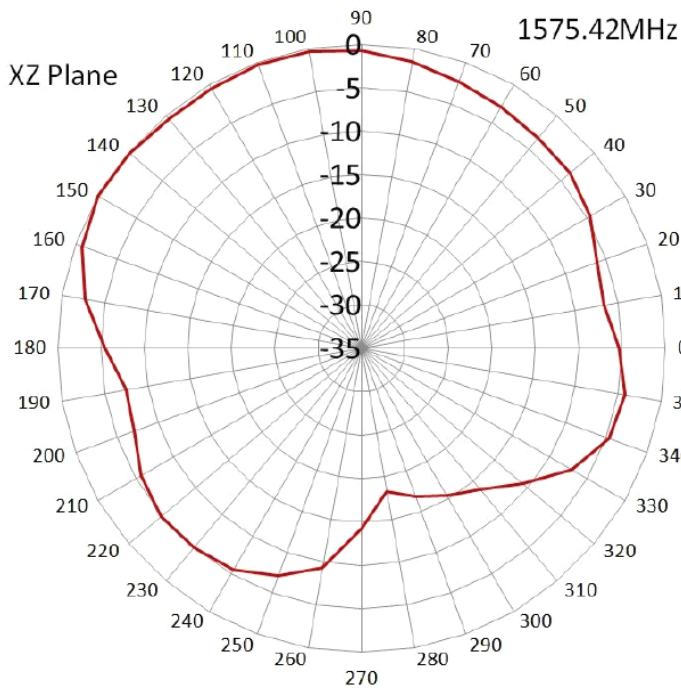
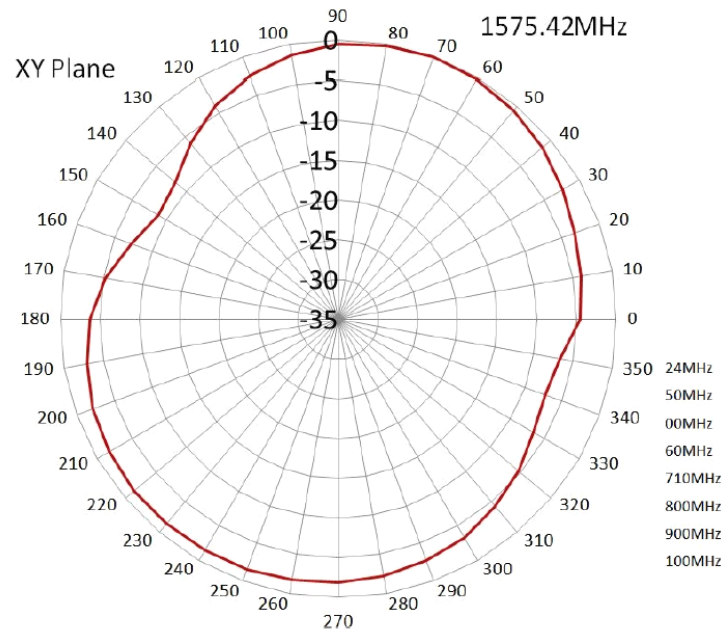

# GSM GPS Antenna



## Technical diagram

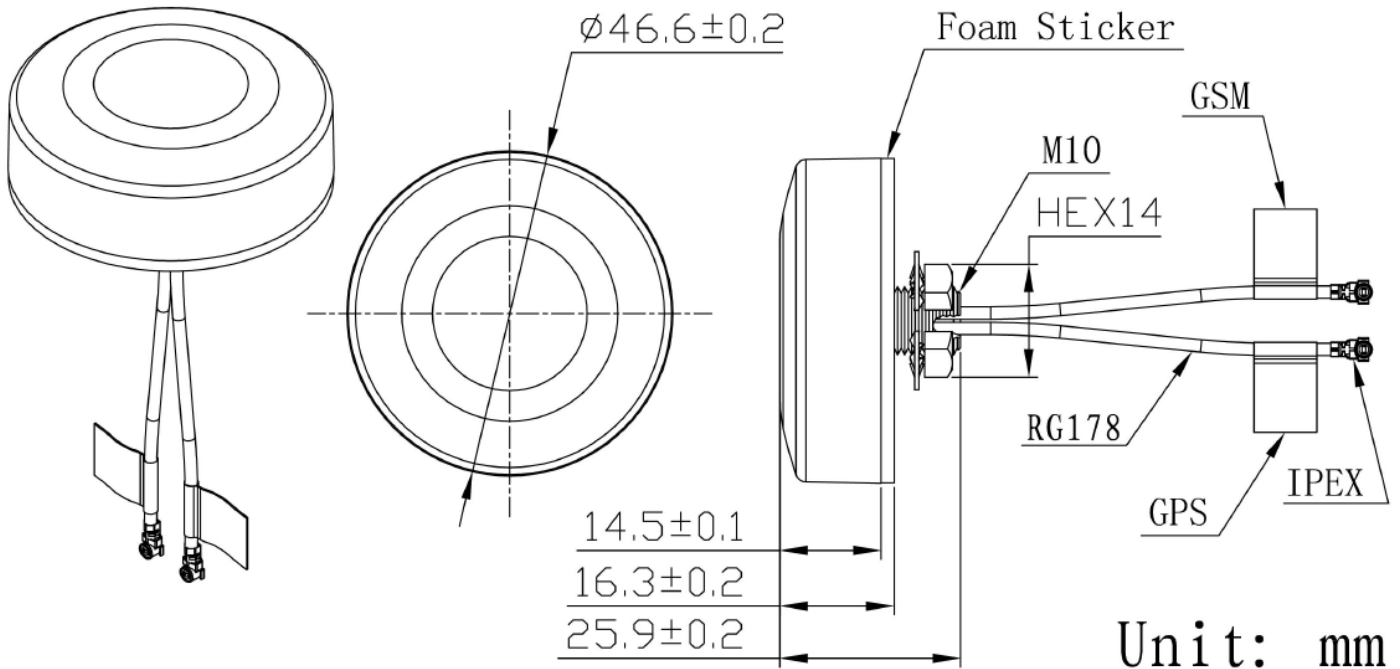

### RF Solutions Ltd. Recycling Notice Meets the following EC Directives:

#### DO NOT

Discard with normal waste, please recycle.

#### ROHS Directive 2002/95/EC

Specifies certain limits for hazardous substances.

#### WEEE Directive 2002/96/EC

Waste electrical & electronic equipment. This product must be disposed of through a licensed WEEE collection point. RF Solutions Ltd., fulfills its WEEE obligations by membership of an approved compliance scheme.

### Waste Batteries and Accumulators Directive 2006/66/EC

Where batteries are fitted, before recycling the product, the batteries must be removed and disposed of at a licensed collection point.

Environment Agency producer registration number: WEE/JB0104WV.

#### Disclaimer:

Whilst the information in this document is believed to be correct at the time of issue, RF Solutions Ltd does not accept any liability whatsoever for its accuracy, adequacy or completeness. No express or implied warranty or representation is given relating to the information contained in this document. RF Solutions Ltd reserves the right to make changes and improvements to the product(s) described herein without notice. Buyers and other users should determine for themselves the suitability of any such information or products for their own particular requirements or specification(s). RF Solutions Ltd shall not be liable for any loss or damage caused as a result of user's own determination of how to deploy or use RF Solutions Ltd's products. Use of RF Solutions Ltd products or components in life support and/or safety applications is not authorised except with express written approval. No licences are created, implicitly or otherwise, under any of RF Solutions Ltd's intellectual property rights. Liability for loss or damage resulting or caused by reliance on the information contained herein or from the use of the product (including liability resulting from negligence or where RF Solutions Ltd was aware of the possibility of such loss or damage arising) is excluded. This will not operate to limit or restrict RF Solutions Ltd's liability for death or personal injury resulting from its negligence.