

Grub Screws with Star Grip • similar to DIN 6336, stainless steel A4

24741.0110



Product Description

Ces Boutons étoiles sont fabriquées selon la norme DIN 6336, mais il s'agit d'une version sans cavité, évitant la rétention d'impuretés. Ces Boutons étoiles conviennent donc à tous les domaines d'application où les exigences en matière d'hygiène sont élevées. The stainless steel A4 version ensures maximum corrosion resistance.

Material

Handle

- Stainless steel 1.4408, precision casting, polished

Screw

- Stainless steel A4

Drawing

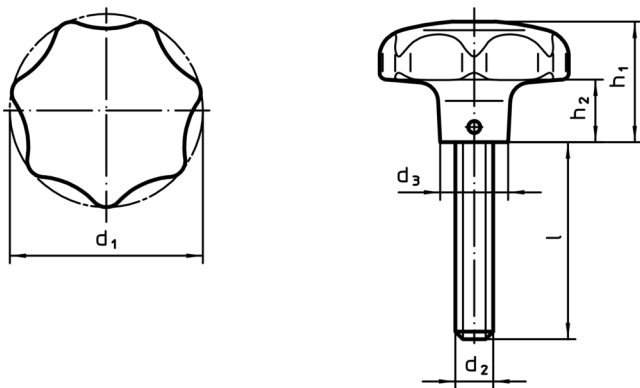

Order information

Dimensions						[g]	Art. No.
d ₁	d ₂	l	d ₃	h ₁	h ₂		
40	M8	25	14	25	12	115	24741.0110

Compliance

RoHS compliant

Compliant according to Directive 2011/65/EU and Directive 2015/863

Does not contain SVHC substances

No SVHC substances with more than 0.1% w/w contained - SVHC list [REACH] as of 10.06.2022

Does not contain Proposition 65 substances

No Proposition 65 substances included
<https://www.P65Warnings.ca.gov/>

Free from Conflict Minerals

This product does not contain any substances designated as "conflict minerals" such as tantalum, tin, gold or tungsten from the Democratic Republic of Congo or adjacent countries.