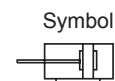

**Serie »ACP«**

13.DM.12005–13.DM.100100

**Produktbeschreibung**

Besonders kurz bauende und platzsparende Ausführung.

**Technische Daten**

Kolben-Ø [mm]	12	16	20	25	32	40	50	63	80	100
Wirkprinzip	Doppeltwirkend									
Medium	Gefilterte und ungeölte oder geölte Druckluft. (Filtration mit 40 µm Filter notwendig). Bei Verwendung von geölter Druckluft auf kontinuierliche Ölung achten.									
Arbeitsdruck	1–10 bar (0,1 bis 1,0 MPa; 14 bis 145 psi)									
Prüfdruck	15 bar (1,5 MPa; 215 psi)									
Temperaturbereich	-20 bis 70 °C									
Geschwindigkeitsbereich	30–500 mm/s									
Dämpfungstyp	Dämpfungsring									
Anschlussgröße	M5x0,8					1/8"				1/4"

**Kolbenhub, doppeltwirkend**

Kolben-Ø	Standardhub	Max. Kolbenhub	Verfügbare Kolbenhub
12 16	5 / 10 / 15 / 20 / 25 / 30 / 35 / 40 / 45 / 50 / 55 / 60	60	200
20 25	5 / 10 / 15 / 20 / 25 / 30 / 35 / 40 / 45 / 50 / 55 / 60 / 65 / 70 / 75 / 80	80	200
32 40 50 63	5 / 10 / 15 / 20 / 25 / 30 / 35 / 40 / 45 / 50 / 55 / 60 / 65 / 70 / 75 / 80 / 85 / 90 / 95 / 100	100	300
80 100	5 / 10 / 15 / 20 / 25 / 30 / 35 / 40 / 45 / 50 / 55 / 60 / 65 / 70 / 75 / 80 / 85 / 90 / 95 / 100	100	400

(Werte in mm)

**Bestellinformationen**

Artikel Nr.	Kolben-Ø	Hub	Anschluss	Kolbenstangeninnengewinde
13.DM.12005–12060	12	5–60	M5x0,8	M3x0,5
13.DM.16005–16060	16	5–60	M5x0,8	M4x0,7
13.DM.20005–20080	20	5–80	M5x0,8	M5x0,8
13.DM.25005–25080	25	5–80	M5x0,8	M5x0,8
13.DM.32005–32100	32	5–100	G 1/8	M6x1,0
13.DM.40005–40100	40	5–100	G 1/8	M6x1,0
13.DM.50005–50100	50	5–100	G 1/8	M8x1,25
13.DM.63005–63100	63	5–100	G 1/8	M8x1,25
13.DM.80005–80100	80	5–100	G 1/8	M10x1,5
13.DM.100005–100100	100	5–100	G 1/4	M12x1,75

(Werte in mm)

Serie »ACP«

13.DM.12005–13.DM.100100

Maße

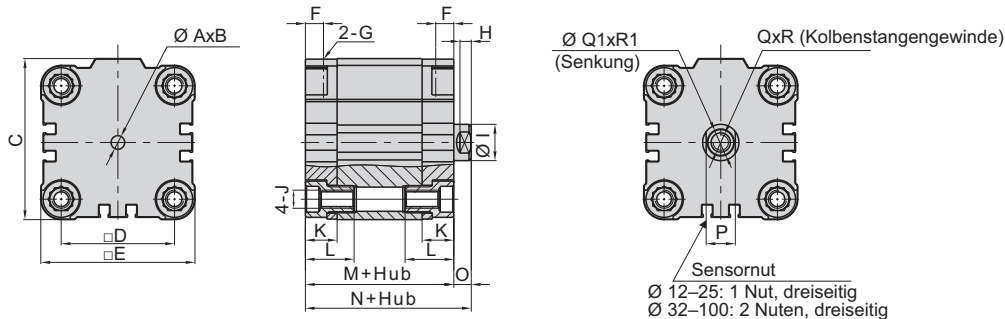

Kolben-Ø	A	B	C	D	E	F	G	H	I	J	K	L	M	N	O	P	Q	Q1	R	R1
12	6	4	30	18	29	7	M5x0,8	3	6	M4x0,7	11,5	18	38	42,5	4,5	5	M3x0,5	3,3	8	1,5
16	6	4	30	18	29	7	M5x0,8	3	8	M4x0,7	11,5	18	38	42,5	4,5	6	M4x0,7	4,5	10	1,5
20	6	4	37,5	22	36	7	M5x0,8	3	10	M5x0,8	11,5	18	38	42,5	4,5	8	M5x0,8	5,5	12	2
25	6,1	4	41,5	26	40	7	M5x0,8	4	10	M5x0,8	11,5	18	39,5	45	5,5	8	M5x0,8	5,5	12	2
32	6,1	4	52	32	50	8	1/8"¹)	4,5	12	M6x1,0	14	21	44,5	50,5	6	10	M6x1,0	6,5	14	2,6
40	6,1	4	62,5	42	60	8	1/8"¹)	4,5	12	M6x1,0	14	21	45,5	52	6,5	10	M6x1,0	6,5	14	2,6
50	6,1	4	71	50	68	8	1/8"¹)	5	16	M8x1,25	14	21,5	45,5	53	7,5	13	M8x1,25	8,5	16	3,3
63	8,1	4	91	62	87	8	1/8"¹)	5	16	M10x1,5	15	24	50	57,5	7,5	13	M8x1,25	8,5	16	3,3
80	8,1	4	111	82	107	8,5	1/8"¹)	5,5	20	M10x1,5	16	27	56	64	8	17	M10x1,5	10,5	20	4,7
100	8,1	4	133	103	128	10,5	1/4"¹)	7,5	25	M10x1,5	19	32	66,5	76,5	10	22	M12x1,75	12,5	24	6,1

(Werte in mm, Ausnahme ¹) = Zoll)

Komponenten und Material

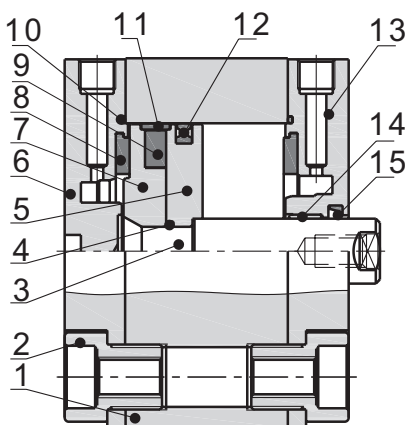

Nr.	Bauteil	Material			
		12¹)	25¹)	16–32¹)	40–100¹)
1	Gehäuse	Aluminiumlegierung			
2	Schraube	Stahl			
3	Kolbenstange	Edelstahl		Stahl	
4	O-Ring	NBR			
5	Kolben	Aluminiumlegierung			
6	Zylinderdeckel / Fußseite	Aluminiumlegierung			
7	Magnethalter	Aluminiumlegierung			
8	Dämpfungsring	TPU			
9	Magnet	Sintermetall			Kunststoff
10	O-Ring	NBR			
11	Verschleißring	-			Verschleißfestes Material
12	Kolben O-Ring	NBR			
13	Zylinderdeckel / Kopfseite	Aluminiumlegierung			
14	Führungsbuchse	12–20: -			
		25–100: Verschleißfestes Material (Bronzelegierung)			
15	Kolbenstangen-dichtung	NBR			

## Zubehör

**Schwenkaugenbefestigung, Typ »CA/CB«  
437.420–437.429**

\*\*\* Bei diesen Artikeln handelt es sich um Auslaufartikel.  
Lieferung solange Vorrat reicht.



Ø 12–25

Ø 32–100

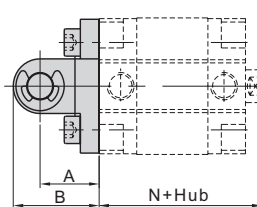
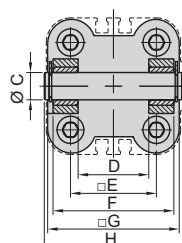
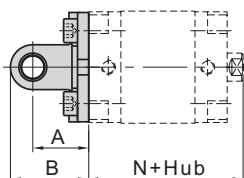
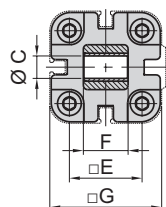

**Maße und Material (Typ CA = Kolben-Ø 12-25; Typ CB = Kolben-Ø 32-100)**

Artikel Nr.	Kolben-Ø	A	B	C	D	E	F	G	H	N	Material
437.420***	12	16	22	6	-	18	12	27,5	-	42,5	Aluminium- legierung
	16										
437.422***	20	20	28	8	-	22	16	34,5	-	42,5	
437.423***	25	20	28	8	-	26	16	38,5	-	45	
437.424***	32	22	32	10	26	32	45	48	51,5	50,5	
437.425***	40	25	37	12	28	42	52	58	59	52	
437.426***	50	27	39	12	32	50	60	66	67	53	
437.427***	63	32	48	16	40	62	70	85	77	57,5	
437.428***	80	36	52	16	50	82	90	105	97	64	
437.429***	100	41	61	20	60	103	110	126	119	76,5	

(Werte in mm)

**Fußbefestigung, Typ »LB«  
437.400–437.409**

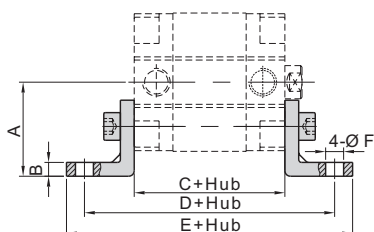
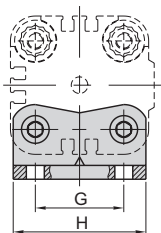
\*\*\* Bei diesen Artikeln handelt es sich um Auslaufartikel.  
Lieferung solange Vorrat reicht.

**Maße und Material**

Artikel Nr.	Kolben-Ø	A	B	C	D	E	F	G	H	Material
437.400	12	22	3	38	64	73,6	5,5	18	27	Stahl
	16									
437.402	20	27	3,8	38	70	82,6	6,5	22	34	
437.403	25	29	3,8	39,5	71,5	84	6,5	26	38	
437.404***	32	34	4,8	44,5	80,5	97,1	6,5	32	48	
437.405***	40	40,5	4,8	45,5	85,5	102,1	9	42	58	
437.406***	50	47	5,8	45,5	93,5	110,1	9	50	66	
437.407***	63	56,5	5,8	50	104	127,6	11	62	85	
437.408***	80	68,5	7,5	56	116	139,6	11	82	105	
437.409***	100	81	7,5	66,5	132,5	156,1	13,5	103	126	

(Werte in mm)

## Zubehör

### Flanschbefestigung, Typ »FA« 437.410–437.419

\*\*\* Bei diesen Artikeln handelt es sich um Auslaufartikel.  
Lieferung solange Vorrat reicht.



Ø 12–25

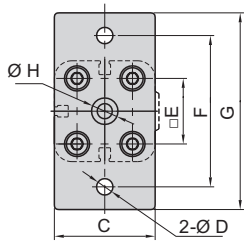

Ø 32–100

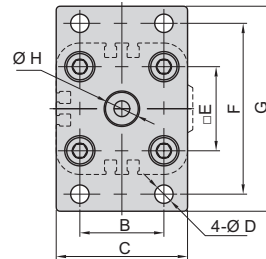

#### Maße und Material

Artikel Nr.	Kolben-Ø	A	B	C	D	E	F	G	H	N	Material
437.41***	12	10	-	30	5,5	18	43	55	14	42,5	Aluminium- legierung
	16										
437.412***	20	10	-	36	6,5	22	55	68	16	42,5	
437.413***	25	10	-	40	6,5	26	60	78	16	45	
437.414***	32	10	32	50	7	32	65	78	18	50,5	
437.415***	40	10	36	60	9	42	82	102	18	52	
437.416***	50	12	45	68	9	50	90	110	22	53	
437.417***	63	15	50	87	9	62	110	128	22	57,5	
437.418***	80	15	63	107	12	82	135	160	28	64	
437.419***	100	15	75	128	14	103	163	190	34	76,5	

(Werte in mm)

## Zubehör

### Gabelkopf, Typ »Y« inkl. Gewintheadapter 438.03D12CP–438.12D100CP

Ø 12–25

Ø 32–100

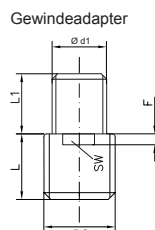
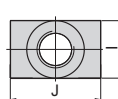
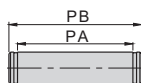
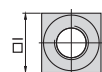
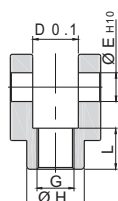
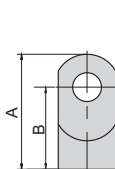
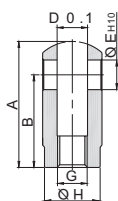

#### Maße und Material

Artikel Nr.	Kolben-Ø	A	B	D	E	F	G	H
438.03D12CP	12	22	16	5,3	5	-	M5x0,8	9
438.04D16CP	16	28	21	6,6	5	-	M6x1,0	11
438.05D20CP	20	34	25	8,3	8	3,5	M8x1,25	15
438.05D25CP	25	41	30	10,3	10	4	M10x1,25	19
438.06D40CP	32/40	42	30	18,4	10	4	M14x1,5	22
438.08D63CP	50/63	64	50	20,2	14	4	M18x1,5	28
438.10D80CP	80	71	50	28,4	18	4,5	M22x1,5	38
438.12D100CP	100	79	55	32,4	22	5	M26x1,5	44

(Werte in mm)

Artikel Nr.	I	J	PA	PB	d1	L	L1	SW	Material
438.03D12CP	10	-	10,2	14,6	M3x0,5	6	5	-	Stahl
438.04D16CP	12	-	12,2	16,6	M4x0,7	11	7	-	
438.05D20CP	16	-	16,2	21	M5x0,8	8,5	6	6	
438.05D25CP	20	-	20,2	26,4	M5x0,8	10,5	6	8	
438.06D40CP	22	36	36,2	42,4	M6x1,0	16	12	12	Eisenguss
438.08D63CP	28	39,8	44,2	50,4	M8x1,25	20	13	16	
438.10D80CP	38	56	56,2	63,6	M10x1,5	23	15	20	
438.12D100CP	44	64	64,2	72,6	M12x1,75	24	22	24	

(Werte in mm)

## Zubehör

### Gelenkauge, Typ »UNIT« inkl. Gewindeadapter 437.03D12CP–437.12D100CP

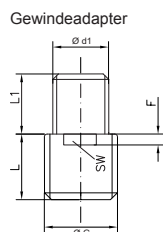
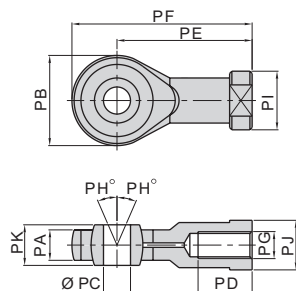

#### Maße und Material

Artikel Nr.	Kolben-Ø	PA	PB	PC(H9)	PD	PE	PF	PG	PH
437.03D12CP	12	6,8	20	6	12	30	40	M6x1,0	13
437.04D16CP	16	9	24	8	16	36	48	M8x1,25	13
437.05D25CP	20/25	11	26	10	20	43	56	M10x1,25	13
437.06D40CP	32/40	11	26	10	20	43	56	M10x1,25	13
437.08D63CP	50/63	12	32	12	22	50	66	M12x1,25	13
437.10D80CP	80	15	40	16	28	64	84	M16x1,5	15
437.12D100CP	100	18	46	20	33	77	100	M20x1,5	15

(Werte in mm)

Artikel Nr.	PI	PJ	PK	d1	L	L1	F	SW	Material
437.03D12CP	13	11	9	M3x0,5	12	8	-	-	Stahl
437.04D16CP	16	14	12	M4x0,7	16	10	3,5	6	
437.05D25CP	19	17	14	M5x0,8	18	12	4	8	
437.06D40CP	19	17	14	M6x1,0	18	11	4	8	
437.08D63CP	22	19	16	M8x1,25	22	16	4	10	
437.10D80CP	27	22	21	M10x1,5	28	20	4	14	
437.12D100CP	34	30	25	M12x1,75	33	24	5	18	

(Werte in mm)

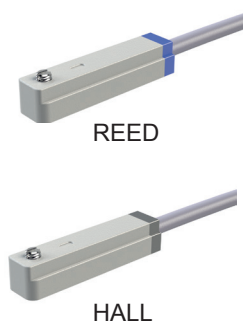
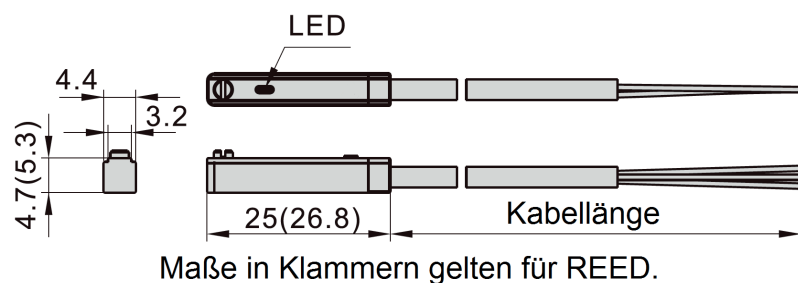
**Zubehör**
**Sensorschalter, Typ »CS1«  
235.100–235.105**

**Technische Daten**

	REED, NO	HALL, NO, NPN	HALL, NO, PNP
Betriebsspannung	5...240 V AC/DC		5...30 V DC
Schaltstrom	100 mA		max. 30 V / 200 mA
Schaltspannung	max. 10 W		max. 6,0 W
Stromaufnahme	-		max. 5mA
Spannungsabfall	max. 2,5 V bei 100 mA DC		max. 0,7 V
Verluststrom	-		max. 0,01 mA
Max. Frequenz	200 Hz		1000 Hz
Stoßfestigkeit		50 g	
Schutzschaltung	-	verpolungssicher, Überspannungsschutz	
Temperaturbereich	-10 °C bis 70 °C *		-10 °C bis 70 °C
Schutzart	IP 64		IP 64 **

\* Hochtemperaturausführung bis 125 °C auf Anfrage verfügbar.

\*\* IP 68 auf Anfrage verfügbar; ausschließlich für Ausführungen mit offenem Kabel.

**Bestellinformationen**

Artikel Nr.	Typen Nr.	
<b>115527 *</b>	235.100	REED-Sensor, 2-Draht, M8-Stecker, 150 mm Kabel, NO
<b>115528</b>	235.101	REED-Sensor, 2-Draht, 3 m Kabel, NO
<b>115529</b>	235.102	HALL-Sensor, 3-Draht, M8-Stecker, 150 mm Kabel, NO, NPN
<b>115530</b>	235.103	HALL-Sensor, 3-Draht, 3 m Kabel, NO, NPN
<b>115531</b>	235.104	HALL-Sensor, 3-Draht, M8-Stecker, 150 mm Kabel, NO, PNP
<b>115532</b>	235.105	HALL-Sensor, 3-Draht, 3 m Kabel, NO, PNP

\*Bei dem Artikel Artikel Nr. 115527 (Typen Nr. 235.100) handelt es sich um einen Auslaufartikel. Verfügbar so lange der Vorrat reicht.  
Ersatzartikel Artikel Nr. 116943 (Typen Nr. 235.100-1). Diesen finden Sie auf der nachfolgenden Seite 9.

## PIN-Belegung

## M8-Stecker (2-Draht-Sensor)

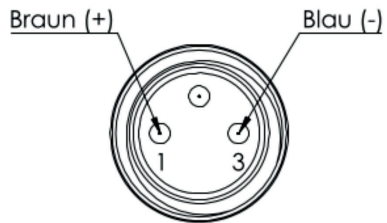

## M8-Stecker (3-Draht-Sensor)

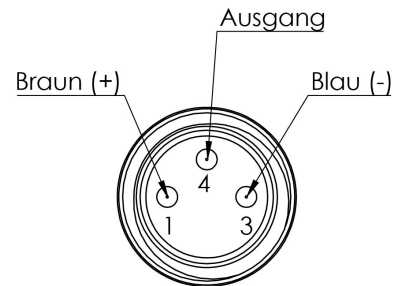

## Abmessungen Stecker

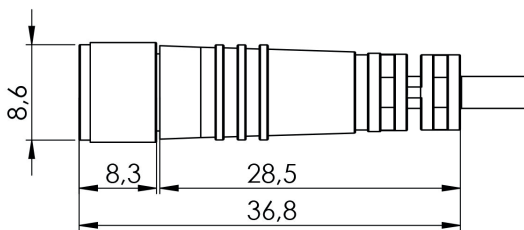



**Bestellinformationen**

Artikel Nr.	Typen Nr.	Beschreibung
116943	235.100-1	REED, 2-Draht, M8-Stecker, 150 mm Kabel, NO

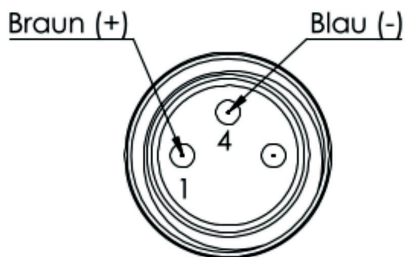
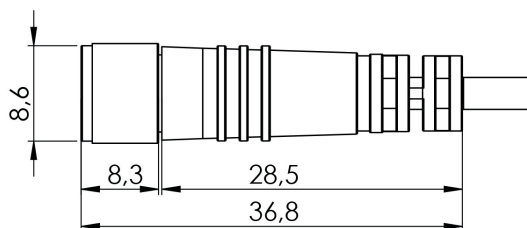
**PIN-Belegung**
**M8-Stecker (2-Draht-Sensor)**

**Abmessungen Stecker**

**Montage**

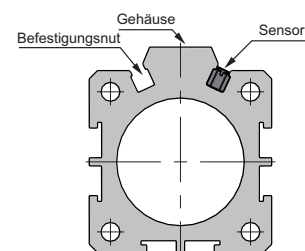
Kein Montagezubehör für die Sensoren (235.100–235.105) erforderlich. Diese können direkt in die Nuten des Zylindergehäuses geschoben und festgeschraubt werden.

1. Lösen Sie die Spannschraube am Sensor.
2. Sensor in Nut einführen und in die gewünschte Position schieben.
3. Befestigungsschraube festdrehen.



## Bestellinformationen

Artikel Nr.	Typen Nr.
13.DM.12005	115261
13.DM.12010	115262
13.DM.12015	115263
13.DM.12020	115264
13.DM.12025	115265
13.DM.12030	115266
13.DM.12035	115267
13.DM.12040	115268
13.DM.12045	115269
13.DM.12050	115270
13.DM.12055	115271
13.DM.12060	115272
13.DM.16005	115273
13.DM.16010	115274
13.DM.16015	115275
13.DM.16020	115276
13.DM.16025	115277
13.DM.16030	115278
13.DM.16035	115279
13.DM.16040	115280
13.DM.16045	115281
13.DM.16050	115282
13.DM.16055	115283
13.DM.16060	115284
13.DM.20005	115285
13.DM.20010	115286
13.DM.20015	115287
13.DM.20020	115288
13.DM.20025	115289
13.DM.20030	115290
13.DM.20035	115291
13.DM.20040	115292
13.DM.20045	115293
13.DM.20050	115294
13.DM.20055	115295
13.DM.20060	115296
13.DM.20065	115297
13.DM.20070	115298
13.DM.20075	115299
13.DM.20080	115300
13.DM.25005	115301
13.DM.25010	115302
13.DM.25015	115303
13.DM.25020	115304
13.DM.25025	115305
13.DM.25030	115306
13.DM.25035	115307

## Bestellinformationen

Artikel Nr.	Typen Nr.
13.DM.25040	115308
13.DM.25045	115309
13.DM.25050	115310
13.DM.25055	115311
13.DM.25060	115312
13.DM.25065	115313
13.DM.25070	115314
13.DM.25075	115315
13.DM.25080	115316
13.DM.32005	115317
13.DM.32010	115318
13.DM.32015	115319
13.DM.32020	115320
13.DM.32025	115321
13.DM.32030	115322
13.DM.32035	115323
13.DM.32040	115324
13.DM.32045	115325
13.DM.32050	115326
13.DM.32055	115327
13.DM.32060	115328
13.DM.32065	115329
13.DM.32070	115330
13.DM.32075	115331
13.DM.32080	115332
13.DM.32085	115333
13.DM.32090	115334
13.DM.32095	115335
13.DM.32100	115336
13.DM.40005	115337
13.DM.40010	115338
13.DM.40015	115339
13.DM.40020	115340
13.DM.40025	115341
13.DM.40030	115342
13.DM.40035	115343
13.DM.40040	115344
13.DM.40045	115345
13.DM.40050	115346
13.DM.40055	115347
13.DM.40060	115348
13.DM.40065	115349
13.DM.40070	115350
13.DM.40075	115351
13.DM.40080	115352
13.DM.40085	115353
13.DM.40090	115354

## Bestellinformationen

Artikel Nr.	Typen Nr.
13.DM.40095	115355
13.DM.40100	115356
13.DM.50005	115357
13.DM.50010	115358
13.DM.50015	115359
13.DM.50020	115360
13.DM.50025	115361
13.DM.50030	115362
13.DM.50035	115363
13.DM.50040	115364
13.DM.50045	115365
13.DM.50050	115366
13.DM.50055	115367
13.DM.50060	115368
13.DM.50065	115369
13.DM.50070	115370
13.DM.50075	115371
13.DM.50080	115372
13.DM.50085	115373
13.DM.50090	115374
13.DM.50095	115375
13.DM.50100	115376
13.DM.63005	115377
13.DM.63010	115378
13.DM.63015	115379
13.DM.63020	115380
13.DM.63025	115381
13.DM.63030	115382
13.DM.63035	115383
13.DM.63040	115384
13.DM.63045	115385
13.DM.63050	115386
13.DM.63055	115387
13.DM.63060	115388
13.DM.63065	115389
13.DM.63070	115390
13.DM.63075	115391
13.DM.63080	115392
13.DM.63085	115393
13.DM.63090	115394
13.DM.63095	115395
13.DM.63100	115396
13.DM.80005	115397
13.DM.80010	115398
13.DM.80015	115399
13.DM.80020	115400
13.DM.80025	115401

**Bestellinformationen**

Artikel Nr.	Typen Nr.
13.DM.80030	115402
13.DM.80035	115403
13.DM.80040	115404
13.DM.80045	115405
13.DM.80050	115406
13.DM.80055	115407
13.DM.80060	115408
13.DM.80065	115409
13.DM.80070	115410
13.DM.80075	115411
13.DM.80080	115412
13.DM.80085	115413
13.DM.80090	115414
13.DM.80095	115415
13.DM.80100	115416
13.DM.100005	115241
13.DM.100010	115242
13.DM.100015	115243
13.DM.100020	115244
13.DM.100025	115245
13.DM.100030	115246
13.DM.100035	115247
13.DM.100040	115248
13.DM.100045	115249
13.DM.100050	115250
13.DM.100055	115251
13.DM.100060	115252
13.DM.100065	115253
13.DM.100070	115254
13.DM.100075	115255
13.DM.100080	115256
13.DM.100085	115257
13.DM.100090	115258
13.DM.100095	115259
13.DM.100100	115260

**Bestellinformationen**

Artikel Nr.	Typen Nr.
437.400	115839
437.402	115840
437.403	115841
437.404	115842
437.405	115843
437.406	115844
437.407	115845
437.408	115846
437.409	115847
437.410	115848
437.412	115849
437.413	115850
437.414	115851
437.415	115852
437.416	115853
437.417	115854
437.418	115855
437.419	115856
437.420	115857
437.422	115858
437.423	115859
437.424	115860
437.425	115861
437.426	115862
437.427	115863
437.428	115864
437.429	115865
438.03D12CP	115896
438.04D16CP	115898
438.05D20CP	115900
438.05D25CP	115902
438.06D40CP	115904
438.08D63CP	115906
438.10D80CP	115908
438.12D100CP	115909
437.03D12CP	115741
437.04D16CP	115743
437.05D25CP	115746
437.06D40CP	115748
437.08D63CP	115750
437.10D80CP	115759
437.12D100CP	115771
235.100	115527
235.101	115528
235.102	115529
235.103	115530
235.104	115531
235.105	115532