



Kraus & Naimer

BLUE LINE switchgear

since 1907

Catalog 120 Control Switches

04/2010

CG, CH and CHR type up to 25 A



Kraus & Naimer

The development of the Blue Line rotary switch, contactor and motor starter product ranges is based on more than hundred years experience by Kraus & Naimer in the design and manufacture of electrical switchgear. Kraus & Naimer pioneered the introduction of the cam operated rotary switch and continues to be recognized as the world leader in that product field.

BLUE LINE

Blue Line products are protected by numerous patents throughout the industrial world. They are built to national and international standards and designed to withstand adverse temperatures and climates.

Blue Line products are accepted and universally recognized for their quality and workmanship. They are supported by a worldwide sales and service organization.

The Kraus & Naimer Registered Trademark



WORLDWIDE SYMBOL
FOR QUALITY SWITCHGEAR

Disconnectors and Main Switches acc. to IEC 60947-3 see Catalog 500

Contents	Page
Construction Data	2
Dimensions and Nominal Ratings	3
How to order	4, 5
Switch Function and Configuration	
ON/OFF Switches	6, 7
Double-throw Switches	8-10
General Application Switches	10
Coding Switches	11
Multi-step Switches	12-14
Voltmeter Switches	15-17
Ammeter Switches	17-19
Volt-ammeter Switches	19
Control Switches	19, 20
Motor Switches	21-23
Types of Mounting	
Panel Mounting	24-27
Base Mounting	28, 29
Escutcheon Plates	30, 31
Handles	32
International Standards and Approvals	33
Technical Data	34-36
Dimensions	
Panel Mounting	37-40
Base Mounting	41, 42
Overall Switch Lengths	42, 43
Blue Line Switchgear: Summary	44

Construction Data

Cam switches of the CG, CH and CHR-series are designed for universal application and may ideally be used for control switches, instrumentation switches and motor control switches. Different contact designs, contact materials and terminals allow the use as well as in electronic circuitry and in aggressive environments in accordance with IEC 60947-3, EN 60947-3, VDE 0660 part 107, UL and cUL (cUR).

The stage is the basis for all switches and can be supplied with a maximum of 2 contacts. All switches of this series are supplied with open terminals which are accessible while the switch is installed. The terminals are protected against accidental finger contact according to EN 50274, VDE 0660 part 514 and BGV A3. Captive plus-minus terminal screws and integrated screwdriver guides facilitate wiring. Due to the particular arrangement of the terminals of the CG switches, it is possible

to install the switches closely, side by side, or to mount them directly at the cable trays. The contact terminal numbers are easy to read, even if the switch is installed.

The captive plus-minus screws of the CH and CHR-series are located about 90° apart from the terminal direction. This allows for connecting wires without any interference with the terminal screws.

For connection with ring type terminals the CHR-series were designed. The switches are supplied with large open terminals. This allows for connection without removing the screws.

3 different Contact Systems are available

CG6 to
CHR16B

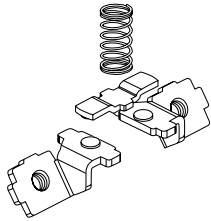

A rigid, double-break bridge with silver alloy contacts provides high making and breaking capabilities for regular control applications.

CG4 and
CG4-1

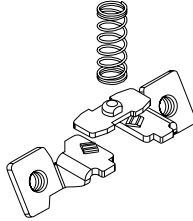

High contact reliability by multiple cross-point contacts, CG4 with 1 μ and CG4-1 with 35 μ gold plating.

CGD4-1

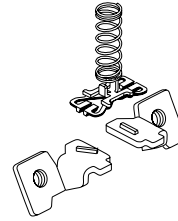

High contact reliability by H-bridge design with "cross-wire" contacts. The contact system with gold-plated contacts (CH12/CHR12 with silver contact) allows for low voltages, electronic compatible.

CH11/CHR11
CH12/CHR12

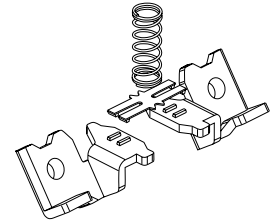

Type	Size	Possible Switching Angles	Max. No. of Stages
CG4-CGD4-1	S00	30°, 45°, 60°, 90°	8
CG6-CHR6	S00	30°, 45°, 60°, 90°	4
CG8-CHR16	S0	30°, 45°, 60°, 90°	12
CG8B	S1	30°, 45°, 60°, 90°	12
CH10B-CHR16B	S1	30°, 45°, 60°, 90°	12
CG8S	S0	60°	on request

CG-series

CH-series

CHR-series

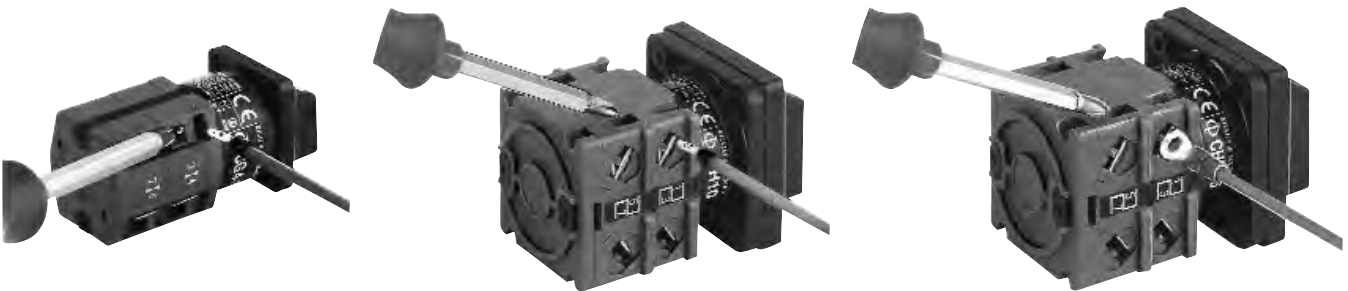

Above illustrates the standard terminal positions.

Nominal Ratings

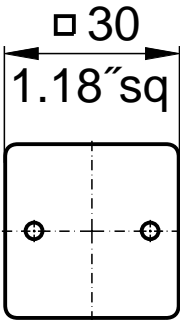
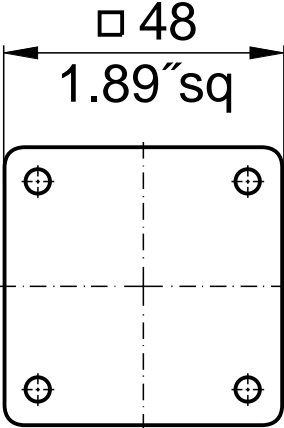
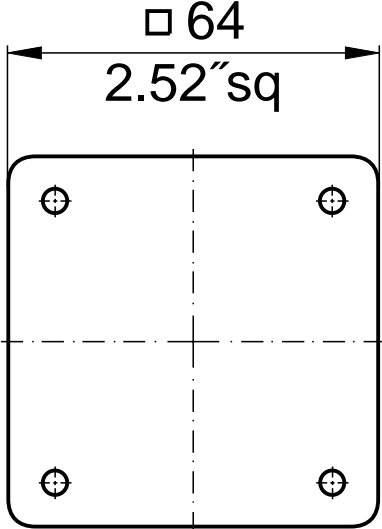
Switch Size	Type	According to IEC 60947-3, EN 60947-3, VDE 0660 part 107			
		Operational Voltage ¹ U_e V	Thermal Current I_u/I_{th} A	Motor Rating 3 x 380 V-440 V AC-23A AC-3 kW kW	
S00 	CG4	440	10	3	2,2
	CG4-1	440	10	3	2,2
	CGD4-1	440	5	-	-
	CG6	690	20	7,5	5,5
	CH6	690	20	7,5	5,5
	CHR6	690	20	7,5	5,5
S0 	CG8	690	20	7,5	5,5
	CH10	690	20	7,5	5,5
	CH11	600	6	-	-
	CH12	600	6	-	-
	CH16	690	25	11	7,5
	CHR10	690	20	7,5	5,5
	CHR11	600	6	-	-
	CHR12	600	6	-	-
	CHR16	690	25	11	7,5
S1 	CH10B	690	20	7,5	5,5
	CH16B	690	25	11	7,5
	CHR10B	690	20	7,5	5,5
	CHR16B	690	25	11	7,5

For further technical details, refer to pages 34-36.

¹Valid for lines with grounded common neutral termination, overvoltage category III, pollution degree 3. Values for other supply systems on request.

How to order

Disconnectors and Main Switches according to IEC 60947-3 see Catalog 500

Three types of data (shown below) are required for ordering Blue Line cam-operated switches. Code numbers for ordering are shown in this catalog.

1. Type of Switch

The type of switch required may be easily selected by referring to the table on page 3 which shows the thermal current, power rating and dimensions of each switch. For further technical details, refer to pages 34-36. Variations of contacts and terminals are shown below.

2. Switch Function

The code numbers for standard switches shown on pages 6-23 indicate the switch function, escutcheon plate, handle and any optional extras.

Additional coding to modify type and color of handle and escutcheon plate is explained below.

3. Type of Mounting

Types of mounting are shown on pages 24-29. Catalog **101** describes enclosures and optional extras.

Specify the mounting code to indicate required mounting.

CH10

A202-600

VE

Type of Switch

Extending the switch type coding the following combinations will define:

Amendment	Definition	For switch types
-1	with gold contacts ¹	CH6, CHR6, CH10, CHR10, CH10B, CHR10B
-4 ²	with quick connects (nickel-plated)	CH6, CH10, CH16, CH10B, CH16B
-6 ²	with angled quick connects (nickel-plated)	CH6, CH10, CH16, CH10B, CH16B
B	S0 switches with latching mechanism size S1	CG8, CH10, CH16, CHR10, CHR16 for four hole panel mounting
L	with lockout-relay w/o manual release	CG8, CH10, CH16, CHR10, CHR16
M	with lockout-relay with manual release	CG8, CH10, CH16, CHR10, CHR16
X	with power failure release	CG8, CH10, CH16, CHR10, CHR16
R	with spring return latching mechanism	CG8, CH10, CH16
S	with snap action	CG8, CH10, CH16, CHR10, CHR16 with 60° or 90° switching

Example: Coding for switch type **CH10** with latching mechanism size S1 is **CH10B**.

Modification of Switches

The part number for switch function and options may be modified in cases where items are required other than standard. The modification may involve the escutcheon plate inscription, color combination of escutcheon plate and handle, type of escutcheon plate and handle or the optional extra.

Switch Size	Escutcheon Plate Frame	Handle	Escutcheon Plate Backing	Escutcheon Plate Lettering	Dash Number
S0, S1	electro-gray	electro-gray	brushed alu	black	-100
S0, S1	electro-gray	electro-gray	black	mat silver	-500
S00, S0, S1	black	black	brushed alu	black	-600
S00, S0, S1	black	black	black	mat silver	-700

How to order

Modification of Switches

The standard switch consists of a transparent escutcheon plate with brushed aluminum backing and black inscription. The escutcheon plate frame is black as well as the handle. Page 4 shows further color combinations of escutcheon plate and handle which are available. The appropriate dash number must be substituted in the switch function coding to specify other color combinations as required.

Example: The complete coding for switch type CG8 with a 3 pole ON/OFF switch function, electro-gray handle and electro-gray escutcheon plate frame with brushed aluminum backing and black inscription which reads 0-1 is as follows: **CH10 A202-100 E**.

The following is a list of special programs for escutcheon plate and handle combinations. They may be obtained by specifying any one of the following two (2) digit dash numbers as a part of the overall dash number. It is still necessary to prefix these two digit numbers with the first digit which represents the color combination desired.

Special programs for escutcheon plate and handle combinations

- **00** = without escutcheon plate, without handle
- **01** = without escutcheon plate
- **02** = without handle
- **03** = with square escutcheon plate without lettering
- **04** = with rectangular escutcheon plate without lettering
- **05** = with square escutcheon plate without lettering and without handle
- **06** = with rectangular escutcheon plate without lettering and without handle
- **07** = standard escutcheon plate, without lettering on rectangular section
- **08** = with F-handle
- **09** = with P-handle
- **10** = escutcheon plate frame and fixation ring only (if using switches with single hole mounting: - **16**)
- **11** = without escutcheon plate, but with handle bearing plate
- **12** = with yellow escutcheon plate backing and red handle
- **14** = with B-handle
- **16** = escutcheon plate frame and fixation ring only if using switches with single hole mounting
- **17** = standard escutcheon plate and rectangular add-on escutcheon plate if using switches with single hole mounting FT2

Example: The complete coding for switch type CG8 with a 3 pole ON/OFF switch function with electro-gray escutcheon plate frame, square escutcheon plate without lettering, brushed aluminum plate backing and electro-gray handle reads as follows: **CH10 A202-103 E**.

Handles, Escutcheon Plates and Optional Extras

The handles for standard switches shown on pages 6-23 are suitable for mounting units with four hole mounting. Alternative types of handles available are illustrated on pages 24-29. When a handle, escutcheon plate or optional extra is required but not covered by the dash number, the code number for the selected component should be entered separately. A comprehensive range of available standard escutcheon plates is illustrated on pages 30-32. Non-standard or special escutcheon plate engravings are available at extra cost. The large number of optional extras and enclosures is covered in Catalog 101.

Switch Size

CG, CH and CHR switches are available in sizes S00, S0 and S1. These size codes indicate the dimension of the mounting, the escutcheon plate and the handle, as well as the size of optional devices and enclosures. Page 3 lists these sizes and the various switch types they include.

Ordering of Special Switches and Escutcheon Plates

When ordering special switches and escutcheon plates it is advisable to use our order form, as illustrated. The customer's requirements are shown in blue as an example.

For technical reasons, it may not be possible to follow the sequence of contacts requested by the customer. The final contact development which is sent with every switch will show the customer's original terminal markings.

SWITCH	ESCUFCHON PLATE																			HANDLE																																																																																																																																																																																																																																																																																																																																																																																																																																																																																																																																																																																																																																																																																																																																																																																																																																																																																																																																																																																																																					
: CH16	MOTOR 1																			: G251																																																																																																																																																																																																																																																																																																																																																																																																																																																																																																																																																																																																																																																																																																																																																																																																																																																																																																																																																																																																																					
OPTIONAL	POSITIONS																			EXTRAS																																																																																																																																																																																																																																																																																																																																																																																																																																																																																																																																																																																																																																																																																																																																																																																																																																																																																																																																																																																																																					
: MO04	O	1	2	3	4	5	6	7	8	9	10	11	12	13	14	15	16	17	18	19	20	21	22	23	24	25	26	27	28	29	30	31	32	33	34	35	36	37	38	39	40	41	42	43	44	45	46	47	48	49	50	51	52	53	54	55	56	57	58	59	60	61	62	63	64	65	66	67	68	69	70	71	72	73	74	75	76	77	78	79	80	81	82	83	84	85	86	87	88	89	90	91	92	93	94	95	96	97	98	99	100	101	102	103	104	105	106	107	108	109	110	111	112	113	114	115	116	117	118	119	120	121	122	123	124	125	126	127	128	129	130	131	132	133	134	135	136	137	138	139	140	141	142	143	144	145	146	147	148	149	150	151	152	153	154	155	156	157	158	159	160	161	162	163	164	165	166	167	168	169	170	171	172	173	174	175	176	177	178	179	180	181	182	183	184	185	186	187	188	189	190	191	192	193	194	195	196	197	198	199	200	201	202	203	204	205	206	207	208	209	210	211	212	213	214	215	216	217	218	219	220	221	222	223	224	225	226	227	228	229	230	231	232	233	234	235	236	237	238	239	240	241	242	243	244	245	246	247	248	249	250	251	252	253	254	255	256	257	258	259	260	261	262	263	264	265	266	267	268	269	270	271	272	273	274	275	276	277	278	279	280	281	282	283	284	285	286	287	288	289	290	291	292	293	294	295	296	297	298	299	300	301	302	303	304	305	306	307	308	309	310	311	312	313	314	315	316	317	318	319	320	321	322	323	324	325	326	327	328	329	330	331	332	333	334	335	336	337	338	339	340	341	342	343	344	345	346	347	348	349	350	351	352	353	354	355	356	357	358	359	360	361	362	363	364	365	366	367	368	369	370	371	372	373	374	375	376	377	378	379	380	381	382	383	384	385	386	387	388	389	390	391	392	393	394	395	396	397	398	399	400	401	402	403	404	405	406	407	408	409	410	411	412	413	414	415	416	417	418	419	420	421	422	423	424	425	426	427	428	429	430	431	432	433	434	435	436	437	438	439	440	441	442	443	444	445	446	447	448	449	450	451	452	453	454	455	456	457	458	459	460	461	462	463	464	465	466	467	468	469	470	471	472	473	474	475	476	477	478	479	480	481	482	483	484	485	486	487	488	489	490	491	492	493	494	495	496	497	498	499	500	501	502	503	504	505	506	507	508	509	510	511	512	513	514	515	516	517	518	519	520	521	522	523	524	525	526	527	528	529	530	531	532	533	534	535	536	537	538	539	540	541	542	543	544	545	546	547	548	549	550	551	552	553	554	555	556	557	558	559	560	561	562	563	564	565	566	567	568	569	570	571	572	573	574	575	576	577	578	579	580	581	582	583	584	585	586	587	588	589	590	591	592	593	594	595	596	597	598	599	600	601	602	603	604	605	606	607	608	609	610	611	612	613	614	615	616	617	618	619	620	621	622	623	624	625	626	627	628	629	630	631	632	633	634	635	636	637	638	639	640	641	642	643	644	645	646	647	648	649	650	651	652	653	654	655	656	657	658	659	660	661	662	663	664	665	666	667	668	669	670	671	672	673	674	675	676	677	678	679	680	681	682	683	684	685	686	687	688	689	690	691	692	693	694	695	696	697	698	699	700	701	702	703	704	705	706	707	708	709	710	711	712	713	714	715	716	717	718	719	720	721	722	723	724	725	726	727	728	729	730	731	732	733	734	735	736	737	738	739	740	741	742	743	744	745	746	747	748	749	750	751	752	753	754	755	756	757	758	759	760	761	762	763	764	765	766	767	768	769	770	771	772	773	774	775	776	777	778	779	780	781	782	783	784	785	786	787	788	789	790	791	792	793	794	795	796	797	798	799	800	801	802	803	804	805	806	807	808	809	810	811	812	813	814	815	816	817	818	819	820	821	822	823	824	825	826	827	828	829	830	831	832	833	834	835	836	837	838	839	840	841	842	843	844	845	846	847	848	849	850	851	852	853	854	855	856	857	858	859	860	861	862	863	864	865	866	867	868	869	870	871	872	873	874	875	876	877	878	879	880	881	882	883	884	885	886	887	888	889	890	891	892	893	894	895	896	897	898	899	900	901	902	903	904	905	906	907	908	909	910	911	912	913	914	915	916	917	918	919	920	921	922	923	924	925	926	927	928	929	930	931	932	933	934	935	936	937	938	939	940	941	942	943	944	945	946	947	948	949	950	951	952	953	954	955	956	957	958	959	960	961	962	963	964	965	966	967	968	969	970	971	972	973	974	975	976	977	978	979	980	981	982	983	984	985	986	987	988	989	990	991	992	993	994	995	996	997	998	999	1000
DATE																																																																																																																																																																																																																																																																																																																																																																																																																																																																																																																																																																																																																																																																																																																																																																																																																																																																																																																																																																																																																																									
SIGNED																																																																																																																																																																																																																																																																																																																																																																																																																																																																																																																																																																																																																																																																																																																																																																																																																																																																																																																																																																																																																																									

Order forms are available on request.

Function	Escutch. Plate	Type/Handle				Code	Stages	Connection Diagram
		CG4- CGD4-1	CG6- CHR6	CG8 CH10- CHR16	CH10B- CHR16B			

ON/OFF Switches with 60° Switching

1 pole						A200-600	1		
2 pole						A201-600	1		
3 pole						A202-600	2		
3 pole with red handle						A202-626	2		
3 pole with V850 padlock attachment						A202-627	2		
4 pole						A203-600	2		
4 pole 1 pole preclose 6° ¹					A653-600	2			
5 pole					A341-600	3			
6 pole					A342-600	3			
7 pole					A343-600	4			
8 pole					A344-600	4			
8 pole 2 pole preclose 6° ¹					A654-600	4			
9 pole					A345-600	5			
10 pole					A346-600	5			
11 pole					A347-600	6			
12 pole					A348-600	6			
1 pole						A200-620	1		
2 pole						A201-620	1		
3 pole						A202-620	2		
4 pole						A203-620	2		
4 pole 1 pole preclose 6° ¹						A653-620	2		
5 pole						A341-620	3		
6 pole					A342-620	3			
7 pole					A343-620	4			
8 pole					A344-620	4			
8 pole 2 pole preclose 6° ¹					A654-620	4			
9 pole					A345-620	5			
10 pole					A346-620	5			
11 pole					A347-620	6			
12 pole					A348-620	6			
1 pole						A200-621	1		
2 pole						A201-621	1		
3 pole						A202-621	2		
4 pole						A203-621	2		
4 pole 1 pole preclose 6° ¹						A653-621	2		
5 pole						A341-621	3		
6 pole					A342-621	3			
1 pole						A200-622	1		
2 pole						A201-622	1		
3 pole						A202-622	2		
4 pole						A203-622	2		
4 pole 1 pole preclose 6° ¹						A653-622	2		
5 pole						A341-622	3		
6 pole					A342-622	3			
1 pole						A200-623	1		
2 pole						A201-623	1		
3 pole						A202-623	2		
4 pole						A203-623	2		
4 pole 1 pole preclose 6° ¹						A653-623	2		
5 pole						A341-623	3		
6 pole					A342-623	3			
1 pole						A200-624	1		
2 pole						A201-624	1		
3 pole						A202-624	2		
4 pole						A203-624	2		
4 pole 1 pole preclose 6° ¹						A653-624	2		
5 pole						A341-624	3		
6 pole					A342-624	3			
1 pole						A200-625	1		
2 pole						A201-625	1		
3 pole						A202-625	2		
4 pole						A203-625	2		
4 pole 1 pole preclose 6° ¹						A653-625	2		
5 pole						A341-625	3		
6 pole					A342-625	3			

¹For use in a three phase four-wire system with switched neutral.

Function	Escutch. Plate	Type/Handle				Code	Stages	Connection Diagram
		CG4- CGD4-1	CG6- CHR6	CH10- CHR16	CH10B- CHR16B			

ON/OFF Switches with 90° Switching

1 pole contacts						A290-600	1		1, 2, 3, 4, 5 and 6 pole			
2 pole preclose 30°						A291-600	1					
3 pole						A292-600	2					
4 pole						A324-600	2					
4 pole 1 pole preclose 60° ¹						A293-600	2					
4 pole 3 pole preclose 30°						A327-600	2					
5 pole contacts						A290-620	1		4 pole 1 pole preclose 60°			
2 pole preclose 30°						A291-620	1					
3 pole						A292-620	2					
4 pole						A324-620	2					
4 pole 1 pole preclose 60° ¹						A293-620	2					
4 pole 3 pole preclose 30°						A327-620	2					
5 pole contacts						A325-620	3				4 pole 3 pole preclose 30°	
6 pole preclose 30°						A326-620	3					
3 pole 360° rotation							A208-600			2		
										A208-620		
3 pole for foot operation						A386-600	2					

ON/OFF Switches with 30° Switching

1 pole						A100-600	1		1-4 pole
2 pole						A101-600	1		
3 pole						A102-600	2		
4 pole						A103-600	2		
1 pole with spring return						A204-600	1		1-4 pole
2 pole with spring return						A205-600	1		
3 pole with spring return						A206-600	2		
4 pole with spring return						A207-600	2		
1 pole with spring return						A204-620	1		
2 pole with spring return						A205-620	1		
3 pole with spring return						A206-620	2		
4 pole with spring return						A207-620	2		

¹For use in a three phase four-wire system with switched neutral. ²available as switch types CH16B and CHR16B

Function	Escutch. Plate	Type/Handle				Code	Stages	Connection Diagram ²
		CG4- CGD4-1	CG6- CHR6	CH10- CHR16	CH10B- CHR16B			

Double-throw Switches without „OFF“ 60° Switching

1 pole						A220-600	1		
2 pole						A221-600	2		
3 pole						A222-600	3		
4 pole						A223-600	4		
4 pole 1 pole preclose 6° ¹						A673-600	4		1-4 pole 4 pole 1 pole preclose 6°
5 pole						A369-600	5		
6 pole						A370-600	6		
7 pole						A371-600	7		
8 pole						A372-600	8		
8 pole 2 pole preclose 6° ¹						A972-600	8		5 pole
9 pole						A373-600	9		6 and 7 pole
10 pole						A374-600	10		8 and 9 pole
11 pole					A375-600	11	8 pole 2 pole preclose 6°		
12 pole					A376-600	12	10 and 11 pole		
								12 pole	

Double-throw Switches without „OFF“ with electrically isolated contacts

1 pole						A720-600	1	
2 pole						A721-600	2	
3 pole						A722-600	3	
4 pole						A723-600	4	
4 pole 1 pole preclose 6° ¹						A973-600	4	
1 pole with spring return						A795-600	1	1 pole with spring return

Double-throw Switches without „OFF“ 30° Switching

1 pole						A120-600	1	
2 pole						A121-600	2	
3 pole						A122-600	3	
4 pole						A123-600	4	
1 pole with spring return						A295-600	1	
2 pole with spring return						A296-600	2	
3 pole with spring return						A297-600	3	
1 pole with spring return						A295-620	1	
2 pole with spring return						A296-620	2	
3 pole with spring return						A297-620	3	

¹For use in a three phase four-wire system with switched neutral. ²Connection diagrams for CHR switches on request.

Function	Escutch. Plate	Type/Handle				Code	Stages	Connection Diagram ²
		CG4- CGD4-1	CG6- CHR6	CG8- CH10- CHR16	CH10B- CHR16B			

Double-throw Switches with Center „OFF“ 60° Switching

1 pole 2 pole 3 pole 4 pole 4 pole 1 pole preclose 6° ¹ 5 pole 6 pole 7 pole 8 pole 8 pole 2 pole preclose 6° ¹						A210-600 A211-600 A212-600 A213-600 A913-600 A361-600 A362-600 A363-600 A364-600 A664-600	1 2 3 4 4 5 6 7 8 8	
1 pole 2 pole 3 pole 4 pole 4 pole 1 pole preclose 6° ¹ 5 pole 6 pole 7 pole 8 pole 8 pole 2 pole preclose 6° ¹						A210-620 A211-620 A212-620 A213-620 A913-620 A361-620 A362-620 A363-620 A364-620 A664-620	1 2 3 4 4 5 6 7 8 8	
1 pole 2 pole 3 pole						A210-621 A211-621 A212-621	1 2 3	
1 pole 2 pole 3 pole						A210-622 A211-622 A212-622	1 2 3	
1 pole 2 pole 3 pole						A210-623 A211-623 A212-623	1 2 3	
1 pole 2 pole 3 pole 4 pole 4 pole 1 pole preclose 6° ¹						A210-624 A211-624 A212-624 A213-624 A913-624	1 2 3 4 4	

Double-throw Switches with Center „OFF“ 90° Switching

1 pole 2 pole 3 pole 4 pole 1 pole preclose 6° ¹						A218-600 A219-600 A299-600 A294-600	1 2 3 4	
1 pole 2 pole 3 pole 4 pole 1 pole preclose 6° ¹						A218-620 A219-620 A299-620 A294-620	1 2 3 4	

Double-throw Switches with Center „OFF“ and electrically isolated contacts

1 pole 2 pole 3 pole 4 pole 4 pole 1 pole preclose 6° ¹						A710-600 A711-600 A712-600 A713-600 A963-600	1 2 3 4 4	
1 pole with spring return 2 pole to center						A714-600 A715-600	1 2	

¹For use in a three phase four-wire system with switched neutral. ²Connection diagrams for CHR switches on request.

Function	Escutch. Plate	Type/Handle				Code	Stages	Connection Diagram ¹
		CG4- CGD4-1	CG6- CHR6	CH10- CHR16	CH10B- CHR16B			

Double-throw Switches with Spring Return to Center

1 pole with spring return 2 pole to center 3 pole						A214-600	1	<p>1-3 pole</p>
						A215-600	2	
						A216-600	3	
1 pole 2 pole 3 pole						A214-620	1	
						A215-620	2	
						A216-620	3	
1 pole with spring return 2 pole from left to center 3 pole						A320-600	1	<p>1-3 pole</p>
						A321-600	2	
						A322-600	3	
1 pole 2 pole 3 pole						A320-621	1	
						A321-621	2	
						A322-621	3	

General Application Switches

1 pole 2 Gang 2 pole Switching sequence: 3 pole 0, A, A+B						A310-600	1	<p>1 pole 2 pole</p>	
						A312-600	2		
						A314-600	3		
1 pole 2 pole 3 pole						A310-620	1		<p>3 pole</p>
						A312-620	2		
						A314-620	3		
1 pole 3 Gang 2 pole Switching sequence: 3 pole 0, A, A+B, A+B+C						A311-600	2	<p>1 pole 2 pole</p>	
						A313-600	3		
						A315-600	5		
1 pole 2 pole 3 pole						A311-620	2		<p>3 pole</p>
						A313-620	3		
						A315-620	5		
1 pole 2 Gang 2 pole Series switching 3 pole Switching sequence: 0, A, B, A+B						A330-600	1	<p>1 pole 2 pole</p>	
						A331-600	2		
						A332-600	3		
1 pole 2 pole 3 pole						A330-620	1		<p>3 pole</p>
						A331-620	2		
						A332-620	3		
2 pole 2 Gang Series-parallel Switching						A339-600	2		
						A339-620	2		

¹Connection diagrams for CHR switches on request.

Function	Escutch. Plate	Type/Handle				Code	Stages	Connection Diagram
		CG4- CGD4-1	CG6- CHR6	CH11 CH12	CH10B- CHR16B			

Coding Switches/Binary Code

0 - 7 360° rotation					A540-600	2	
0 - 7 complement 360° rotation					A541-600	2	
0 - 7 + complement 360° rotation					A542-600	3	
0 - 9					A550-600	2	
0 - 9 complement					A551-600	2	
0 - 9 + complement					A552-600	4	
0 - 11 360° rotation					A543-600	2	
0 - 11 + complement 360° rotation					A545-600	4	

Function	Escutch. Plate	Type/Handle				Code	Stages	Connection Diagram ¹
		CG4- CGD4-1	CG6- CHR6	CG8 CH10- CHR16	CH10B- CHR16B			

Multi-step Switches without „OFF“

1 pole 2 pole 3 pole 4 pole 5 pole 6 pole						A230-600 A250-600 A270-600 A476-600 A484-600 A489-600	2 3 5 6 8 9	
1 pole 2 pole 3 pole 4 pole 5 pole 6 pole						A231-600 A251-600 A271-600 A477-600 A485-600 A490-600	2 4 6 8 10 12	
1 pole 2 pole 3 pole 4 pole						A232-600 A252-600 A272-600 A478-600	3 5 8 10	
1 pole 2 pole 3 pole						A233-600 A253-600 A273-600	3 6 9	
1 pole 2 pole 3 pole						A234-600 A254-600 A274-600	4 7 11	
1 pole 2 pole 3 pole						A235-600 A255-600 A275-600	4 8 12	
1 pole 9 Step						A236-600	5	
1 pole 10 Step						A237-600	5	
1 pole 11 Step						A238-600	6	
1 pole 12 Step 1 pole 360° rotation						A239-600 A639-600	6 6	

¹Connection diagrams for CHR switches on request.

Function	Escutch. Plate	Type/Handle				Code	Stages	Connection Diagram ¹
		CG4- CGD4-1	CG6- CHR6	CH10- CHR16	CH10B- CHR16B			

Multi-step Switches without „OFF“ with electrically isolated contacts

1 pole 3 Step						A730-600	2	 1 pole
2 pole						A750-600	3	 2 pole
1 pole 4 Step						A731-600	2	 1 pole
2 pole						A751-600	4	 2 pole

Multi-step Switches with „OFF“

1 pole 2 Step						A240-600	1	 1-6 pole
2 pole						A260-600	2	
3 pole						A280-600	3	
4 pole						A480-600	4	
5 pole						A486-600	5	
6 pole						A491-600	6	
1 pole						A240-620	1	1-6 pole
2 pole						A260-620	2	
3 pole						A280-620	3	
4 pole						A480-620	4	
5 pole						A486-620	5	
6 pole						A491-620	6	
1 pole 3 Step						A241-600	2	 1 and 2 pole
2 pole						A261-600	3	
3 pole						A281-600	5	
4 pole						A481-600	6	
5 pole						A487-600	8	
1 pole						A241-620	2	3 pole
2 pole						A261-620	3	
3 pole						A281-620	5	
4 pole						A481-620	6	
5 pole						A487-620	8	
1 pole						A241-621	2	4 pole
2 pole						A261-621	3	
								 5 pole

¹Connection diagrams for CHR switches on request.

Function	Escutch. Plate	Type/Handle				Code	Stages	Connection Diagram ¹
		CG4- CGD4-1	CG6- CHR6	CG8- CH10- CHR16	CH10B- CHR16B			

Multi-step Switches with „OFF“

1 pole 4 Step 2 pole 3 pole 4 pole						A242-600 A262-600 A282-600 A482-600	2 4 6 8	
1 pole 2 pole 3 pole 4 pole						A242-620 A262-620 A282-620 A482-620	2 4 6 8	1-4 pole
1 pole 5 Step 2 pole 3 pole						A243-600 A263-600 A283-600	3 5 8	
1 pole 2 pole 3 pole						A243-620 A263-620 A283-620	3 5 8	1-3 pole
1 pole 6 Step 2 pole 3 pole						A244-600 A264-600 A284-600	3 6 9	
1 pole 2 pole 3 pole						A244-620 A264-620 A284-620	3 6 9	1-3 pole
1 pole 7 Step 2 pole						A245-600 A265-600	4 7	
1 pole 2 pole						A245-620 A265-620	4 7	1 pole 2 pole
1 pole 8 Step						A246-600	4	
1 pole						A246-620	4	
1 pole 9 Step						A247-600	5	
1 pole						A247-620	5	
1 pole 10 Step						A248-600	5	
1 pole						A248-620	5	
1 pole 11 Step 1 pole 360° rotation						A249-600 A649-600	6 6	
1 pole 1 pole 360° rotation						A249-620 A649-620	6 6	

¹Connection diagrams for CHR switches on request.

Switch Function and Configuration

CG, CH, CHR Switches

Function	Escutch. Plate	Type/Handle				Code	Stages	Connection Diagram ¹
		CG4- CGD4-1	CG6- CHR6	CH10- CHR16	CH10B- CHR16B			

Voltmeter Switches without „OFF“

3 phase 3 wire						A023-600	2	
						A023-620	2	
3 phase 3 wire 3 phase to phase and phase to neutral						A025-600	3	
						A025-620	3	

Voltmeter Switches with „OFF“

2 pole 360° rotation						A002-600	1	
3 phase 3 wire						A004-600	2	
						A004-620	2	
						A004-621	2	
						A004-622	2	
						A004-623	2	
						A004-624	2	
						A011-600	2	

¹Connection diagrams for CHR switches on request.

Function	Escutch. Plate	Type/Handle				Code	Stages	Connection Diagram ¹
		CG4- CGD4-1	CG6- CHR6	CH10- CHR16	CH10B- CHR16B			

Voltmeter Switches with „OFF“

3 phase to neutral						A005-600	2	
						A005-620	2	
						A005-621	2	
						A005-622	2	
						A005-623	2	
3 phase to phase and 3 phase to neutral						A007-600	3	
						A007-620	3	
						A007-621	3	
						A007-622	3	
						A007-623	3	
						A007-624	3	
2 separate 3 phase with center „OFF“						A008-600	4	
						A008-620	4	
						A008-621	4	
						A008-622	4	

¹Connection diagrams for CHR switches on request.

Function	Escutch. Plate	Type/Handle				Code	Stages	Connection Diagram ¹
		CG4- CGD4-1	CG6- CHR6	CH10- CHR16	CH10B- CHR16B			

Voltmeter Switches with „OFF“

3 phase and 1 phase to neutral						A010-600	3	
						A010-620	3	
						A010-621	3	
						A010-622	3	

Ammeter Switches

Single pole with one current transformer						A046-600	1	
						A046-620	1	
						A046-621	1	
Single pole with 3 current transformers without „OFF“						A017-600	3	
						A017-620	3	
Single pole with 3 current transformers with „OFF“ 360° rotation						A048-600	3	
						A048-620	3	
						A048-621	3	
						A048-622	3	
						A048-623	3	

¹Connection diagrams for CHR switches on request.

Function	Escutch. Plate	Type/Handle				Code	Stages	Connection Diagram ¹
		CG4- CGD4-1	CG6- CHR6	CH10- CHR16	CH10B- CHR16B			

Ammeter Switches

Single pole with 2 current transformers (3 readings)						A021-600	2	
						A021-620	2	
Single pole with 4 current transformers						A036-600	4	
						A036-620	4	
2 pole 2 current transformers						A037-600	3	
						A037-620	3	
						A037-621	3	
2 pole 3 current transformers						A019-600	5	
						A019-620	5	
2 pole						A038-600	5	
						A038-620	5	
						A038-621	5	
2 pole 4 current transformers						A039-600	6	
						A039-620	6	

¹Connection diagrams for CHR switches on request.

Function	Escutch. Plate	Type/Handle				Code	Stages	Connection Diagram ¹
		CG4- CGD4-1	CG6- CHR6	CG8- CH10- CHR16	CH10B- CHR16B			

Volt-ammeter Switches

3 phase - phase to phase 3 current					A027-600	6	
					A028-600	7	
3 phase voltage 3 phase current 4 wire					A033-600	5	
3 phase voltage 3 phase current 3 wire					A035-600	5	

Control Switches

Stop switch					A174-600	1	
Start switch					A175-600	1	
Stop start switch single pole					A176-600	1	
Stop start switch 2 pole					A183-600	2	
Stop start switch with spring return from start to run					A178-600	1	
					A178-620	1	
Stop start switch with spring return to run for 2 units					A177-600	2	
					A177-620	2	

¹Connection diagrams for CHR switches on request.

Function	Escutch. Plate	Type/Handle				Code	Stages	Connection Diagram
		CG4- CGD4-1	CG6- CHR6	CH10- CHR16	CH10B- CHR16B			

Control Switches

Stop start switch with spring return to run with contactor interlock contactors for 2 units						A182-600	2	
						A182-620	2	
Motor voltage control switch						A150-600	2	

Control Switches with electrically isolated contacts

Stop start switch 1 pole						A789-600	1	
Stop start switch with spring return to 1						A791-600	1	
Stop start switch with spring return to run for 2 units						A790-600	2	
Contactor control with spring return to „OFF“						A179-600	2	
						A179-620	2	
Circuit breaker control						A537-600	2	

Control and Alarm Switches¹

With slip clutch and without indicator device						A190-600	5 ²	
Without indicator device						A192-600	2	

¹Advise the indicator device, described in Catalog 101, page 7. ²incl. slip clutch

Function	Escutch. Plate	Type/Handle				Code	Stages	Connection Diagram ¹
		CG4- CGD4-1	CG6- CHR6	CH10- CHR16	CH10B- CHR16B			

Motor Reversing Switches

2 pole						A400-600	2	
						A400-620	2	
						A400-621	2	
3 pole						A401-600	3	
						A401-620	3	
						A401-621	3	
3 pole with spring return to „OFF“						A228-600	3	
						A228-620	3	
3 pole for use with reversing contactors						A402-600	4	

Motor Control Switches

2 speed 2 winding 0-A-BY or Δ						A451-600	3	
						A451-620	3	
3 speed 2 winding 0-AΔ-BY-AΥ						A457-600	6	
						A457-620	6	

¹Connection diagrams for CHR switches on request.

Function	Escutch. Plate	Type/Handle				Code	Stages	Connection Diagram ¹
		CG4- CGD4-1	CG6- CHR6	CH10- CHR16	CH10B- CHR16B			















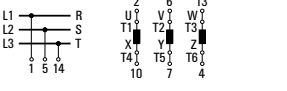









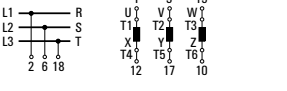

Motor Control Switches

2 speed single winding						A440-600	4	
						A440-620	4	
2 speed single winding without „OFF“						A466-600	4	
2 speed single winding with center „OFF“						A441-600	4	
						A441-620	4	
2 speed single winding reversing						A442-600	6	
						A442-620	6	
2 speed single winding for use with contactors						A444-600	5	
						A444-620	5	
2 speed reversing for 2 way operation with slip clutch for „OFF“ load use						A468-600	10 ²	
						A468-620	10 ²	

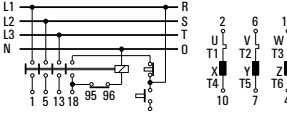





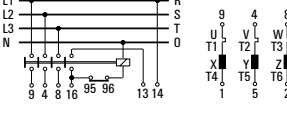







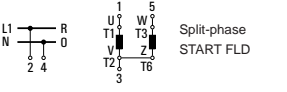







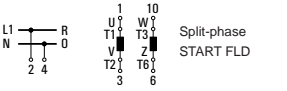

¹Connection diagrams for CHR switches on request. ²incl. slip clutch

Function	Escutch. Plate	Type/Handle				Code	Stages	Connection Diagram ¹
		CG4- CGD4-1	CG6- CHR6	CH10- CHR16	CH10B- CHR16B			

Star-delta Switches

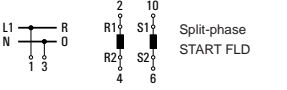

OFF-star-delta						A410-600	4	
						A410-620	4	
Reversing						A413-600	5	
With auxiliary contact closed in „OFF“ position						A416-600	5	
For use with reversing contactors						A419-600	4	

Start and Run Switches



Split-phase start						A425-600	2	
						A425-620	2	
Split-phase start reversing						A426-600	3	
						A426-620	3	
Split-phase reversing auto cutout of start field winding						A622-600	3	

¹Connection diagrams for CHR switches on request.





Two or Four Hole Panel Mounting	Terminals rotated 90°	Code	CG4-CHR6	CG8-CHR16	CH10B-CHR16B
--	-----------------------	-------------	----------	-----------	--------------

	Panel mounting					
	Two hole panel mounting	●	E E-V	● ●		
	Two hole panel mounting, protection IP 66	●	EF EF-V	● ●		
	Four hole panel mounting	●	E E-V	● ●	● ●	● ●
	Four hole panel mounting, protection IP 66	●	EF EF-V	● ●	● ●	● ●
	Two hole panel mounting, protection IP 65	●	E22 E22-V	● ●		
	Panel mounting using larger escutcheon plate and handle and with heavy duty latching					
	Four hole panel mounting		EG	●		
	Four hole panel mounting, protection IP 66		EGF	●		

Two Hole Panel Mounting or Mosaic Mounting	Code	CG4-CHR6
--	------	----------

	<p>Panel mounting with round shaft for combining with commercial radio knobs</p> <p>Two hole panel mounting Shaft diam. 6 mm/.24 inch</p> <p>Two hole panel mounting Shaft diam. 6,35 mm/.25 inch</p>	E9	●
	Mosaic mounting	E91	●
	For Siemens-Mosaic 30 mm grid depth	E92	●
	For Subklew-, Kreutzenbeck-, Symo-Mosaic 28 mm 25 mm 25 mm grid depth	E93	●
	For Mauell-Mosaic 30 mm grid depth	E94	●





Two or Four Hole Panel Mounting	Code	CG8-CHR16	CH10B-CHR16B
--	-------------	-----------	--------------

	<p>Panel mounting with heavy duty latching and metal shaft</p> <p>Four hole panel mounting Mounting plate, escutcheon plate and handle of size S0</p>	KN2	●	
	<p>Four hole panel mounting Mounting plate, escutcheon plate and handle of size S1</p>	KN1	●	●
	<p>Four hole panel mounting Mounting plate, escutcheon plate and handle of size S1 and 6 mm square metal shaft</p>	KD1	●	●
	<p>Panel mounting with protective cover</p> <p>Four hole panel mounting Protection front IP 40 rear IP 30</p> <p>Four hole panel mounting with additional shaft seal Protection front IP 65 rear IP 30</p>	EC	CH CHR	●
	<p>Four hole panel mounting Protection front IP 40 rear IP 42</p> <p>Four hole panel mounting with additional shaft seal Protection front IP 65 rear IP 42</p>	EC1		●
	<p>Two hole panel mounting Protection front IP 65 rear IP 42</p>	ED22	●	



Mounting

CG, CH, CHR Switches



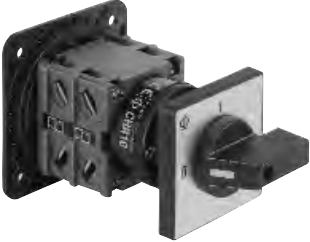

Single Hole Mounting	Terminals rotated 90°	Code	CG4-CHR6	CG8-CHR16
----------------------	-----------------------	-------------	----------	-----------

			Code	mm	mm
	With locking nut and shaft seal, protection IP 66 Without escutcheon plate	<ul style="list-style-type: none"> ● ● ● 	FS1 FS1-V FT1 FT1-V FT3 FT3-V	16/22 16/22	22 22 22/30 22/30
	With square escutcheon plate	<ul style="list-style-type: none"> ● ● ● 	FS2 FS2-V FT2 FT2-V FT4 FT4-V	16/22 16/22	22 22 22/30 22/30
	With size S1 square escutcheon plate and heavy duty latching	<ul style="list-style-type: none"> ● 	FH3 FH3-V		22 22
	With rectangular escutcheon plate	<ul style="list-style-type: none"> ● ● 	FS4 FS4-V FT6 FT6-V	16/22 16/22	22 22
	With size S1 rectangular escutcheon plate and heavy duty latching	<ul style="list-style-type: none"> ● 	FH4 FH4-V		22 22
	Mounting key for locking nut		S00 T170 09		

Base Mounting	Terminals rotated 90°	Code	CG4- CGD4-1	CG8- CHR16
---------------	-----------------------	------	----------------	---------------

	<p>Base mounting</p> <p>Base mounting - four hole</p> <p>For four hole base mounting and with integrated simplified door clutch, protection IP 65</p>	<p>●</p> <p>●</p>	<p>VE VE-V</p> <p>VF VF-V</p>	<p>●</p> <p>●</p>	<p>●</p> <p>●</p>
	<p>For two hole base mounting</p> <p>For two hole base mounting and with integrated simplified door clutch, protection IP 65</p>	<p>●</p> <p>●</p>	<p>VE22 VE22V</p> <p>VF22 VF22V</p>	<p>●</p> <p>●</p>	<p>●</p> <p>●</p>
	<p>Snap-on base mounting for track EN 60715.</p> <p>Snap-on base mounting for track EN 60715. Escutcheon plate can be fastened by screws at the switch.</p> <p>Snap-on base mounting for track EN 60715. Escutcheon plate fastened by single hole mounting at the switch e.g. for combining with key-lock device.</p>	<p></p> <p></p> <p></p>	<p>VE1</p> <p>VE1E</p> <p>VE1F</p>	<p></p> <p>●</p> <p>●</p>	<p>●</p> <p>●</p> <p>●</p>

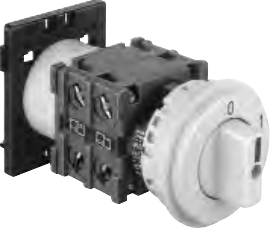
Base Mounting	Code	CG4- CGD4-1	CG8- CHR16
----------------------	-------------	----------------	---------------

Base mounting				
	<p>Snap-on base mounting for track EN 60715 with rectangular escutcheon plate for 45 mm standard knock-out.</p>	VE2		●
	<p>Snap-on base mounting for track EN 60715. Both the escutcheon plate for 45 mm standard knock-out and the handle are adjustable in height.</p>	VE21	●	●
	<p>Snap-on base mounting for track EN 60715 with circular escutcheon plate for 46 mm standard knock-out.</p>	VE3		●
	<p>Base mounting - four hole - for circular escutcheon plate with 46 mm knock-out.</p>	VE4		●

Escutcheon Plates

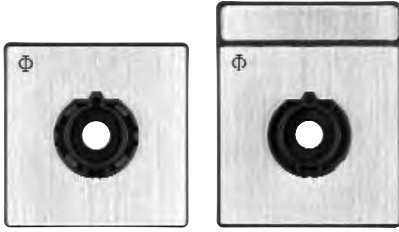

Square and rectangular escutcheon plates are available for each size of switch. The escutcheon plate consists of a frame and a faceplate having the switch positions which is then embossed with hot-foil backing. The escutcheon plate frame is an essential part of the switch and serves as a bearing surface for the handle. If the switch is to be mounted without an escutcheon plate we would recommend for size S1 the handle bearing plate T100-04.

Standard Letterings Available

(Over 500 standard letterings, special letterings upon request.)

30° switching

F022	F141	F158	F703	F023	F137	F142	F159	F701	F704	F152	F709	F026	F035	F153	F169	F024	F143
F160	F221	F222	F224	F025	F034	F036	F037	F038	F039	F139	F144	F147	F149	F150	F151	F219	F258
F259	F273	F280	F329	F384	F708	F053	F161	F297	F298	F306	F307	F001	F040	F052	F229	F355	F018
F019	F029	F030	F154	F155	F165	F166	F183	F184	F301	F302	F321	F332	F333	F334	F335	F374	F711
F712	F002	F021	F033	F041	F055	F305	F319	F054	F003	F042	F138	F255	F299	F308	F353	F350	F351
F004	F014	F017	F020	F027	F028	F031	F032	F043	F049	F135	F156	F157	F162	F167	F168	F187	F189
F303	F304	F336	F337	F347	F348	F710	F713	F714	F734	F005	F044	F136	F140	F702	F006	F010	F045
F015	F050	F007	F011	F046	F008	F012	F047	F016	F051	F009	F013	F048	F748				

45° switching

F747	F295	F742	F743	F215	F216	F738	F744	F746	F792	F793	F107	F109	F114	F115	F212	F213	F214
F217	F267	F289	F330	F375	F376	F383	F408	F409	F410	F411	F412	F413	F426	F427	F430	F729	F752
F775	F776	F777	F778	F779	F780	F781	F796	F797	F798	F105	F108	F112	F113	F117	F118	F293	F429
F739	F741	F419	F789	F790	F791	F794	F795	F110	F106	F116	F294	F317	F414	F415	F416	F417	F418
F782	F783	F784	F785	F786	F787	F788	F799	F111	F210	F211	F284	F285	F296	F322	F727	F740	

Escutcheon Plates

60° switching

F070	F087	F088	F089	F133	F197	F198	F232	F243	F247	F263	F268	F310	F311	F323	F328	F352	F367
F379	F380	F470	F754	F072	F163	F164	F192	F193	F196	F230	F231	F234	F244	F257	F262	F264	F282
F288	F291	F313	F382	F441	F705	F721	F722	F750	F757	F758	F075	F076	F098	F220	F223	F356	F357
F377	F723	F071	F073	F080	F081	F085	F086	F090	F091	F092	F093	F094	F104	F194	F235	F237	F239
F240	F241	F249	F260	F269	F274	F281	F290	F292	F312	F314	F315	F316	F324	F331	F344	F354	F358
F359	F364	F370	F371	F373	F381	F385	F442	F444	F469	F732	F735	F759	F077	F100	F101	F102	F309
F342	F343	F361	F362	F363	F365	F366	F078	F191	F325	F326	F720	F074	F082	F096	F097	F195	F724
F256	F079	F083	F084	F095	F099	F185	F190	F199	F233	F236	F238	F242	F283	F725	F730	F731	F736
F737																	

90° switching

F056	F063	F068	F134	F201	F251	F252	F346	F456	F058	F065	F069	F177	F178	F182	F208	F253	F254
F340	F360	F378	F458	F443	F700	F743	F057	F061	F064	F067	F171	F181	F205	F207	F209	F320	F349
F437	F445	F715	F719	F059	F060	F062	F066	F170	F172	F173	F174	F175	F176	F179	F180	F186	F188
F202	F204	F206	F250	F265	F266	F286	F318	F327	F338	F339	F425	F716	F717	F718	F726	F733	F751
F755	F756																

Miscellaneous

F119	F130	F122	F126	F125	F129	F225	F248	F246	F261	F341	F345	F287	F123	F127	F145	F146	F148						
F706	F707	F245	F120	F124	F128	F131	F121	F132	F749									F990	F991	F801	F802	F803	F804
F805	F806	F807	F808	F809	F810	F811	F812	F813	F814	F815	F816	F817	F818	F819	F820	F821	F822						
															2	<p>¹INTERRUPTEUR PRINCIPAL, OUVERTURE EN POSITION 0 ²INTERRUPTORE GENERALE, APRIRE SOLO CON MANIGLIA SU 0 ³INTERRUPTOR PRINCIPAL, ABRIR ARMARIO SOLO EN POS. "0"</p>							

Handles

Type	Color	Code	Size		
			S00	S0	S1

Type	Color	Code	Size		
			S00	S0	S1

	black	G001	—	●	●
	red	G002	—	●	●
	white	G003	—	●	●
	electro-gray	G007	—	●	●

	black	G251	●	●	●
	red	G252	●	●	●
	white	G253	●	●	●
	electro-gray	G257	●	●	●

	black	G221	●	●	●
	red	G222	●	●	●
	white	G223	●	●	●
	electro-gray	G227	●	●	●

	black	G521	—	●	●
	red	G522	—	●	●
	white	G523	—	●	●
	electro-gray	G527	—	●	●

	black	G301	—	●	●
	red	G302	—	●	●
	white	G303	—	●	●
	electro-gray	G307	—	●	●

	black	G501	—	—	●
	red	G502	—	—	●
	white	G503	—	—	●
	electro-gray	G507	—	—	●















	black	G211	—	●	●
	red	G212	—	●	●
	white	G213	—	●	●
	electro-gray	G217	—	●	●

	black	G411	—	—	●
	red	G412	—	—	●
	white	G413	—	—	●
	electro-gray	G417	—	—	●

	black	G321	—	—	●
	red	G322	—	—	●
	white	G323	—	—	●
	electro-gray	G327	—	—	●

--	--	--	--	--	--

International Standards and Approvals

Country	Authority	Mark or Standard					CH6		CHR6	
			CG4	CG4-1 CGD4-1	CG6	CG8	CH10 CH11 CH12 CH10B	CH16 CH16B	CHR10 CHR11 CHR12 CHR10B	CHR16 CHR16B
USA	Underwriters Laboratories	 ¹						●	●	
		 ² ³	●	●	●	●	●	●		
Canada	Canadian Standards Association	 ⁶	●	CG4-1	●	●	●	●	●	
		 ¹						●	●	
		 ² ³	●	●			●	●		
Switzerland	Schweizerischer Elektrotechnischer Verein		●	+	+	+	+	+	+	
Denmark	Danmarks Elektriske Materielkontrol		+	+	+	+	+	+	+	
Norway	Norges Elektriske Materielkontrol		+	+	+	+	+	+	+	
Sweden	Svenska Elektriska Materielkontrollanstalten		+	+	+	+	+	+	+	
Finland	Sähkötar-kastuskeskus		+	+	+	+	+	+	+	
Austria	Österreichischer Verband für Elektrotechnik		+	+	+	+	+	+	+	
Federal Republic of Germany	Verband Deutscher Elektrotechniker	VDE 0660 ⁴	+	+	+	+	+	+	+	
Great Britain	British Standards Institution	BS EN 60947 ⁴	+	+	+	+	+	+	+	
International Electrical Commission (IEC) Recommendation		IEC 60947 ⁵	+	+	+	+	+	+	+	
China	China Quality Certification Centre	 ⁷ GB14048.3	●	CG4-1			CH10 CH10B	●	CHR10 CHR10B	
Russian Federation	GOST	 ⁷ CH01	●	● +	●	●	●	●	●	
Germanischer Lloyd			+	+	+	+	+	+	+	
Lloyds Register EMEA			+	+	+	+	CH10 CH10B	●	+	

● Switch approved + Switch conforms to requirements

¹Approved under the "Component Program" (UL-Recognized Industrial Component). File No. E35541, Category Control No. NLRV2 (U.S.) resp. NLRV8 (Canada).

²Approved under the "Listing Program". File No. E35541, Category Control No. NLRV (U.S.) resp. NLRV7 (Canada).

³Switch types CGD4-1, CH11, CH12, CHR11, CHR12 approved under the "Listing Program". File No. E60262, Category Control No. NRNT (U.S.) resp. NRNT7 (Canada).

⁴It is not required for Industrial Switchgear to bear a symbol but must conform to requirements. By stating the specific standard no. on the product the manufacturer declares that all requirements of the product standard are met.

⁵IEC does not operate an approval scheme.

⁶File No. 13002, Class No. 3211-05 resp. 4652-04.

⁷If this approval is required, please request when ordering.

Selection Data	CG4	CG6	CH6	CHR6		
	CG4-1	CG8	CH10 CH10B	CHR10 CHR10B	CH16 CH16B	CHR16 CHR16B

Rated Insulation Voltage U_e	IEC 60947-3, EN 60947-3 ¹ VDE 0660 part 107 ¹	V	440	690	690	690	690	690		
	SEV max.	V	400	690	–	–	–	–		
	UL/Canada ²	V	300	300	600	600	600	600		
	CEE 24	V	380	380	–	–	–	–		
	min. voltage	V			on request					
Rated Impulse Withstand Voltage U_{imp}¹		kV	4	6	6	6	6	6		
Rated Thermal Current I_U/I_{th}	IEC 60947-3, EN 60947-3 VDE 0660 part 107	A	10	20	20	20	25	25		
	SEV max.	A	10	20	–	–	–	–		
	UL/Canada	A	10	16	20	20	25	25		
Rated Operational Current I_e	AC-21A Switching of resistive loads, including moderate overloads	IEC 60947-3, EN 60947-3 VDE 0660 part 107	A	10	20	20	20	25	25	
	AC-1 Resistive or low inductive loads	SEV	400 V	A	10	–	–	–	–	–
			500 V	A	–	–	–	–	–	–
			600 V	A	–	–	–	–	–	–
	AC-22A Switching of combined resistive or low inductive loads including moderate overloads	IEC 60947-3 VDE 0660, part 107	220 V-440 V	A	10	20	20	20	25	25
			500 V	A	–	20	20	20	25	25
			660 V-690 V	A	–	16	16	16	25	25
	AC-15 Switching of control devices, contactors, valves etc.	IEC 60947-3 VDE 0660, part 107	110 V	A	2,5	6	5	5	8	8
			220 V-240 V	A	2,5	5	5	5	8	8
			380 V-440 V	A	1,5	4	4	4	5	5
Pilot Duty	UL/Canada ²	Heavy		A300	A300	A600	A600	A600	A600	
Ampere Rating Resistive or low inductive loads	UL/Canada ²		A	10	16 (150 V) 10 (300 V)	20	20	25	25	
Resistive load/Motor load	CEE 24 ² NEMKO/FI ²		A	4/2 6/4 ⁴	10/6	–	–	–	–	
Breaking capacity	220 V-240 V 380 V-440 V 660 V-690 V	A	50	150	150	150	200	200		
		A	50	150	150	150	200	200		
		A	–	80	80	80	125	125		
Power loss per contact at I_U Resistance to vibration Resistance to shock		W	0,4/0,7	0,8	1,4 on request min. 5 g, 30 ms	1,4	2,3	2,3		
Short Circuit Protection	Max. fuse size (gL-characteristic) Rated short-time withstand current (1s-current)	A	10	25	25	25	35	35		
		A	90	140	200	200	250	250		
DC Switching Capacity⁶			Rated Operational Current I_e							
No. of series contacts	1 2 3 4 5 6 8		CG4 CG4-1	CG6 CG8	CG8S ³	CH6 CH10 CH10B	CHR6 CHR10 CHR10B	CH16 CH16B	CHR16 CHR16B	
Resistive loads $T \leq 1$ ms	24 48 70 95 120 145 190	A	10	20	20	20	20	25	25	
	48 95 140 190 240 290 350		6	12	16	12	12	20	20	
	60 120 180 240 300 360 450		2,5	4,5	8	4,5	4,5	7,5	7,5	
	110 220 330 440 550 660 –		0,7	1	2	1	1	1,5	1,5	
	220 440 660 – – – –		0,3	0,4	0,6	0,4	0,4	0,5	0,5	
440 660 – – – –	0,2	0,27	0,35	0,27	0,27	0,3	0,3			
Inductive loads $T = 50$ ms	24 48 70 95 120 145 190	A	6	12	20	12	12	20	20	
	30 60 90 120 150 180 240		3	5	13	5	5	9	9	
	48 95 140 190 240 290 350		1	2	6	2	2	3	3	
	60 120 180 240 300 360 450		0,7	1	3	1	1	1,5	1,5	
	110 220 330 440 550 660 –		0,3	0,4	1	0,4	0,4	0,5	0,5	
Ambient Temperature of Stages^{5,7}	open at 100 % I_U/I_{th} enclosed at 100 % I_{the}		55 °C during 24 hours with peaks up to 60 °C 35 °C during 24 hours with peaks up to 40 °C							

¹Valid for lines with grounded common neutral termination, overvoltage category III, pollution degree 3. Values for other supply systems on request. ²International Standards and Approvals, refer to page 33. ³Valid only for max. 4 simultaneously opening contacts. ⁴Valid for CG4 only. ⁵For electromagnetic optional extras see additional data in Catalog 101. ⁶Values for switches with spring return on request. ⁷Storage temperature: -40 °C to 85 °C (in case of temperature below -5 °C no shock load permissible).

Selection Data	CG4	CG6	CH6	CHR6	CH16	CHR16
	CG4-1	CG8	CH10 CH10B	CHR10 CHR10B	CH16B	CHR16B

Rated Utilization Category		IEC 60947-3, EN 60947-3 VDE 0660 part 107								
AC-2	Slip ring motor starting, reversing and plugging, star-delta starting (CG4-CHR10B)	3 phase	220 V-240 V	kW	2,5	4	4	4	5,5	5,5
		3 pole	380 V-440 V		4,5	7,5	7,5	7,5	11	11
			500 V		–	10	10	10	15	15
			660 V-690 V		–	10	10	10	13	13
AC-3	Direct-on-line starting, star-delta starting (CH16-CHR16B)	3 phase	220 V-240 V	kW	1,5	3	3	3	4	4
		3 pole	380 V-440 V		2,2	5,5	5,5	5,5	7,5	7,5
			500 V		–	5,5	5,5	5,5	7,5	7,5
			660 V-690 V		–	5,5	5,5	5,5	7,5	7,5
		1 phase	110 V-120 V	kW	0,3	0,6	0,6	0,6	1,5	1,5
	2 pole	220 V-240 V	0,55		2,2	2,2	2,2	3	3	
		380 V-440 V	0,75		3	3	3	3,7	3,7	
		500 V	–		–	3	3	4	4	
		660 V-690 V	–	–	3	3	3,7	3,7		
AC-4	Direct-on-line starting, reversing, plugging and inching	3 phase	220 V-240 V	kW	0,37	0,55	0,55	0,55	1,5	1,5
		3 pole	380 V-440 V		0,55	1,5	1,5	1,5	3	3
			500 V		–	1,5	1,5	1,5	3	3
			660 V-690 V	–	1,5	1,5	1,5	3	3	
		1 phase	110 V-120 V	kW	0,15	0,3	0,3	0,3	0,45	0,45
	2 pole	220 V-240 V	0,25		0,75	0,75	0,75	1,1	1,1	
		380 V-440 V	0,5	1,5	1,5	1,5	2,2	2,2		
AC-23A	Frequent switching of motors or other high inductive loads	3 phase	220 V-240 V	kW	1,8	3,7	3,7	3,7	5,5	5,5
		3 pole	380 V-440 V		3	7,5	7,5	7,5	11	11
			500 V		–	7,5	7,5	7,5	11	11
			660 V-690 V		–	7,5	7,5	7,5	11	11
		1 phase	110 V-120 V	kW	0,37	0,75	0,75	0,75	1,5	1,5
	2 pole	220 V-240 V	0,75		2,5	2,5	2,5	3	3	
		380 V-440 V	1,1		3,7	3,7	3,7	5,5	5,5	
		500 V	–		–	4	4	5,5	5,5	
		660 V-690 V	–	–	4	4	5,5	5,5		
Ratings		UL/Canada								
Standard motor load DOL-Rating (similar AC-3)	3 phase	110 V-120 V	HP	0,75	1,5	1,5	1,5	2	2	
	3 pole	220 V-240 V		1	1	3	3	5	5	
		440 V-600 V		–	–	5	5	10	10	
	1 phase	110 V-120 V	HP	0,33	0,5	0,5	0,5	1	1	
2 pole	220 V-240 V	0,75		1	1	1	2	2		
	277 V	0,75		1	2	2	3	3		
	440 V-600 V	–		–	2	2	5	5		
Heavy motor load Reversing-Rating (similar AC-4)	3 phase	110 V-120 V	HP	–	0,5	0,5	0,5	1	1	
	3 pole	220 V-240 V		–	1	1	1	2	2	
		440 V-600 V		–	–	3	3	5	5	
		1 phase		110 V-120 V	HP	–	0,17	0,17	0,17	0,33
2 pole	220 V-240 V	–	0,5	0,5		0,5	0,75	0,75		
	277 V	–	0,5	0,6		0,6	1	1		
		440 V-600 V	–	–	1,5	1,5	2	2		
Max. Permissible Wire Gage - Use copper wire only										
Single-core or stranded wire				mm ²	2x1,5	2x2,5	2x4		2x4	
				AWG	2x14	2x12	2x10		2x10	
Flexible wire (sleeving in accordance with DIN 46228)				mm ²	2x1,5(1)	2x2,5(2,5)	2x2,5(2,5)		2x2,5(2,5)	
Flexible AWG wires (without sleeve)				AWG	2x16	2x14	2x12		2x12	
Connection with insulated ring and fork type terminals										
Internal diameter				mm				≥3,6		≥3,6
External diameter				mm				≤8,6		≤8,6
Connection with quick connect terminations				mm				6,3		6,3

Selection Data	CGD4-1	CH11	CHR11	CH12	CHR12
-----------------------	--------	------	-------	------	-------

Rated Insulation Voltage U_e		IEC 60947-3, EN 60947-3 ¹ VDE 0660 part 107 ¹	V	440	600	600	600	600	
North America			V	300	300	300	300	300	
min. voltage			V	1 ⁴	1 ⁴	1 ⁴	6	6	
Rated Impulse Withstand Voltage U_{imp}				on request					
Rated Thermal Current I_U/I_{th}		IEC 60947-3, EN 60947-3 VDE 0660 part 107	A	5	6	6	6	6	
North America			A	5	6	6	6	6	
Rated Operational Current I_e		IEC 60947-3, EN 60947-3 VDE 0660 part 107							
AC-21A	Switching of resistive loads, including moderate overloads	North America ²	1 V/6 V	A	5/2	6/3	6/3	-/6	-/6
			12 V/24 V	A	1,2/0,7	2/1	2/1	6/5	6/5
			48 V/60 V	A	0,45/-	0,8/0,7	0,8/0,7	4/3,5	4/3,5
			110 V	A	0,25	0,4	0,4	3	3
			240 V	A	0,15	0,2	0,2	1,8	1,8
			300 V	A	0,13	0,13	0,13	1,3	1,3
			440 V	A	0,1	0,1	0,1	1	1
			500 V	A	-	0,08	0,08	0,8	0,8
			600 V	A	-	0,05	0,05	0,5	0,5
Power loss per contact at I_u			W	0,4	0,4	0,4	0,2	0,2	
Short Circuit Protection									
Max. fuse size		(glass-tube, quick)	A	5	6	6	6	6	
Rated short-time withstand current		(1s-current)	A	30	35	35	50	50	
DC Switching Capacity⁵		IEC 60947-3, EN 60947-3 VDE 0660 part 107							
DC-21B	Resistive load $T \leq 1$ ms	North America ²	1 V/6 V	A	3/1,2	4/2,5	4/2,5	-/4	-/4
			12 V/24 V	A	0,7/0,4	1,5/0,8	1,5/0,8	3/2,2	3/2,2
			48 V/60 V	A	0,25/0,2	0,3/0,27	0,3/0,27	1,2/1	1,2/1
			110 V/240 V	A	0,13/0,08	0,2/0,1	0,2/0,1	0,6/0,3	0,6/0,3
			300 V/440 V	A	0,07/0,05	0,07/0,05	0,07/0,05	0,2/0,15	0,2/0,15
			500 V/600 V	A	-	0,03/0,02	0,03/0,02	0,1/0,1	0,1/0,1
Max. Permissible Wire Gage - Use copper wire only									
Single-core or stranded wire			mm ²	2x1,5	2x4		2x4		
			AWG	2x14	2x10		2x10		
Flexible wire (sleeving in accordance with DIN 46228)			mm ²	2x1,5(1)	2x2,5(2,5)		2x2,5(2,5)		
Flexible AWG wires (without sleeve)			AWG	2x16	2x12		2x12		
Connection with insulated ring and fork type terminals			mm						
Internal diameter			mm			≥3,6		≥3,6	
External diameter			mm			≤8,6		≤8,6	
Connection with quick connect terminations			mm			6,3		6,3	
Ambient Temperature of Stages^{3, 6}		open at 100 % I_U/I_{th} enclosed at 100 % I_{the}		55 °C during 24 hours with peaks up to 60 °C 35 °C during 24 hours with peaks up to 40 °C					

¹Valid for lines with grounded common neutral termination, overvoltage category III, pollution degree 3. Values for other supply systems on request.
²max. 300 V. ³For electromagnetic optional extras see additional data in Catalog 101. ⁴Values for lower voltages on request. ⁵Values for switches with spring return on request. ⁶Storage temperature: -40 °C to 85 °C (in case of temperature below -5 °C no shock load permissible).

Two or Four Hole Panel Mounting

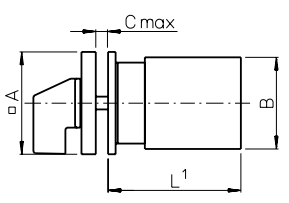
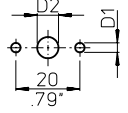
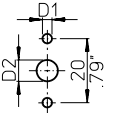
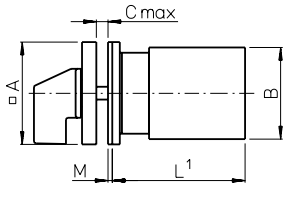
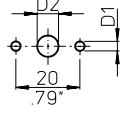
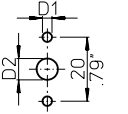
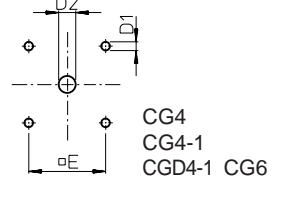
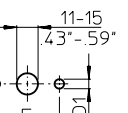
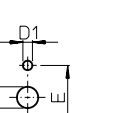
 <p>E for CG4-CGD4-1 CH6/CHR6 E-V for CG6</p>  <p>E-V for CG4-CGD4-1 CH6/CHR6 E for CG6</p> 	 <p>EF for CG4-CGD4-1 CH6/CHR6 EF-V for CG6</p>  <p>EF-V for CG4-CGD4-1 CH6/CHR6 EF for CG6</p> 	 <p>E22 for CG E22-V for CH/CHR</p>  <p>E22-V for CG E22 for CH/CHR</p> 																																																																																																																											
<table border="1"> <thead> <tr> <th></th> <th>CG4 CG4-1 CGD4-1</th> <th>CG6</th> <th>CG8</th> <th>CH6 CHR6</th> <th>CH10- CHR16</th> <th>CH10B- CHR16B</th> </tr> </thead> <tbody> <tr> <td>A</td> <td>30 1.18</td> <td>30 1.18</td> <td>48 1.89</td> <td>30 1.18</td> <td>48 1.89</td> <td>64 2.52</td> </tr> <tr> <td>B</td> <td>28 1.10</td> <td>38 1.50</td> <td>38 1.50</td> <td>46 1.81</td> <td>46 1.81</td> <td>56 2.20</td> </tr> <tr> <td>C</td> <td>4 .16</td> <td>4 .16</td> <td>4 .16</td> <td>4 .16</td> <td>4 .16</td> <td>4 .16</td> </tr> <tr> <td>D1</td> <td>3.2 .13</td> <td>3.2 .13</td> <td>5 .20</td> <td>3.2 .13</td> <td>5 .20</td> <td>5 .20</td> </tr> <tr> <td>D2</td> <td>8-11 .31-.43</td> <td>8-11 .31-.43</td> <td>8-15 .31-.59</td> <td>8-11 .31-.43</td> <td>8-15 .31-.59</td> <td>10-15 .39-.59</td> </tr> <tr> <td>E</td> <td>-</td> <td>-</td> <td>36 1.42</td> <td>-</td> <td>36 1.42</td> <td>48 1.89</td> </tr> </tbody> </table>		CG4 CG4-1 CGD4-1	CG6	CG8	CH6 CHR6	CH10- CHR16	CH10B- CHR16B	A	30 1.18	30 1.18	48 1.89	30 1.18	48 1.89	64 2.52	B	28 1.10	38 1.50	38 1.50	46 1.81	46 1.81	56 2.20	C	4 .16	4 .16	4 .16	4 .16	4 .16	4 .16	D1	3.2 .13	3.2 .13	5 .20	3.2 .13	5 .20	5 .20	D2	8-11 .31-.43	8-11 .31-.43	8-15 .31-.59	8-11 .31-.43	8-15 .31-.59	10-15 .39-.59	E	-	-	36 1.42	-	36 1.42	48 1.89	<table border="1"> <thead> <tr> <th></th> <th>CG4 CG4-1 CGD4-1</th> <th>CG6</th> <th>CG8</th> <th>CH6 CHR6</th> <th>CH10- CHR16</th> <th>CH10B- CHR16B</th> </tr> </thead> <tbody> <tr> <td>A</td> <td>30 1.18</td> <td>30 1.18</td> <td>48 1.89</td> <td>30 1.18</td> <td>48 1.89</td> <td>64 2.52</td> </tr> <tr> <td>B</td> <td>28 1.10</td> <td>38 1.50</td> <td>38 1.50</td> <td>46 1.81</td> <td>46 1.81</td> <td>56 2.20</td> </tr> <tr> <td>C</td> <td>4 .16</td> <td>4 .16</td> <td>4 .16</td> <td>4 .16</td> <td>4 .16</td> <td>4 .16</td> </tr> <tr> <td>D1</td> <td>3.2 .13</td> <td>3.2 .13</td> <td>5 .20</td> <td>3.2 .13</td> <td>5 .20</td> <td>5 .20</td> </tr> <tr> <td>D2</td> <td>8-11 .31-.43</td> <td>8-11 .31-.43</td> <td>15-19 .59-.75</td> <td>8-11 .31-.43</td> <td>15-19 .59-.75</td> <td>19-22 .75-.87</td> </tr> <tr> <td>E</td> <td>-</td> <td>-</td> <td>36 1.42</td> <td>-</td> <td>36 1.42</td> <td>48 1.89</td> </tr> <tr> <td>M</td> <td>1 .04</td> <td>1 .04</td> <td>-</td> <td>1 .04</td> <td>-</td> <td>-</td> </tr> </tbody> </table>		CG4 CG4-1 CGD4-1	CG6	CG8	CH6 CHR6	CH10- CHR16	CH10B- CHR16B	A	30 1.18	30 1.18	48 1.89	30 1.18	48 1.89	64 2.52	B	28 1.10	38 1.50	38 1.50	46 1.81	46 1.81	56 2.20	C	4 .16	4 .16	4 .16	4 .16	4 .16	4 .16	D1	3.2 .13	3.2 .13	5 .20	3.2 .13	5 .20	5 .20	D2	8-11 .31-.43	8-11 .31-.43	15-19 .59-.75	8-11 .31-.43	15-19 .59-.75	19-22 .75-.87	E	-	-	36 1.42	-	36 1.42	48 1.89	M	1 .04	1 .04	-	1 .04	-	-	<table border="1"> <thead> <tr> <th></th> <th>CG8</th> <th>CH10- CHR16</th> </tr> </thead> <tbody> <tr> <td>A</td> <td>48 1.89</td> <td>48 1.89</td> </tr> <tr> <td>B</td> <td>38 1.50</td> <td>46 1.81</td> </tr> <tr> <td>C</td> <td>4 .16</td> <td>4 .16</td> </tr> <tr> <td>D1</td> <td>5 .20</td> <td>5 .20</td> </tr> <tr> <td>E</td> <td>30 1.17</td> <td>30 1.17</td> </tr> </tbody> </table>		CG8	CH10- CHR16	A	48 1.89	48 1.89	B	38 1.50	46 1.81	C	4 .16	4 .16	D1	5 .20	5 .20	E	30 1.17	30 1.17
	CG4 CG4-1 CGD4-1	CG6	CG8	CH6 CHR6	CH10- CHR16	CH10B- CHR16B																																																																																																																							
A	30 1.18	30 1.18	48 1.89	30 1.18	48 1.89	64 2.52																																																																																																																							
B	28 1.10	38 1.50	38 1.50	46 1.81	46 1.81	56 2.20																																																																																																																							
C	4 .16	4 .16	4 .16	4 .16	4 .16	4 .16																																																																																																																							
D1	3.2 .13	3.2 .13	5 .20	3.2 .13	5 .20	5 .20																																																																																																																							
D2	8-11 .31-.43	8-11 .31-.43	8-15 .31-.59	8-11 .31-.43	8-15 .31-.59	10-15 .39-.59																																																																																																																							
E	-	-	36 1.42	-	36 1.42	48 1.89																																																																																																																							
	CG4 CG4-1 CGD4-1	CG6	CG8	CH6 CHR6	CH10- CHR16	CH10B- CHR16B																																																																																																																							
A	30 1.18	30 1.18	48 1.89	30 1.18	48 1.89	64 2.52																																																																																																																							
B	28 1.10	38 1.50	38 1.50	46 1.81	46 1.81	56 2.20																																																																																																																							
C	4 .16	4 .16	4 .16	4 .16	4 .16	4 .16																																																																																																																							
D1	3.2 .13	3.2 .13	5 .20	3.2 .13	5 .20	5 .20																																																																																																																							
D2	8-11 .31-.43	8-11 .31-.43	15-19 .59-.75	8-11 .31-.43	15-19 .59-.75	19-22 .75-.87																																																																																																																							
E	-	-	36 1.42	-	36 1.42	48 1.89																																																																																																																							
M	1 .04	1 .04	-	1 .04	-	-																																																																																																																							
	CG8	CH10- CHR16																																																																																																																											
A	48 1.89	48 1.89																																																																																																																											
B	38 1.50	46 1.81																																																																																																																											
C	4 .16	4 .16																																																																																																																											
D1	5 .20	5 .20																																																																																																																											
E	30 1.17	30 1.17																																																																																																																											

¹see page 43

Four Hole Panel Mounting or Mosaic Mounting

EG
EGF

	CG8	CH10-CHR16
A	64 2.52	64 2.52
B	38 1.50	46 1.81
C	4 .16	4 .16
D1	5 .20	5 .20
D2	10-15 .39-.59	10-15 .39-.59
E	48 1.89	48 1.89
M	6,7 .26	6,7 .26

E9
E91

for CG4-CGD4-1
CH6/CHR6

for CG6

E92

	CG4 CG4-1 CGD4-1	CG6	CH6 CHR6
B	28 1.10	38 1.50	46 1.81

E93
E94

	CG4 CG4-1 CGD4-1	CG6 CH6 CHR6	E9	E91	E92	E93	E94
D	6 .24	6,35 .25	-	-	-	-	-
F	12 .47	12,8 .50	-	-	-	-	-
G	15,4 .61	17,4 .69	32,5 1,28	28,5 1,12	32,5 1,28	-	-
K	4,7 .19	5,5 .22	-	-	-	-	-
M	-	-	-	4 .16	-	-	-

Two or Four Hole Panel Mounting

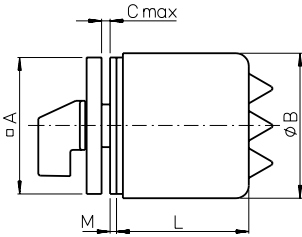

**EC
ED
EC1
ED1**

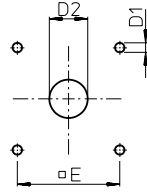

ED22

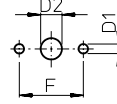

		CH10-CHR16		CH10B-CHR16B		
		ED22	EC ED	ED22	EC ED	EC1 ED1
A		48	64	48	64	64
		1.89	2.52	1.89	2.52	2.52
B		74	68	74	68	74
		2.91	2.68	2.91	2.68	2.91
EC/EC1	C	-	4	-	4	4
		-	.16	-	.16	.16
ED/ED1/ED22	C	4	2	4	4	4
		.16	.08	.16	.16	.16
D1		5	5	5	5	5
		.20	.20	.20	.20	.20
EC/EC1	D2	-	8-15	-	10-15	10-15
		-	.31-.59	-	.39-.59	.39-.59
ED/ED1/ED22	D2	11-15	18-22	11-15	22-25	19-22
		.43-.59	.71-.87	.43-.59	.87-.98	.75-.87
E		-	48	-	48	48
		-	1.89	-	1.89	1.89
F		30	-	30	-	-
		1.17	-	1.17	-	-
ED/ED1/ED22	M	1.5	2	1.5	2	-
		.06	.08	.06	.08	-
Stages L	1	74,3	-	74,3	-	72,7
		2.93	-	2.93	-	2.86
2		74,3	-	74,3	-	72,7
		2.93	-	2.93	-	2.86
3		94,3	-	94,3	-	92,7
		3.71	-	3.71	-	3.65
4		94,3	103	94,3	114,5	-
		3.71	4.06	3.71	4.51	-
5		94,3	-	-	127	-
		3.71	-	-	5.00	-
6		-	-	-	139,5	-
		-	-	-	5.49	-
7		-	-	-	164,5	-
		-	-	-	6.48	-
8		-	-	-	177	-
		-	-	-	6.97	-
9		-	-	-	-	-
		-	-	-	-	-
10		-	-	-	-	-
		-	-	-	-	-

Four Hole Panel Mounting or Single Hole Mounting

**KN1
KD1
KN2**

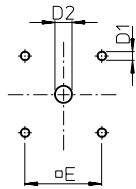
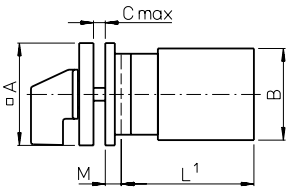

	KN2			KN1 KD1	
	CG8	CH10- CHR16		CG8	CH10- CHR16
A	48 1.89	48 1.89	A	64 2.52	64 2.52
B	38 1.50	46 1.81	B	38 1.50	46 1.81
C	4 .16	4 .16	C	4 .16	4 .16
D1	5 .20	5 .20	D1	5 .20	5 .20
D2	8-15 .31-.59	8-15 .31-.59	D2	10-15 .39-.59	10-15 .39-.59
E	36 1.42	36 1.42	E	48 1.89	48 1.89
M	5,2 .20	5,2 .20	M	4,7 .19	7 .28

**FS1...
FT1...
FT3...**

**FH3...
FS2...
FT2...
FT4...**

**FH4...
FS4...
FT6...**

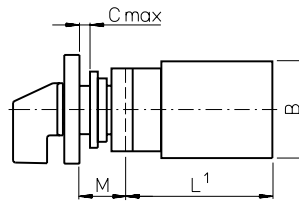
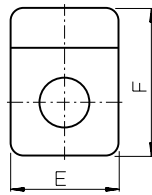
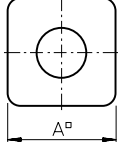
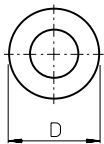

**FS1...
FS2...
FS4...**

**FH3...
FH4...
FT1...
FT2...
FT6...**

**FT3...
FT4...**

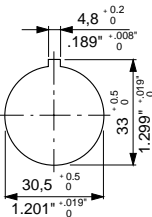
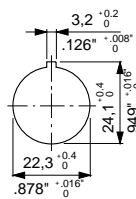
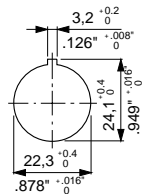
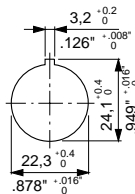
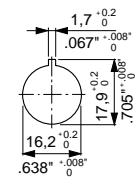

	CG4			CH6 CHR6	CH10- CHR16
	CG4-1 CGD4-1	CG6	CG8		
A/E	30 1.18	30 1.18	48 1.89	30 1.18	48 1.89
FH3...	-	-	64	-	64
FH4...	-	-	2.52	-	2.52
B	28 1.10	38 1.50	38 1.50	46 1.81	46 1.81
C	5 .20	5 .20	6 .24	5 .20	6 .24
D	29,5 1.16	29,5 1.16	39 1.54	29,5 1.16	39 1.54
F	39 1.54	39 1.54	59 2.32	39 1.54	59 2.32
FH4...	-	-	78,5 3.09	-	78,5 3.09
M	12,5 .49	12,5 .49	18,2 .72	12,5 .49	18,2 .72
FH3...	-	-	25,2 .99	-	25,2 .99
FH4...	-	-	25,2 .99	-	25,2 .99

Base Mounting

**VE
VE-V**

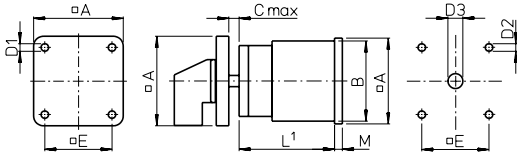

**VF
VF-V**

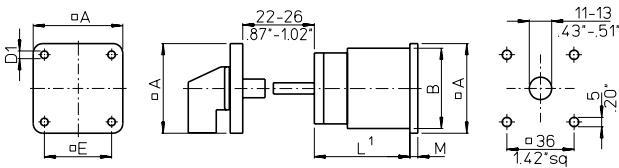

**VE22
VE22V**

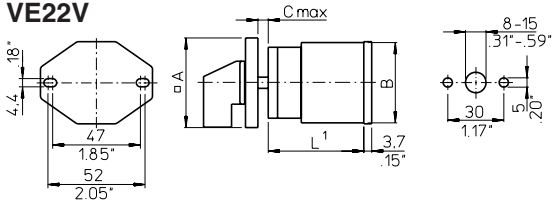

**VF22
VF22V**

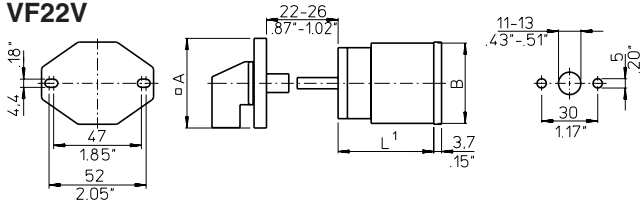

	CG8	CH10- CHR16
A²	48 1.89	48 (64) 1.89 (2.52)
B	38 1.50	46 1.81
C	10,5 .41	10,5 .41
D1	4,1 .16	4,1 .16
D2	5 .20	5 .20
D3	8-15 .31-.59	8-15 .31-.59
E²	36 1.42	36 (48) 1.42 (1.89)
M	2,2 .09	5,2 .20

²Dimensions in () for revertive mounting plate

VE1

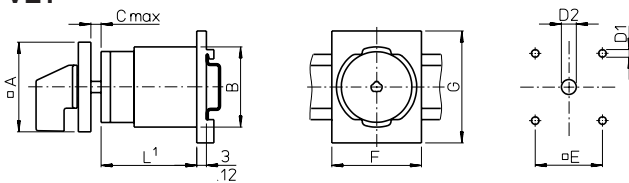

VE1E

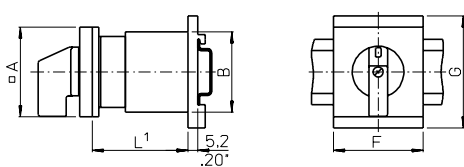

VE1F

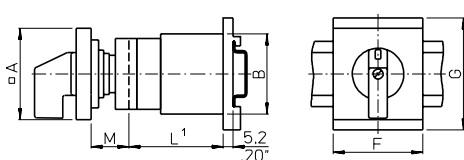

	CG4 CG4-1 CGD4-1	CG8	CH10- CHR16
A	30 1.18	48 1.89	48 1.89
B	28 1.10	38 1.50	46 1.81
C	-	10,5 .41	10,5 .41
D1	-	5 .20	5 .20
D2	-	8-15 .31-.59	8-15 .31-.59
E	-	36 1.42	36 1.42
F	35,5 1.40	48 1.89	48 1.89
G	60 2.36	60 2.36	60 2.36
M	12,5 .49	20 .79	20 .79

¹see page 43

Base Mounting and Escutcheon Plates

VE2

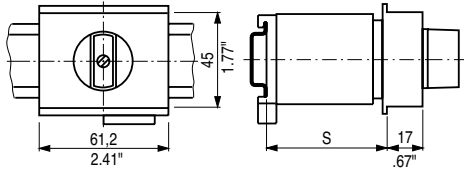

VE21

for CG4-CGD4-1

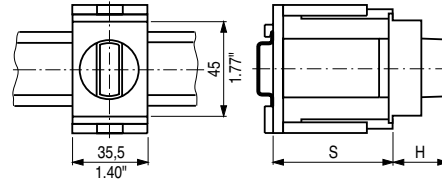

VE3

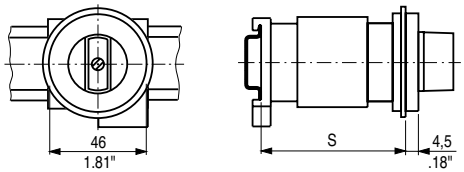

VE21

for CG8-CHR16

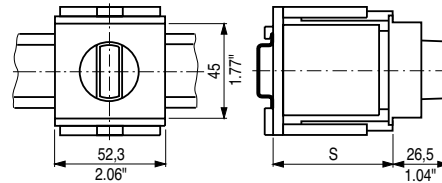

VE4

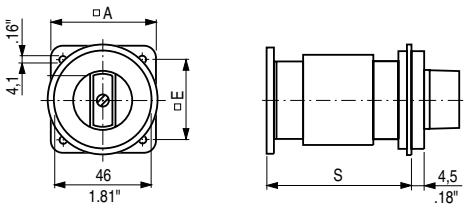

	VE2		VE3		VE4	
	CG8	CH10-CHR16	CG8	CH10-CHR16	CG8	CH10-CHR16
	Max. no. of stages		Max. no. of stages		Max. no. of stages	
S = 46 1.81	1	1	-	-	1	-
S = 50 1.97	2	2	1	1	1	-
S = 61 2.40	3	2	2	1	2	1
S = 67 2.64	3	3	2	2	2	2
S = 69 2.70	3	3	2	2	2	2
A					48 1.89	64 2.52
E					36 1.42	48 1.89

VE21

S_{min.}	H	No. of stages		
		CG4-CGD4-1	CG8	CH10-CHR16
44 1.73	21 .83	1	1	1
46 1.81	26.5 1.04	2	2	-
50 1.97	-	-	-	2
54 2.13	-	-	-	-
60 2.36	-	-	3	-
62 2.44	26.5 1.04	3	-	-
64 2.52	-	-	-	3
72 2.83	-	-	4	-

Escutcheon plates for mounting E, EF, EG, EGF, KN1, KD1, KN2, EC, EC1, ED, ED1, VE, VE1, VF

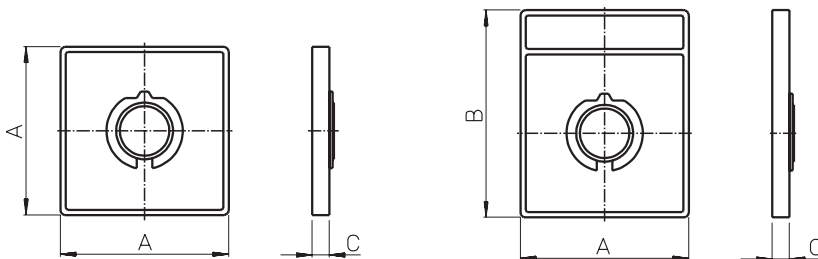

Size	A	B	C
S00	30 1.18	39 1.54	5.5 .22
S0	48 1.89	59 2.32	6.7 .26
S1	64 2.52	78 3.07	7.4 .29

Additional Lengths

Additional lengths for amendment (page 4)

	CG8	CH10 CH16	CHR10 CHR16
B	6,2 .24	6,2 .24	6,2 .24
S	17,3 .68	17,3 .68	17,3 .68
L, M	24,8 .98	24,8 .98	24,8 .98
X	23,3 .92	23,3 .92	23,3 .92

Quick connect terminations (plug 2,8 mm or 6,35 mm) for CH switches (page 4)

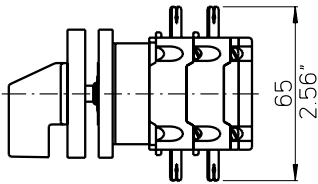

with quick connects

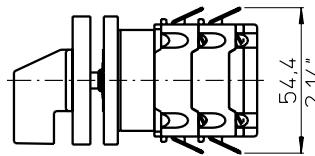

with angled quick connects

Length L

Stages	CG4			CH6 CHR6	CH10 CH11		CHR10 CHR11	
	CG4-1		CG8		CH12	CH10B	CHR12	CHR10B
	CGD4-1	CG6			CH16	CH16B	CHR16	CHR16B
1	38,5 1.52	43,2 1.70	40,7 1.60	46 1.81	43,5 1.71	43,5 1.71	48,9 1.93	48,9 1.93
2	50,5 1.99	55,9 2.20	53,4 2.10	60 2.36	57,5 2.26	57,5 2.26	62,9 2.48	62,9 2.48
3	62,5 2.46	68,6 2.70	66,1 2.60	74 2.91	71,5 2.81	71,5 2.81	76,9 3.03	76,9 3.03
4	74,5 2.93	81,3 3.20	78,8 3.10	88 3.46	85,5 3.37	85,5 3.37	90,9 3.58	90,9 3.58
5	86,5 3.41	-	91,5 3.60	-	99,5 3.92	99,5 3.92	104,9 4.13	104,9 4.13
6	98,5 3.88	-	104,2 4.10	-	113,5 4.47	113,5 4.47	118,9 4.68	118,9 4.68
7	110,5 4.35	-	116,9 4.60	-	127,5 5.02	127,5 5.02	132,9 5.23	132,9 5.23
8	122,5 4.82	-	129,6 5.10	-	141,5 5.57	141,5 5.57	146,9 5.78	146,9 5.78
9	-	-	142,3 5.60	-	155,5 6.12	155,5 6.12	160,9 6.34	160,9 6.34
10	-	-	155 6.10	-	169,5 6.67	169,5 6.67	174,9 6.89	174,9 6.89
11	-	-	167,7 6.60	-	183,5 7.22	183,5 7.22	188,9 7.44	188,9 7.44
12	-	-	180,4 7.10	-	197,5 7.77	197,5 7.77	202,9 7.99	202,9 7.99

The Range of “Blue Line” Switchgear

Technical literature covering the following products is available on request.

	Catalog Number
Main Switches and Main Switches with Emergency Function 16 A-315 A Maintenance Switches 20 A-315 A Switch Disconnectors 20 A-315 A According to IEC 60947-3, EN 60947-3, VDE 0660 part 107, IEC 60204, EN 60204 and VDE 0113	500
CL Switches 10 A-20 A C, CA and CAD Switches 10 A-315 A and L Switches 350 A-2400 A C, CA and CAD switches are designed for universal application. They are recommended for instrument, isolator, double-throw and motor control. L switches are designed for load and off-load applications. They are used to switch resistive or low inductive loads.	100
Optional Extras and Enclosures The complete product line, a large number of optional extras is available, including door interlocks, push-pull devices, cylinder and padlock attachments, control and indicator devices, AC motor drives, as well as enclosures, both insulated and metal.	101
A and AD Switches 6 A-25 A A and AD switches have 4 contacts in each switching stage. These switches provide an extensive range of switch functions and require a minimum mounting depth. Up to 24 switching positions are possible, with availability of 48 contacts per 12 stage switch column.	110
CG, CH and CHR Switches 10 A-25 A Ultra compact CG, CH and CHR switches are ideally suited for control and instrumentation applications. Switch terminals are “finger-proof” and conveniently accessible for wiring and are delivered open. All CG4 switches offer specially designed gold plated contacts or H-bridges with “cross-wire” contact systems, which facilitates their use in electronic circuitry and chemically aggressive environments.	120
DH, DHR, DK and DKR Switches 6 A-16 A DH, DHR, DK and DKR switches incorporate unique corrosion resistant contacts that permit operation on system voltage as low as 1 V. They have fully enclosed and protected contacts which can be operated either by rotary and/or lateral handle movement. D switches are used in calibration and semiconductor circuits. They are also used for relay and contactor control.	130
X Switches 200 A-630 A X switches can be applied for load, tap and gang switching duties. They incorporate 6 contacts in each switching stage. Their compact design provides a minimum length dimension for mounting purposes.	140
KG Switches 20 A-315 A and KH and KHR Switches 16 A-80 A KG, KH and KHR switches are excellent circuit interruptors. They have high through fault and fault making capacities and are especially designed for use as isolators and safety switches for machine tools, distribution panels and switchboards. KG ON/OFF switches offer unusually high dimensioned air and creepage distances between terminals which are designed for time saving “straight-line” wiring. ON/OFF switches are available with up to 8 poles and double-throw switches are available with up to 4 poles.	150
Contactors 16 A-115 A and Motor Starters 1,1 kW-55 kW These include control relays, motor contactors, two and four pole output contactors, heating contactors, thermal overload relays.	200
Push Buttons and Pilot Lights, 22,5 mm Ø A complete range of state-of-the-art push buttons and pilot lights represent an ideal combination of functional security and economical efficiency in a modular design.	302

Australia

Kraus & Naimer Pty. Ltd.
379 Liverpool Road, ASHFIELD, N.S.W. 2131
Tel: +61 2 9797-7333, Fax: 0092
salesaus@krausnaimer.com

Austria

Kraus & Naimer GmbH
Schumanngasse 35, Postfach 431
A-1181 WIEN
Tel: +43 1 404 06-0, Fax: 404 06-190
aso@krausnaimer.com

Belgium, Luxembourg

Kraus & Naimer B.V.
Ikaros Business Park
Ikaroslaan 2
B-1930 ZAVENTHEM
Tel: +32 2 757-0141, Fax: 1640
sales.be@krausnaimer.com

Brazil

Central and South America
Kraus & Naimer Ind. Com. Ltda.
Rua Santa Monica, 1061
Parque Industrial San Jose
06715-865 Cotia - SP
Tel: +55 11 2198-1288, Fax: 1251
knbrasil@krausnaimer.com.br

Canada

Kraus & Naimer Ltd.
219 Connie Crescent, Unit: 13A
CONCORD, Ontario, L4K 1L4
Tel: +1 905 738-1666, Fax: 9327
salescan@krausnaimer.com

Cyprus

ELECTROMATIC CONSTRUCTIONS LTD.
72, Evagoras Pallikarides Str., CY-2235 LATSIA-Nicosia
P. O. Box 12630, CY-2251 LATSIA-Nicosia
Tel: +357 2 48 41 41, Fax: 48 57 47

Czech Republic

OBZOR, výrobní družstvo Zlín
Na Slanici 378
CZ-76413 ZLÍN
Tel: +420 57 7195-111/-153 (Techn. Supp.)
Fax: +420 57 7195-152/-138
ots@obzor.cz

Denmark

THIIM A/S
Transformervej 31
DK-2730 HERLEV
Tel: +45 4485 8000, Fax: 8005
thiim@thiim.com

Finland

Kraus & Naimer Oy
Karitie 7
FIN-01530 VANTAA
Tel: +358 9 825-424-0, Fax: 424-10
myynti@krausnaimer.com

France

Kraus & Naimer s.a.s.
33, rue Bobillot
F-75013 PARIS
Tél: +33 1 58 40 80 80, Fax: 45 80 91 19
ventes@krausnaimer.com

Germany

Kraus & Naimer GmbH
Wikingerstraße 20-28, D-76189 KARLSRUHE
Postfach 10 01 24, D-76231 KARLSRUHE
Tel: +49 721 59 88-0, Fax: 59 28 28
sales.ger@krausnaimer.com

Great Britain

Kraus & Naimer Ltd.
115 London Road
NEWBURY/BERKSHIRE RG14 2AH
Tel: +44 1635 262626, Fax: 37807
sales-uk@krausnaimer.com

Greece

KALAMARAKIS-SAPOUNAS S. A.
Ionias & Neromilou Str., P. O. Box 46566
GR-13671 ACHARNES/ATHENS
Tel: +30 2 10 240-6000-6, Fax: 240-6007
kalamarakis.sapounas@ksa.gr

Hungary

GANZ, Schalter- u. Gerätefabrik
X. Kőbányal út 41/c, Postfach 87
H-1475 BUDAPEST
Tel: +36 1 261-5479, Fax: 4685
ganzkk@ganzkk.hu

Iceland

BRAEDURNIR ORMSSON EHF
Lágmúli 6-9, P. O. Box 8670
REYKJAVIK
Tel: +354 530-28 00, Fax: 28 10
skuli@ormsson.is

India

Liaison Office, **Kraus & Naimer Pte. Ltd.**
10B, 1st Floor, Infinity,
Ashar Commercial Complex, Gladly Alwares Road
Off Pokhran Road no. 2,
THANE (W) 400 610
Tel: +91 22 66716451, Fax: 66716451
india@krausnaimer.com

Republic of Ireland

Kraus & Naimer Ltd.
Bay 145, Shannon Free Zone
SHANNON, Co. Clare
Tel: +353 61 704700, Fax: 471084
sales-ie@krausnaimer.com

Italy

Kraus & Naimer s.r.l.
Via Terracini, 9
I-24047 TREVIGLIO (BG)
Tel: +39 0363-30 11 12, Fax: 30 21 13
sales-ita@krausnaimer.com

Japan

Kraus & Naimer Ltd.
Yoshiwada Building 2F
1-11-6 Hamamatsucho
Minato-Ku, TOKYO 105-0013
Tel: +81 3 3436-6151, Fax: 6325
sales-jpn@krausnaimer.com

Mexico

JC Ingeniería y Control, SA de CV.
Ángel Gaviño 30,
C. Satélite, C. Medicos,
Naucalpan Edo. de Mexico, C.P. 53100
Tel. (+52 55) 55 62 75 77, Fax. 55 62 04 34
ventas@jcingenieraycontrol.com

Middle East - UAE

Branch Office, **Kraus & Naimer Pte. Ltd.**
SAIF Zone, P. O. Box 121607,
Sharjah, UAE
Tel: +971 6 557 8886
Fax: +971 6 557 8088
uae@krausnaimer.com

Netherlands

Kraus & Naimer B.V.
Wegtersweg 38-40, Postbus 199
NL-7556 BR HENGEL0 (Dv.)
Tel: +31 74 291-9441, Fax: 8380
sales.nl@krausnaimer.com

New Zealand

Kraus & Naimer Ltd.
42 Miramar Avenue, WELLINGTON 6022
P. O. Box 15-009, WELLINGTON 6243
Tel: +64 4 380-9888, Fax: 9877
sales-nz@krausnaimer.com

Norway

Kraus & Naimer AS
Hjalmar Brantings vei 8, P. O. Box 21, Økern
N-0508 OSLO
Tel: +47 22 64 44 20, Fax: 65 39 49
ordre.no@krausnaimer.com

Poland

ASTAT sp. z o.o.
ul. Dąbrowskiego 461
PL-60451 POZNAN
Tel: +48 61 848-8871/72, Fax: 8276
info@astat.com.pl

Portugal

ELECTRICOL-DAMAS, FERREIRA & DAMASCENO, LDA.
Apartado 1063, S. Ant. Cavaleiros
P-2670 LOURES
Tel: +351 21 989-8939, Fax: 988-6464
Im.emertex@electricol.pt

Singapore

Kraus & Naimer Pte. Ltd.
Blk 115A, Commonwealth Drive
#03-17/23
SINGAPORE 149 596
Tel: +65 6473-8166, Fax: 8643
sgp@krausnaimer.com

Slovenia

SCHRACK Technik d.o.o.
Pameče 175
SI-2380 Slovenj Gradec
Tel: +386 2 883 92 00, Fax: +386 2 884 34 71
m.abeln@schrack.si

Republic of South Africa

Kraus & Naimer Pty. Ltd.
7 Village Crescent, Linbro Village
Linbro Business Park, SANDTON 2065
P. O. Box 511, KELVIN 2054
Tel: +27 11 608-6060, Fax: 608-2874
salesZAF@krausnaimer.com

Spain

HAZEMEYER HES. S.L.
Pol. Ind. Gaserans
Sector 3, Parcela 7B
17451 SANT FELIU DE BUIXALLEU (GIRONA)
Tel: +34 972 87-4450, Fax: 87-4402
hazemeyer@grupo-hes.net

Sweden

Kraus & Naimer AB
Dr. Widerströms Gata 11, FRUÅNGEN
Box 42097, S-126 14 STOCKHOLM
Tel: +46 8 97 00 80, Fax: 97 87 33
order.se@krausnaimer.com

Switzerland

AWAG Elektrotechnik AG
Sandbühlstraße 2, Postfach
CH-8604 VOLKETSCHWIL
Tel: +41 44 908 19 19, Fax: 19 99
info@awag.ch, www.awag.ch

Turkey

KARDEŞ ELEKTRİK SANAYİ VE TİCARET ANONİM ŞİRKETİ
Beşyol, Eski Londra Asfaltı-6
TR-34295 İSTANBUL-Sefaköy
Tel: +90 212 624-9204, Fax: 592-4810
info@unalkardes.com.tr

USA

Kraus & Naimer Inc.
760 New Brunswick Road
SOMERSET, NJ 08873
Tel: +1 732 560-1240, Fax: 8823
salesusa@krausnaimer.com



Kraus & Naimer

BLUE LINE switchgear



YOUR SALES CONTACT



Kraus & Naimer Produktion GmbH

A-1181 Wien · Schumannngasse 31-39 · PF 0046
Telefon: +43 1 404 06 · Telefax: +43 1 404 06 255
knw@krausnaimer.com · www.krausnaimer.com
124765 d · UID-Nr. ATU 14707101