

Display Elektronik GmbH

DATA SHEET

LCD MODULE

DEM 128064L SBH-PW-N

Product Specification

Ver.: 0

13/Nov./2009

DOCUMENT REVISION HISTORY

Version	DATE	DESCRIPTION	CHANGED BY
0	Nov-13-2009	First Issue	

CONTENTS

1. Functions & Features	2
2. Mechanical Specifications	2
3. Block Diagram	2
4. Dimensional Outline	3
5. LCD Driving Voltage Generator and Bias Reference Circuit	4
6. Pin Description	5
7. Maximum Absolute Limit	6
8. Electrical Characteristics	7
9. Timing Characteristics	8
10. Reset Timing	10
11. Control and Display Command	11
12. Backlight Characteristics	12
13. Electro-Optical Characteristics	12
14. Precaution for using LCD/LCM	13

1. FUNCTIONS & FEATURES

Display Format	: 128x64 Dots, COG
LCD Mode	: STN-BLUE / Negative/ Transmissive Mode
Viewing Direction	: 6 o'clock
Driving Scheme	: 1/65 Duty cycle, 1/9 Bias
Power Supply Voltage (V _{DD})	: 3.3 Volt (typ.)
LCD Driving Voltage (V _{LCD})	: 9.0 Volt (typ. Reference Voltage)
Operation Temperature	: -20°C to +70°C
Storage Temperature	: -30°C to +80°C
Backlight	: LED, Lightguide, White

2. MECHANICAL SPECIFICATIONS

Module Size	: 46.60 x 40.00 x 10.40 mm (without FPC)
Viewing Area	: 37.00 x 28.00 mm
Dot Pitch	: 0.282 x 0.360 mm
Dot Size	: 0.252 x 0.330 mm

3. BLOCK DIAGRAM

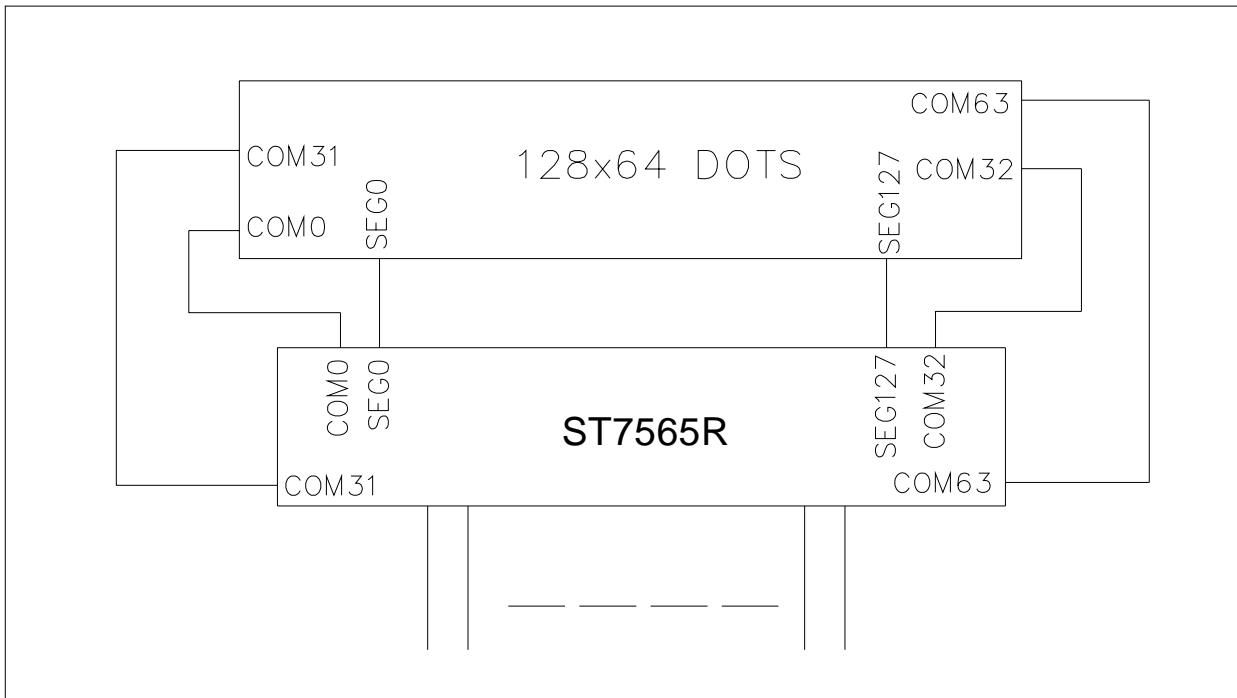

4. DIMENSIONAL OUTLINE

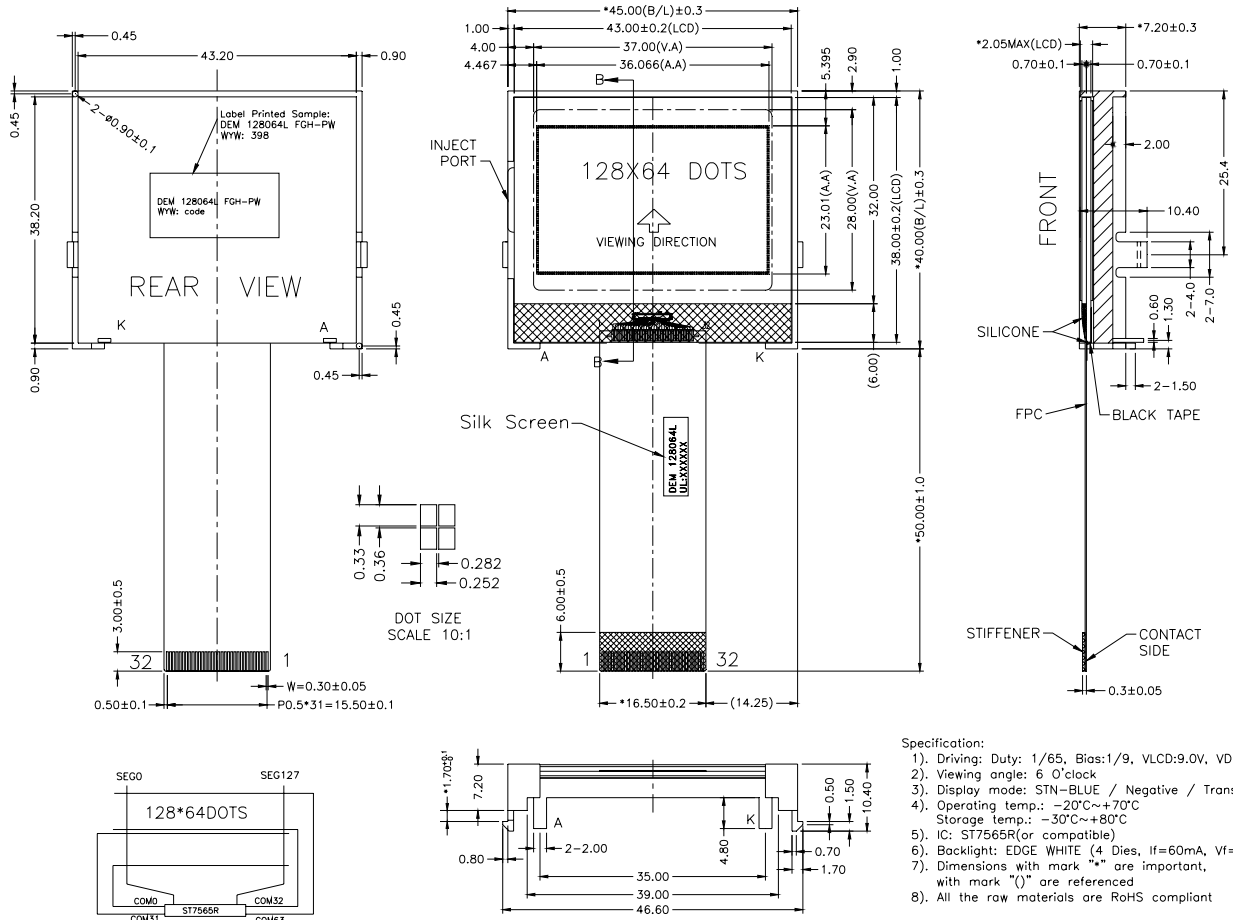

- Specification:
- 1). Driving: Duty: 1/65, Bias: 1/9, VLCD: 9.0V, VDD: 3.3V
 - 2). Viewing angle: 6 O'clock
 - 3). Display mode: STN-BLUE / Negative / Transmissive
 - 4). Operating temp.: -20°C ~ +70°C
Storage temp.: -30°C ~ +80°C
 - 5). IC: ST7565R (or compatible)
 - 6). Backlight: EDGE WHITE (4 Dies, If=60mA, Vf=2.9~3.3V)
 - 7). Dimensions with mark "*" are important, with mark "()" are referenced
 - 8). All the raw materials are RoHS compliant

PIN	1	2	3	4	5	6	7	8	9	10	11	12	13	14	15	16
CONNECTOR	IRS	HPMB	PSB	C86	VR	V0	V1	V2	V3	V4	CAP4+	CAP2-	CAP2+	CAP1+	CAP1-	CAP3+
PIN	17	18	19	20	21	22	23	24	25	26	27	28	29	30	31	32
CONNECTOR	VOUT	VSS	VDD	D7	D6	D5	D4	D3	D2	D1	DO	RD(E)	WR(RW)	AO	/RES	/CS1

5. LCD Driving Voltage Generator and Bias Reference Circuit

When the voltage regulator internal resistor is not used.
(Example where $VDD2=VDD$, with $4\times$ step-up)

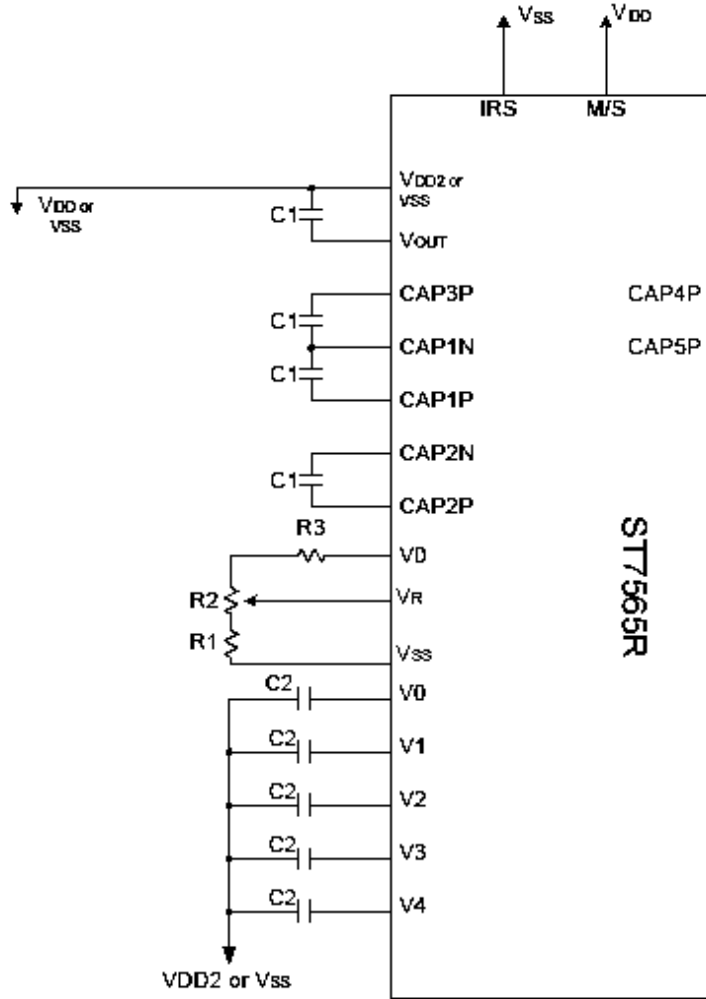

Item	Set value	units
c1	1.0 to 4.7	μF
c2	0.1 to 4.7	μF

C1 and C2 are determined by the size of the LCD being driven

- * 1. Because the VR terminal input impedance is high, use short leads and shielded lines.
- * 2. C1 and C2 are determined by the size of the LCD being driven. Select a value that will stabilize the liquid crystal drive voltage.

Example of the Process by which to Determine the Settings:

- Turn the voltage regulator circuit and voltage follower circuit ON and supply a voltage to VOUT from the outside.
- Determine C2 by displaying an LCD pattern with a heavy load (such as horizontal stripes) and selecting a C2 that stabilizes the liquid crystal drive voltages (V0 to V4). Note that all C2 capacitors must have the same capacitance value.
- Next turn all the power supplies ON and determine C1.

6. PIN DESCRIPTION

PIN	NAME	DESCRIPTION
1	IRS	This terminal selects the resistors for the V0 voltage level adjustment. IRS = "H", Use the internal resistors IRS = "L", Do not use the internal resistors
2	HPMB	This is the power control terminal for the power supply circuit for liquid crystal drive. /HPM = "H": Normal mode /HPM = "L": High power mode (suggested)
3	PSB	This is the parallel data input/4-line SPI data input switch terminal. P/S = "H": Parallel data input. P/S = "L": 4-line SPI data input.
4	C86	This is the MPU interface switch terminal C86 = "H": 6800 Series MPU interface C86 = "L": 8080 Series MPU interface
5	VR	Voltage adjustment pad. Applies voltage between V0 and VSS using a resistive divider.
6~10	V0-V4	LCD driver supplies voltages.
11~17	CAP4+,CAP2-, CAP2+,CAP1+, CAP1-,CAP3+, VOUT	DC/DC voltage converter
18	VSS	Power ground
19	VDD	Power supply for logic(+3.3V)
20~27	D7~D0	Data bus lines
28	RD(E)	Enable signal

29	WR(RW)	Write signal
30	A0	This is connected to the least significant bit of the normal MPU address bus, and it determines whether the data bits are data or a command
31	/RES	The RESET signal
32	/CS1	This is the chip select signal

7. MAXIMUM ABSOLUTE LIMIT

Maximum Ratings (Voltage Reference to VSS) (for IC)

Unless otherwise noted, $V_{SS} = 0V$

Table 17

Parameter	Symbol	Conditions	Unit	
Power Supply Voltage	VDD	-0.3 ~ 3.6	V	
Power supply voltage (VDD standard)	VDD2	-0.3 ~ 3.6	V	
Power supply voltage (VDD standard)	V0, VOUT	-0.3 ~ 13.5	V	
Power supply voltage (VDD standard)	V1, V2, V3, V4	-0.3 to V0	V	
Operating temperature	TOPR	-30 to +85	°C	
Storage temperature	Bare chip	TSTR	-65 to +150	°C

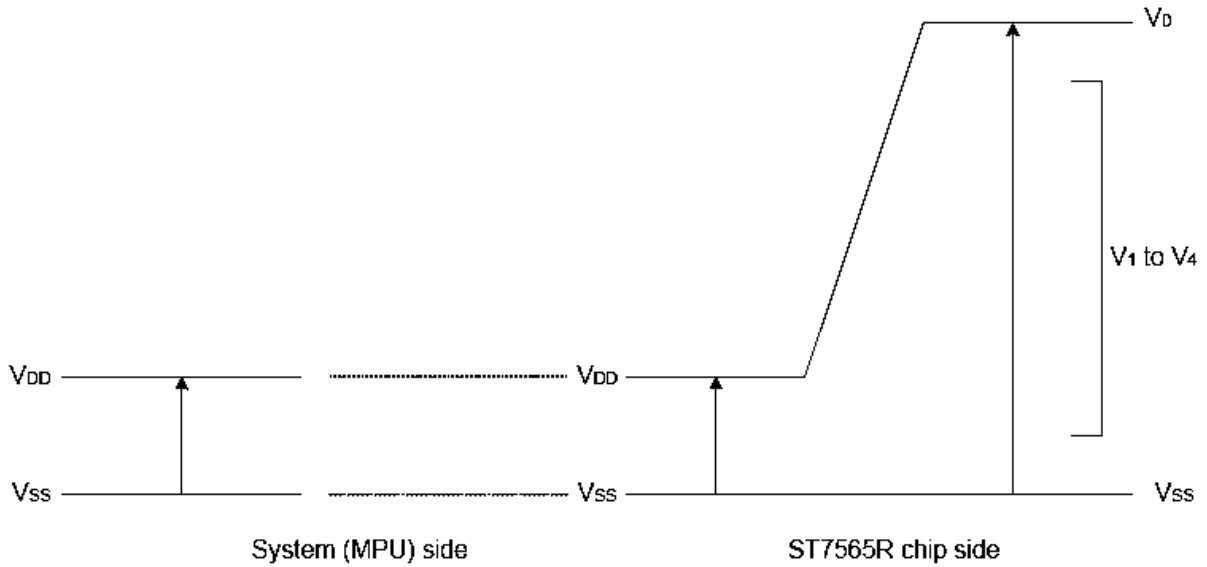

Figure 30

Notes and Cautions

1. The V_{DD2} , V_0 to V_4 and V_{OUT} are relative to the $V_{SS} = 0V$ reference.
2. Insure that the voltage levels of V_1 , V_2 , V_3 , and V_4 are always such that $V_{OUT} \geq V_0 \geq V_1 \geq V_2 \geq V_3 \geq V_4$.
3. Permanent damage to the LSI may result if the LSI is used outside of the absolute maximum ratings. Moreover, it is recommended that in normal operation the chip be used at the electrical characteristic conditions, and use of the LSI outside of these conditions may not only result in malfunctions of the LSI, but may have a negative impact on the LSI reliability as well.

8. ELECTRICAL CHARACTERISTICS

Item	Symbol	Condition	Rating			Units	Applicable Pin		
			Min.	Typ.	Max.				
Operating Voltage (1)	V _{DD}		1.8	—	3.3	V	V _{SS} *1		
Operating Voltage (2)	V _{DD2}	(Relative to V _{SS})	2.4	—	3.3	V	V _{SS}		
High-level Input Voltage	V _{IHC}		0.8 x V _{DD}	—	V _{DD}	V	*3		
Low-level Input Voltage	V _{ILC}		V _{SS}	—	0.2 x V _{DD}	V	*3		
High-level Output Voltage	V _{OHC}	I _{OH} = -0.5 mA	0.8 x V _{DD}	—	V _{DD}	V	*4		
Low-level Output Voltage	V _{OLC}	I _{OL} = 0.5 mA	V _{SS}	—	0.2 x V _{DD}	V	*4		
Input leakage current	I _{LI}	V _{IN} = V _{DD} or V _{SS}	-1.0	—	1.0	μA	*5		
Output leakage current	I _{LO}	V _{IN} = V _{DD} or V _{SS}	-3.0	—	3.0	μA	*6		
Liquid Crystal Driver ON Resistance	R _{ON}	T _a = 25°C V _O = 13.0 V (Relative To V _{DD}) V _O = 8.0 V	—	2.0	3.5	KΩ	SE _{Gn} CO _{Mn} *7		
Static Consumption Current	I _{SSQ}	V _O = 13.0 V (Relative To V _{DD})	—	0.01	2			μA	V _{DD} , V _{DD2}
Output Leakage Current	I _{SO}		—	0.01	10	μA	V _O		
Input Terminal Capacitance	C _{IN}	T _a = 25°C, f = 1 MHz	—	5.0	8.0	pF			
Oscillator Frequency	Internal Oscillator	f _{OSC}	1/65 duty 1/33 duty	T _a = 25°C	17	20	24	kHz	*8
	External Input	f _{OL}							
	Internal Oscillator	f _{OSC}	1/49 duty 1/53 duty 1/55 duty	T _a = 25°C	25	30	35	kHz	*8
	External Input	f _{OL}							

Item	Symbol	Condition	Rating			Units	Applicable Pin	
			Min.	Typ.	Max.			
Internal Power	Input voltage	V _{DD2}	(Relative To V _{SS})	2.4	—	3.3	V	V _{SS}
	Supply Step-up output voltage Circuit	V _{OUT}	(Relative To V _{SS})	—	—	13.5	V	V _{OUT}
	Voltage regulator Circuit Operating Voltage	V _{OUT}	(Relative To V _{SS})	6.0	—	13.5	V	V _{OUT}
	Voltage Follower Circuit Operating Voltage	V _O	(Relative To V _{SS})	4.0	—	13.5	V	V _O *9
	Base Voltage	V _{RS}	T _a = 25°C, (Relative To V _{SS}) -0.05%/°C	2.07	2.10	2.13	V	*10

9. TIMING CHARACTERISTICS

System Bus Read/Write Characteristics 1 (For the 8080 Series MPU)

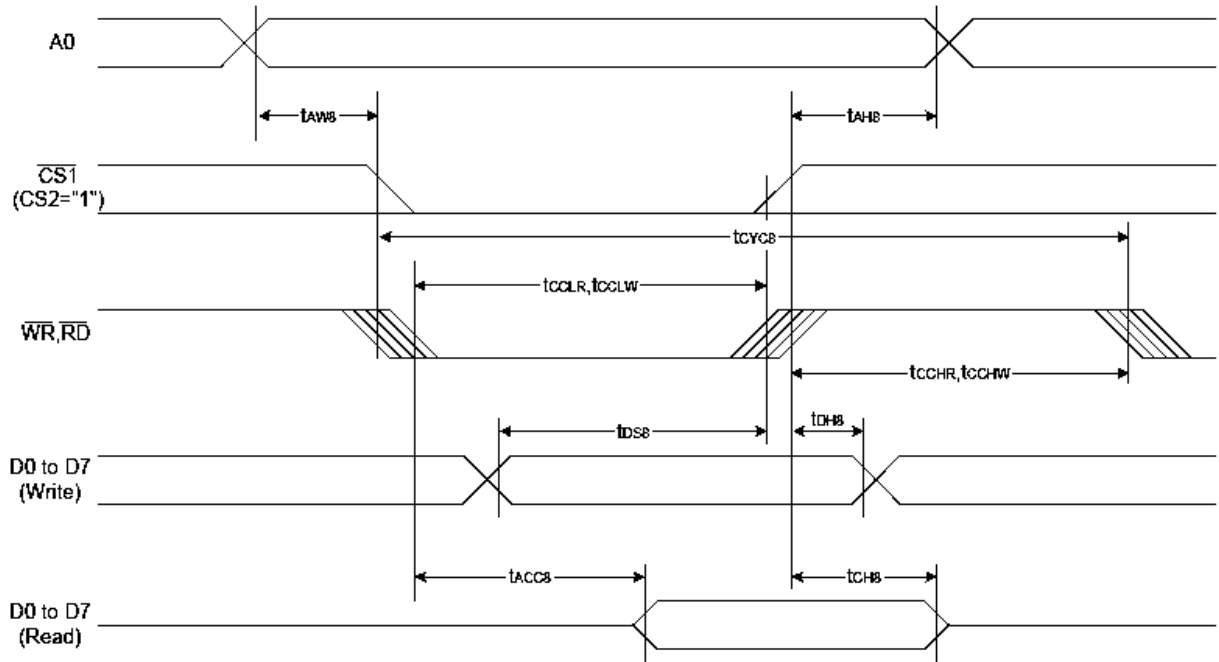

(VDD = 3.3V, Ta = -30 to 85°C)

Item	Signal	Symbol	Condition	Rating		Units
				Min.	Max.	
Address hold time	A0	tAHS		0	—	Ns
Address setup time		tAWs		0	—	
System cycle time		tCYcS		240	—	
Enable L pulse width (WRITE)	WR	tCCLW		80	—	
Enable H pulse width (WRITE)		tCCHW		80	—	
Enable L pulse width (READ)	RD	tCCLR		140	—	
Enable H pulse width (READ)		tCCHR		80	—	
WRITE Data setup time	D0 to D7	tDSB		40	—	
WRITE Address hold time		tDHS		0	—	
READ access time		tACCs	CL = 100 pF	—	70	
READ Output disable time		tOHS	CL = 100 pF	5	50	

System Bus Read/Write Characteristics 2 (For the 6800 Series MPU)

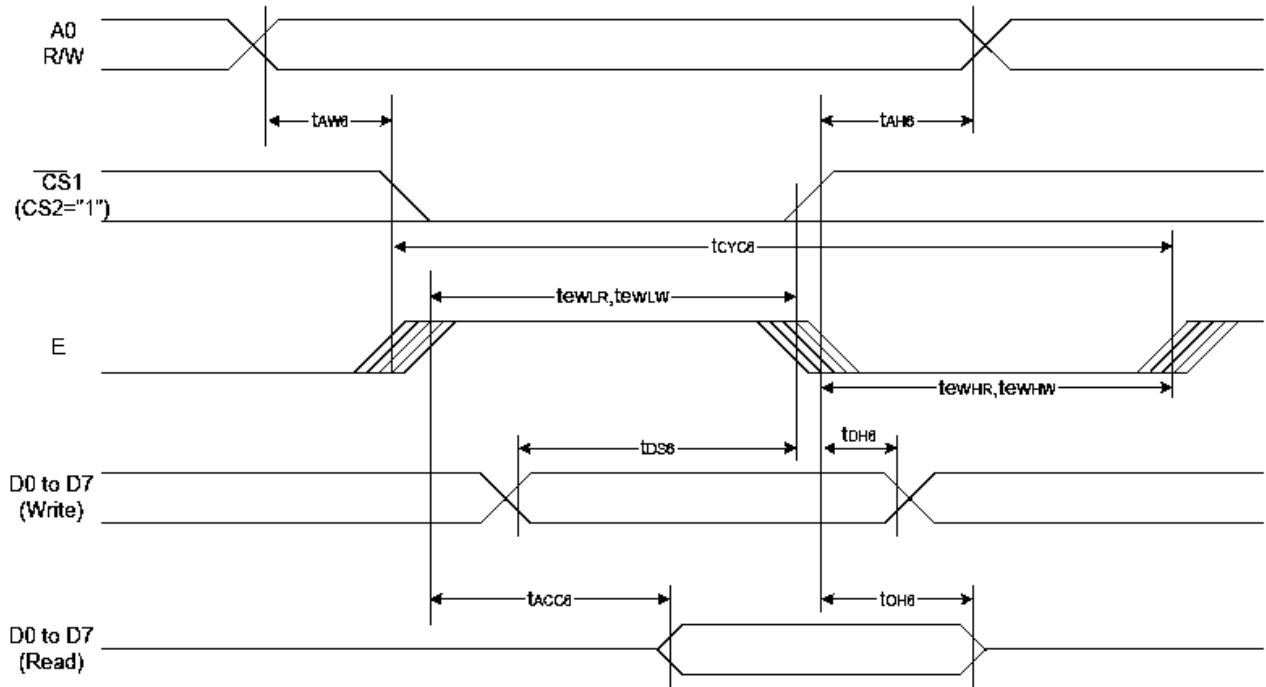

(VDD = 3.3V, Ta = -30 to 85°C)

Item	Signal	Symbol	Condition	Rating		Units
				Min.	Max.	
Address hold time	A0	tAH6		0	—	ns
Address setup time		tAW6		0	—	
System cycle time		tCYC6		240	—	
Enable L pulse width (WRITE)	WR	tEWLW		80	—	
Enable H pulse width (WRITE)		tEWHW		80	—	
Enable L pulse width (READ)	RD	tEWLR		80	—	
Enable H pulse width (READ)		tEWHR		140	—	
WRITE Data setup time	D0 to D7	tDS6		40	—	
WRITE Address hold time		tDH6		0	—	
READ access time		tACC6	CL = 100 pF	—	70	
READ Output disable time		tOH6	CL = 100 pF	5	50	

The 4-line SPI interface

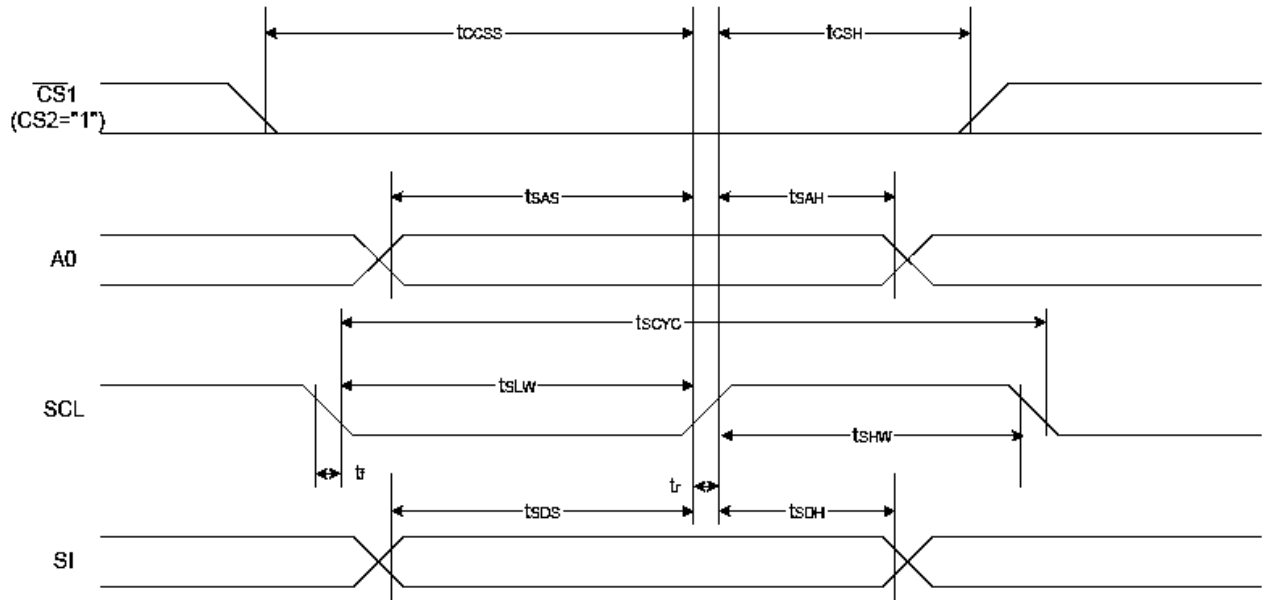

(VDD = 3.3V, Ta = -30 to 85 °C)

Item	Signal	Symbol	Condition	Rating		Units
				Min.	Max.	
4-line SPI Clock Period	SCL	T_{scyc}		50	—	ns
SCL "H" pulse width		T_{shw}		25	—	
SCL "L" pulse width		T_{slw}		25	—	
Address setup time	A0	T_{sas}		20	—	
Address hold time		T_{sah}		10	—	
Data setup time	SI	T_{sds}		20	—	
Data hold time		T_{sdh}		10	—	
CS-SCL time	CS	T_{css}		20	—	
CS-SCL time		T_{csh}		40	—	

10. Reset Timing

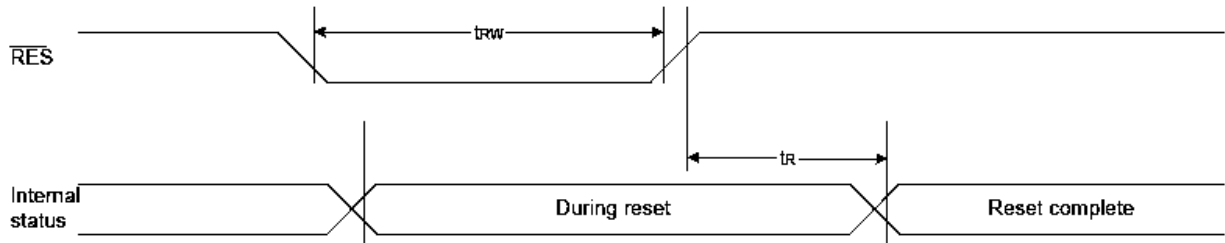

(VDD = 3.3V, Ta = -30 to 85 °C)

Item	Signal	Symbol	Condition	Rating			Units
				Min.	Typ.	Max.	
Reset time		t_r		—	—	1.0	us
Reset "L" pulse width	\overline{RES}	t_{RW}		1.0	—	—	us

11. CONTROL AND DISPLAY INSTRUCTION

Command	Command Code									Function				
	A0	/RD	/WR	D7	D6	D5	D4	D3	D2		D1	D0		
(1) Display ON/OFF	0	1	0	1	0	1	0	1	1	1	0	1	LCD display ON/OFF 0: OFF, 1: ON	
(2) Display start line set	0	1	0	0	1	Display start address					0	1	Sets the display RAM display start line address	
(3) Page address set	0	1	0	1	0	1	Page address				0	1	Sets the display RAM page address	
(4) Column address set upper bit	0	1	0	0	0	0	1	Most significant column address				0	1	Sets the most significant 4 bits of the display RAM column address.
Column address set lower bit				0	0	0	0	Least significant column address				0	1	Sets the least significant 4 bits of the display RAM column address.
(5) Status read	0	0	1	Status				0	0	0	0	0	Reads the status data	
(6) Display data write	1	1	0	Write data							0	1	Writes to the display RAM	
(7) Display data read	1	0	1	Read data							0	1	Reads from the display RAM	
(8) ADC select	0	1	0	1	0	1	0	0	0	0	0	0	1	Sets the display RAM address SEG output correspondence 0: normal, 1: reverse
(9) Display normal/reverse	0	1	0	1	0	1	0	0	1	1	0	0	1	Sets the LCD display normal/ reverse 0: normal, 1: reverse
(10) Display all points ON/OFF	0	1	0	1	0	1	0	0	1	0	0	0	1	Display all points 0: normal display 1: all points ON
(11) LCD bias set	0	1	0	1	0	1	0	0	0	1	0	0	1	Sets the LCD drive voltage bias ratio 0: 1/9 bias, 1: 1/7 bias (ST7565R)
(12) Read/modify/write	0	1	0	1	1	1	0	0	0	0	0	0	0	Column address increment At write: +1 At read: 0
(13) End	0	1	0	1	1	1	0	1	1	1	0	0	0	Clear read/modify/write
(14) Reset	0	1	0	1	1	1	0	0	0	1	0	0	0	Internal reset
(15) Common output mode select	0	1	0	1	1	0	0	0	*	*	*	1	*	Select COM output scan direction 0: normal direction 1: reverse direction
(16) Power control set	0	1	0	0	0	1	0	1	Operating mode			0	1	Select internal power supply operating mode
(17) V ₀ voltage regulator internal resistor ratio set	0	1	0	0	0	1	0	0	Resistor ratio			0	1	Select internal resistor ratio(R _b /R _a) mode
(18) Electronic volume mode set	0	1	0	1	0	0	0	0	0	0	0	0	1	Set the V ₀ output voltage electronic volume register
Electronic volume register set				0	0	Electronic volume value					0	1		
(19) Static indicator ON/OFF	0	1	0	1	0	1	0	1	1	0	0	0	0	0: OFF, 1: ON Set the flashing mode
Static indicator register set				0	0	0	0	0	0	0	0	0	Mode	
(20) Booster ratio set	0	1	0	1	1	1	1	1	0	0	0	0	0	select booster ratio 00: 2x,3x,4x 01: 5x 11: 6x
(21) Power save	0	1	0								0	1	Display OFF and display all points ON compound command	
(22) NOP	0	1	0	1	1	1	0	0	0	1	1	0	0	Command for non-operation
(23) Test	0	1	0	1	1	1	1	*	*	*	*	*	*	Command for IC test. Do not use this command

12. BACK LIGHT CHARACTERISTICS

LCD Module with Side LED Backlight
ELECTRICAL RATINGS

Ta = 25°C

Item	Symbol	Condition	Min	Typ	Max	Unit
Forward Voltage	VF	IF=60mA	2.9	3.1	3.3	V
Reverse Current	IR	VR=0.8V	---	15	---	mA
Luminance(without LCD)	Lv	IF=60mA	420	500	---	cd/m ²
Wave length(without LCD)	λp	IF=60mA	X=0.26 Y=0.27	---	X=0.30 Y=0.31	
Color			White			

Note:

when the temperature exceed 25°C, the approved current decrease rate for Backlight change as the temperature increase is: -0.36m*4mA/°C(below 25°C, the current refer to constant, which would not change with temperature).

13. ELECTRO-OPTICAL CHARACTERISTICS

(VDD=3.3V,Ta = 25°C)

Item	Symbol	Condition	Min	Typ	Max	Unit
Operating Voltage for LCD	Vop	Ta =-20°C	9.3	9.6	9.9	V
		Ta = 25°C	8.8	9.1	9.4	
		Ta = 70°C	8.3	8.6	8.9	
Response time	Tr	Ta = 25°C	---	200	400	ms
	Tf		---	250	500	ms
Contrast	Cr	Ta = 25°C	---	4.0	---	---
Viewing angle range	θ	Cr ≥ 2	-40	---	+40	deg
	Φ		-40	---	+40	deg

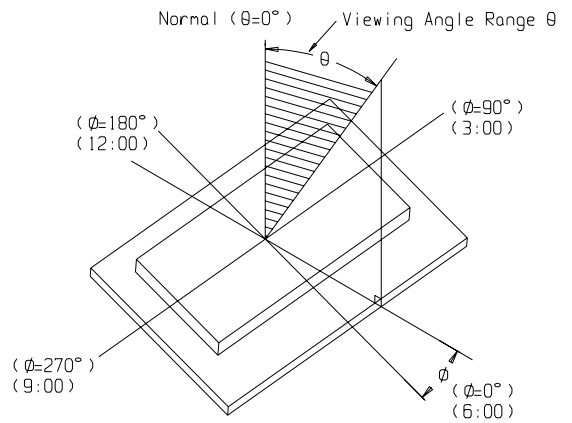
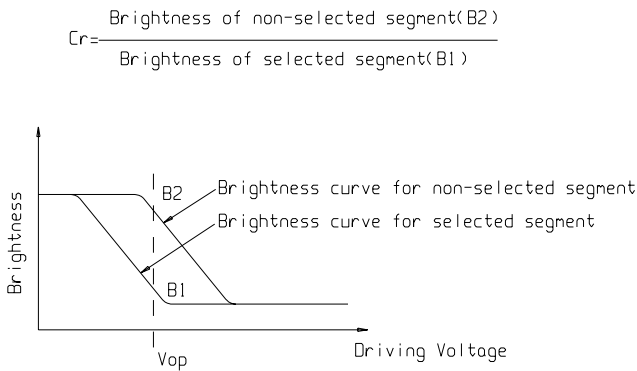

14. PRECAUTION FOR USING LCD/LCM

After reliability test, recovery time should be 24 hours minimum. Moreover, functions, performance and appearance shall be free from remarkable deterioration within 50,000 hours (average) under ordinary operating and storage conditions room temperature (20±8°C), normal humidity (below 65% RH), and in the area not exposed to direct sun light. Using LCM beyond these conditions will shorten the life time.

Precaution for using LCD/LCM

LCD/LCM is assembled and adjusted with a high degree of precision. Do not attempt to make any alteration or modification. The followings should be noted.

General Precautions:

1. LCD panel is made of glass. Avoid excessive mechanical shock or applying strong pressure onto the surface of display area.
2. The polarizer used on the display surface is easily scratched and damaged. Extreme care should be taken when handling. To clean dust or dirt off the display surface, wipe gently with cotton, or other soft material soaked with isopropyl alcohol, ethyl alcohol or trichlorotrifluoroethane, do not use water, ketone or aromatics and never scrub hard.
3. Do not tamper in any way with the tabs on the metal frame.
4. Do not make any modification on the PCB without consulting DISPLAY.
5. When mounting a LCM, make sure that the PCB is not under any stress such as bending or twisting. Elastomer contacts are very delicate and missing pixels could result from slight dislocation of any of the elements.
6. Avoid pressing on the metal bezel, otherwise the elastomer connector could be deformed and lose contact, resulting in missing pixels and also cause rainbow on the display.
7. Be careful not to touch or swallow liquid crystal that might leak from a damaged cell. Any liquid crystal adheres to skin or clothes, wash it off immediately with soap and water.

Static Electricity Precautions:

1. CMOS-LSI is used for the module circuit; therefore operators should be grounded whenever he/she comes into contact with the module.
2. Do not touch any of the conductive parts such as the LSI pads; the copper leads on the PCB and the interface terminals with any parts of the human body.
3. Do not touch the connection terminals of the display with bare hand; it will cause disconnection or defective insulation of terminals.
4. The modules should be kept in anti-static bags or other containers resistant to static for storage.
5. Only properly grounded soldering irons should be used.
6. If an electric screwdriver is used, it should be grounded and shielded to prevent sparks.
7. The normal static prevention measures should be observed for work clothes and working benches.
8. Since dry air is inductive to static, a relative humidity of 50-60% is recommended.

Soldering Precautions:

1. Soldering should be performed only on the I/O terminals.
2. Use soldering irons with proper grounding and no leakage.
3. Soldering temperature: $350^{\circ}\text{C} \pm 10^{\circ}\text{C}$
4. Soldering time: 3 to 4 second.
5. Use eutectic solder with resin flux filling.
6. If flux is used, the LCD surface should be protected to avoid spattering flux.
7. Flux residue should be removed.

Operation Precautions:

1. The viewing angle can be adjusted by varying the LCD driving voltage V_o .
2. Since applied DC voltage causes electro-chemical reactions, which deteriorate the display, the applied pulse waveform should be a symmetric waveform such that no DC component remains. Be sure to use the specified operating voltage.
3. Driving voltage should be kept within specified range; excess voltage will shorten display life.
4. Response time increases with decrease in temperature.
5. Display color may be affected at temperatures above its operational range.
6. Keep the temperature within the specified range usage and storage. Excessive temperature and humidity could cause polarization degradation, polarizer peel-off or generate bubbles.
7. For long-term storage over 40°C is required, the relative humidity should be kept below 60%, and avoid direct sunlight.

Limited Warranty

DISPLAY LCDs and modules are not consumer products, but may be incorporated by DISPLAY's customers into consumer products or components thereof, DISPLAY does not warrant that its LCDs and components are fit for any such particular purpose.

1. The liability of DISPLAY is limited to repair or replacement on the terms set forth below. DISPLAY will not be responsible for any subsequent or consequential events or injury or damage to any personnel or user including third party personnel and/or user. Unless otherwise agreed in writing between DISPLAY and the customer, DISPLAY will only replace or repair any of its LCD which is found defective electrically or visually when inspected in accordance with DISPLAY general LCD inspection standard . (Copies available on request)
2. No warranty can be granted if any of the precautions state in handling liquid crystal display above has been disregarded. Broken glass, scratches on polarizer mechanical damages as well as defects that are caused accelerated environment tests are excluded from warranty.
3. In returning the LCD/LCM, they must be properly packaged; there should be detailed description of the failures or defect.