

## M12 female 90° shielded with cable

PUR 4x0.34 shielded bk UL/CSA+drag chain 35m

M12

Female 90°

4-pole, shielded

Plastic housings with good resistance against chemicals and oils. The resistance to aggressive media should be individually tested for your application. Further details on request. Further cable lengths on request.

### [Link to Product](#)

#### Illustration

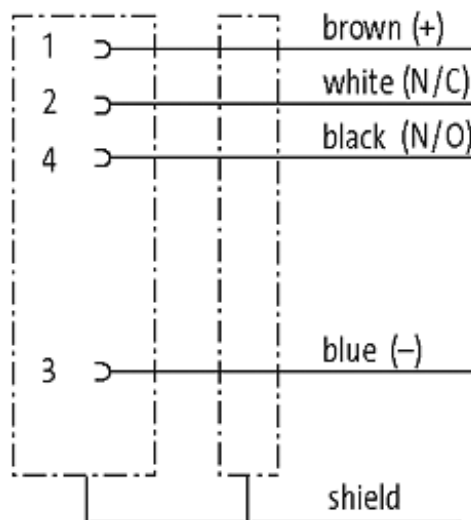

# Female

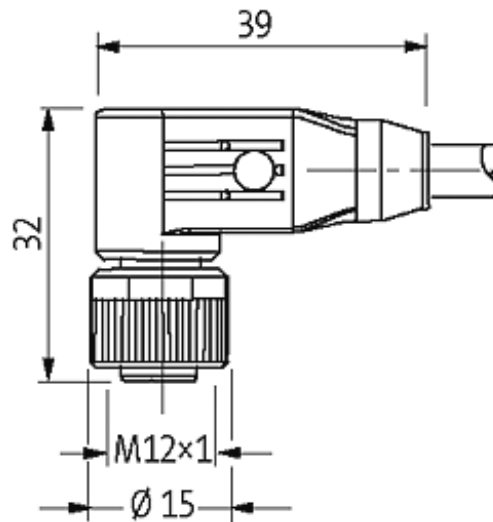

Product may differ from Image