

M12 male 90° / M12 female 90° DeviceNet

PUR AWG24+AWG22 shielded vt UL/CSA+drag ch. 0,8m

DeviceNet, CANopen
 Male 90° to female 90°
 M12 - M12
 5-pole, shielded

Plastic housings with good resistance against chemicals and oils. The resistance to aggressive media should be individually tested for your application. Further details on request. Further cable lengths on request.

[Link to Product](#)

Illustration

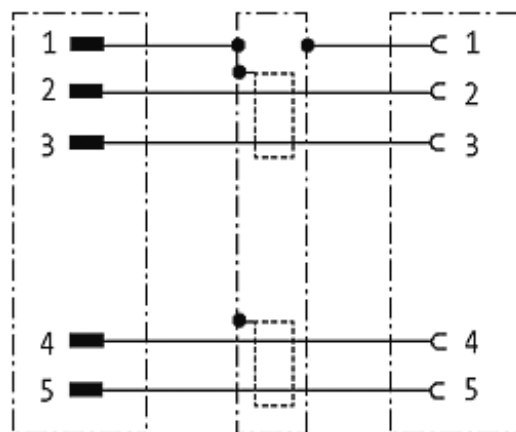

Male

Female

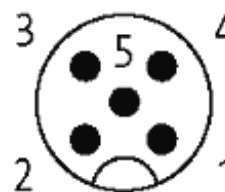
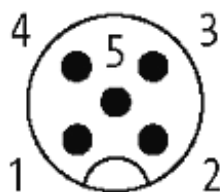

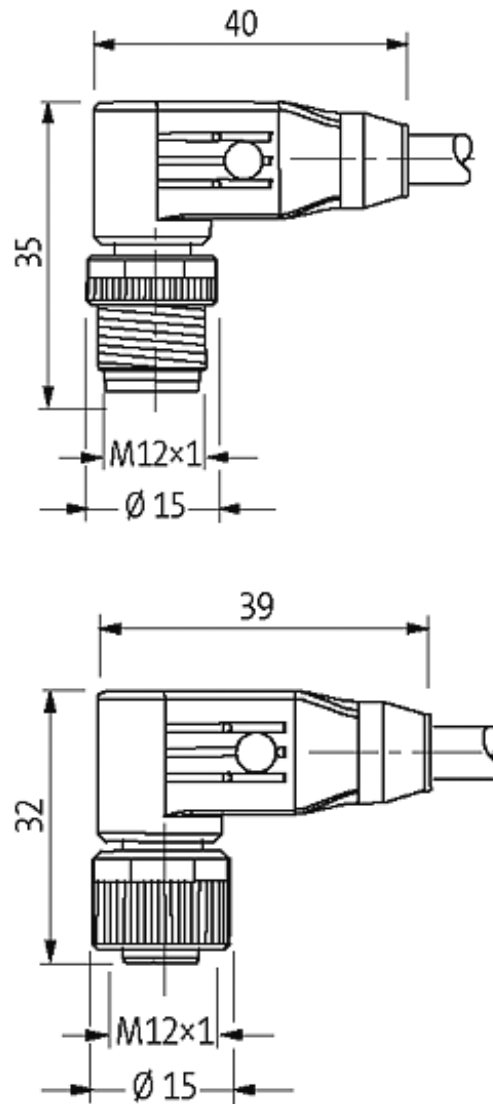

Product may differ from Image

Approvals



More Info



Form

40551

Technical Data

Operating voltage	max. 60 V AC/DC
Operating current per contact	max. 4 A

The information in this brochure has been compiled with the utmost care.

Liability for the correctness completeness and topicality of the information is restricted to gross negligence. Version: 05/15

Murrelektronik GmbH | Falkenstraße 3, 71570 Oppenweiler | Fon +49 (71 91) 47-0, Fax +49 (71 91) 47-491000 | shop@murrelektronik.de | shop.murrelektronik.de

Locking of ports	Screw thread M12 × 1 mm (recommended torque 0.6 Nm) self-securing
Protection	IP67 inserted and tightened (EN 60529)

Cables

Cable number	803
No./diameter of wires	2×0.25 + 2×0.34 mm ²
Wire isolation	PE (rd, bk), (bl, wh)
C-track properties	5 Mio.
Jacket Color	violet
Shore hardness outer jacket	90 ± 5A
Material (jacket)	PUR (UL/CSA)
Outer diameter	approx. 6.9 mm
Bend radius (fixed)	8 × outer Ø
Bend radius (moving)	12 × outer Ø
Temperature range (fixed)	-40...+80 °C
Temperature range (mobile)	-20...+60 °C
Shielded	yes

Commercial data

country of origin	DE
customs tariff number	85444290
minimum order quantity	1