



Figure similar

ACCES.F.FUSE SWI. DISCONNECTOR FOR NH2
 FUSE CARRIER WITH FUSE MONITORING
 ELECTRONIC, EFM 10

Model	
product brand name	SENTRON
Design of the product	for 3NP1 fuse switch disconnectors, fuse carrier with EFM10 electronic fuse monitoring, for size NH2

Accessories	
accessories	cover

General Product Approval	Declaration of Conformity	Test Certificates
--------------------------	---------------------------	-------------------



[Type Test Certificates/Test Report](#)

Further information

Information- and Downloadcenter (Catalogs, Brochures,...)

<http://www.siemens.com/lowvoltage/catalogs>

Industry Mall (Online ordering system)

<https://eb.automation.siemens.com/mall/en/WW/Catalog/Product/3NP19531GB20>

Service&Support (Manuals, Certificates, Characteristics, FAQs,...)

<http://support.automation.siemens.com/WW/view/en/3NP19531GB20/all>

Image database (product images, 2D dimension drawings, 3D models, device circuit diagrams, ...)

http://www.automation.siemens.com/bilddb/cax_en.aspx?mfb=3NP19531GB20

CAX-Online-Generator

<http://www.siemens.com/cax>

Tender specifications

<http://ausschreibungstexte.siemens.com/tiplv>

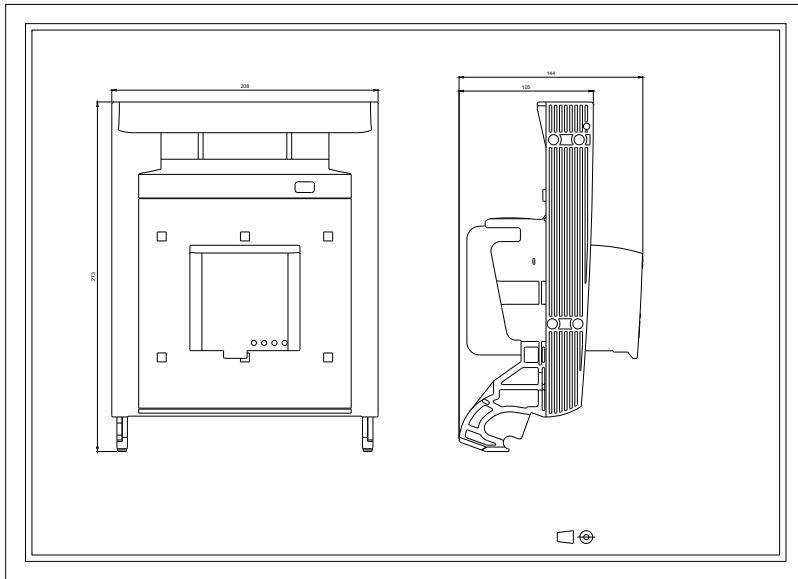

last modified:

11.03.2015