



SIRIUS POSITION SWITCH; PLASTIC HOUSING ACC. TO EN50047, 50MM DEVICE CONNECTION 2X(M20X1.5); 1NO/1NC SNAP-ACTION CONTACTS ROLLER PLUNGER W. PLASTIC ROLLER 10MM

Product designation		standard position switch
Manufacturer article number		
<ul style="list-style-type: none"> • of the supplied basic switch • of the supplied actuator head for position switches 		3SE5242-0HC05 3SE5000-0AD03

General technical data:		
Product function		
<ul style="list-style-type: none"> • positive opening 		Yes
Insulation voltage		
<ul style="list-style-type: none"> • Rated value 	V	400
Degree of pollution		class 3
Shock resistance		30g / 11 ms
Vibration resistance		0.35 mm / 5g
Surge voltage resistance Rated value	kV	6
Mechanical service life (switching cycles)		
<ul style="list-style-type: none"> • typical 		15 000 000
Electrical endurance (switching cycles)		
<ul style="list-style-type: none"> • at AC-15 at 230 V typical 		100 000
Electrical endurance (switching cycles) with contactor 3RH11, 3RT1016, 3RT1017, 3RT1024, 3RT1025, 3RT1026 typical		10 000 000
Electrical operating cycles in one hour with contactor 3RH11, 3RT1016, 3RT1017, 3RT1024, 3RT1025, 3RT1026		6 000
Thermal current	A	6
Material of the enclosure of the switch head		plastic

Protection class IP		IP66/IP67
Equipment marking		
<ul style="list-style-type: none"> • acc. to DIN EN 61346-2 • acc. to DIN EN 81346-2 		B B
Active principle		mechanical
Repeat accuracy	mm	0.05
Explosion protection category for dust		none
Explosion protection category for gas		none
Minimum actuating force in activation direction	N	20
Operating current at AC-15		
<ul style="list-style-type: none"> • at 230 V Rated value • at 400 V Rated value 	A A	6 4
Operating current		
<ul style="list-style-type: none"> • at DC-13 at 125 V Rated value • at DC-13 at 400 V Rated value 	A A	0.55 0.1
Operating current		
<ul style="list-style-type: none"> • at DC-13 <ul style="list-style-type: none"> — at 24 V Rated value 	A	3

Enclosure:

Design of the housing		block, wide
Material of the enclosure		plastic
Coating of the enclosure		Other types
Design of the housing acc. to standard		No

Drive Head:

Design of the operating mechanism		plastic roller
Standard-compliant actuator head		EN 50047, design C
Shape of the switch head		roller
Design of the switching function		positive opening, integrated

Connections/ Terminals:

Type of electrical connection		screw-type terminals
Type of connectable conductor cross-section		
<ul style="list-style-type: none"> • solid 		1x (0.5 ... 1.5 mm ²), 2x (0.5 ... 0.75 mm ²)
<ul style="list-style-type: none"> • finely stranded with core end processing 		1x (0.5 ... 1.5 mm ²), 2x (0.5 ... 0.75 mm ²)
<ul style="list-style-type: none"> • finely stranded without core end processing 		1x (0.5 ... 1.5 mm ²), 2x (0.5 ... 0.75 mm ²)
<ul style="list-style-type: none"> • for AWG conductors <ul style="list-style-type: none"> — solid — stranded 		1x (20 ... 16), 2x (20 ... 18) 1x (20 ... 16), 2x (20 ... 18)

Mechanical data:

Cable entry type		2 x (M20 x 1.5)
-------------------------	--	-----------------

Communication/ Protocol:

Design of the interface		without
-------------------------	--	---------





Ambient conditions:

Ambient temperature		
• during operation	°C	-25 ... +85
• during storage	°C	-40 ... +90

Installation/ mounting/ dimensions:

mounting position		any
Mounting type		screw fixing

Certificates/ approvals:

General Product Approval	Declaration of Conformity	Test Certificates	other
 CSA	 UL		 EG-Konf.
		Special Test Certificate	Confirmation

Further information

Information- and Downloadcenter (Catalogs, Brochures,...)

<http://www.siemens.com/industrial-controls/catalogs>

Industry Mall (Online ordering system)

<http://www.siemens.com/industrymall>

Cax online generator

<http://support.automation.siemens.com/WW/CAXorder/default.aspx?lang=en&mlfb=3SE52420HD03>

Service&Support (Manuals, Certificates, Characteristics, FAQs,...)

<http://support.automation.siemens.com/WW/view/en/3SE52420HD03/all>

Image database (product images, 2D dimension drawings, 3D models, device circuit diagrams, EPLAN macros, ...)

http://www.automation.siemens.com/bilddb/cax_de.aspx?mlfb=3SE52420HD03&lang=en

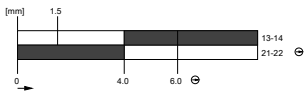
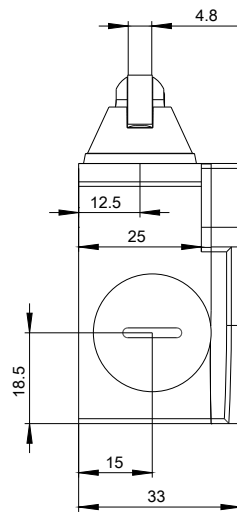
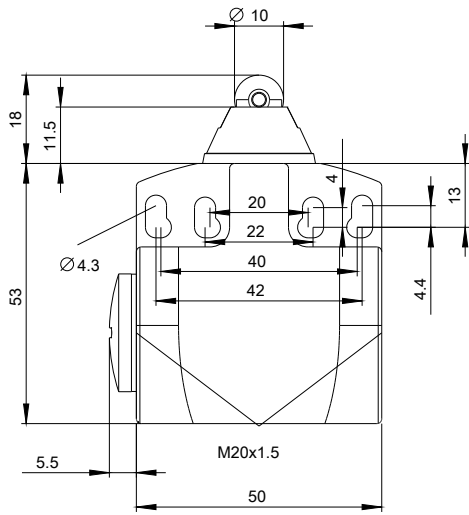

last modified:

09.03.2015