

MAX77857 Evaluation Kit

Evaluates: MAX77857 (WLP)

General Description

The MAX77857 evaluation kit (EV kit) is a fully assembled and tested printed circuit board (PCB) that demonstrates the MAX77857, a high-efficiency, high-performance buck-boost regulator with a switching current of 7A. The IC is capable of 2.5V to 16V input and dynamically adjustable output between 4.5V to 15V when using internal feedback resistors, or between 3V to 15V when using external feedback resistors. The EV kit is factory-configured as internal feedback with default startup output voltage at 5V. Other startup voltages can be achieved with external feedback resistors. The output voltage can be adjusted dynamically through the I²C serial interface.

I/O pins are available to support the I²C serial interface, Enable function, and interrupt/Power-OK indicator. The I²C slave address, switching current limit, and feedback configuration can be adjusted by changing the R_{SEL} resistor value (R9). MAXUSB_INTERFACE# allows the use of Windows®-based software with a friendly graphical user interface (GUI) as well as a detailed register-based interface to exercise all features of the IC. The EV kit is compatible with any version of the MAX77857 WLP IC (MAX77857BEWB+T is the default installed on the EV kit).

Features

- Proven PCB Reference Design and Layout Benefit
- Fully Assembled and Tested
- Sense Points for High-Accuracy Measurements
- Accessible Test Point Pins for EN, POKB/INTB, V_{IO}, and I²C Serial Interface SCL, SDA
- MAXUSB_INTERFACE# Allows Easy Communication with a Windows PC
- GUI Software that Drives I²C Serial Interface for Optional Software Control
- Startup Output Voltage Adjustable Through External Feedback Resistors
- Output Voltage Dynamically Adjustable Through I²C Serial Interface
- I²C Slave Address, Switching Current Limit, and Feedback Configuration Adjustable Using R_{SEL} (R9)

Ordering Information appears at end of data sheet.

Check List

- MAX77857 IC Evaluation Board
- MAXUSB_INTERFACE# (USB to I²C Serial Interface)
- USB Type-A to Micro-USB Cable
- Windows-based Graphical User Interface (GUI) Software
 - Can be downloaded from Maxim's website at <https://www.maximintegrated.com/products/MAX77857WEVKIT> (under the *Design Resources* tab). Windows 7 or newer is required to use the EV kit GUI software.

EV Kit Specifications

SPECIFICATION	TEST CONDITION	MIN	TYP	MAX	UNIT
Input voltage		2.5		16	V
Output voltage	Internal feedback	4.5		15	V
	External feedback	3		15	
Default output voltage	Internal feedback		5		V
Switching current limit			7		A
Peak efficiency	V _{IN} = 4V, V _{OUT} = 5V, 700mA load		97.0		%

Windows is a registered trademark and registered service mark of Microsoft Corporation.

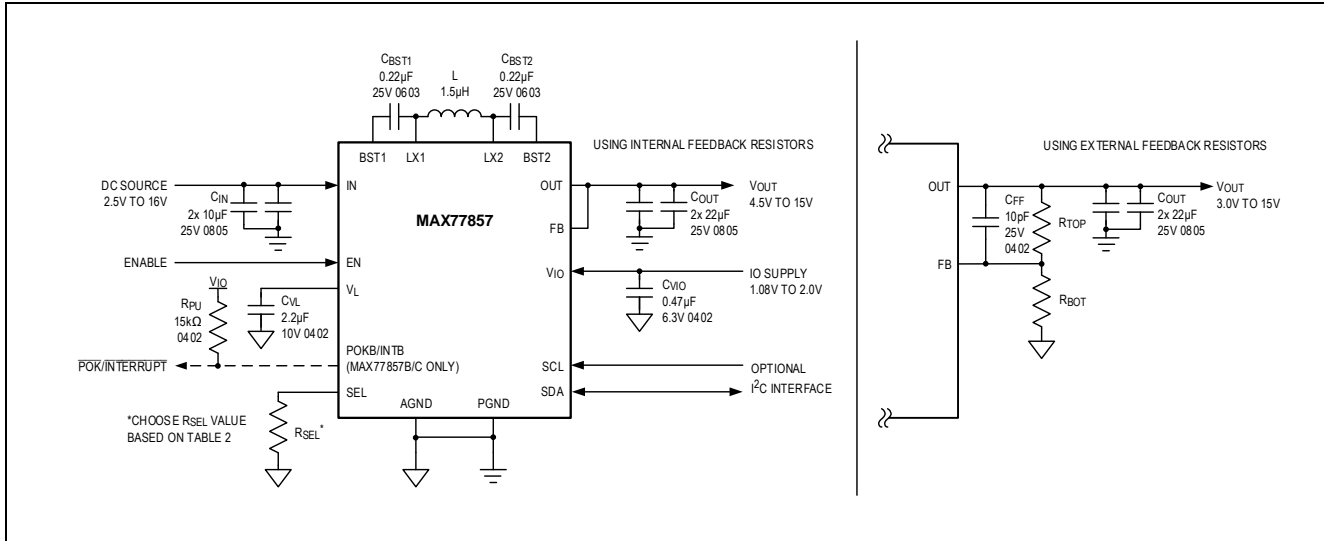

Figure 1. MAX77857 Typical Application Circuit

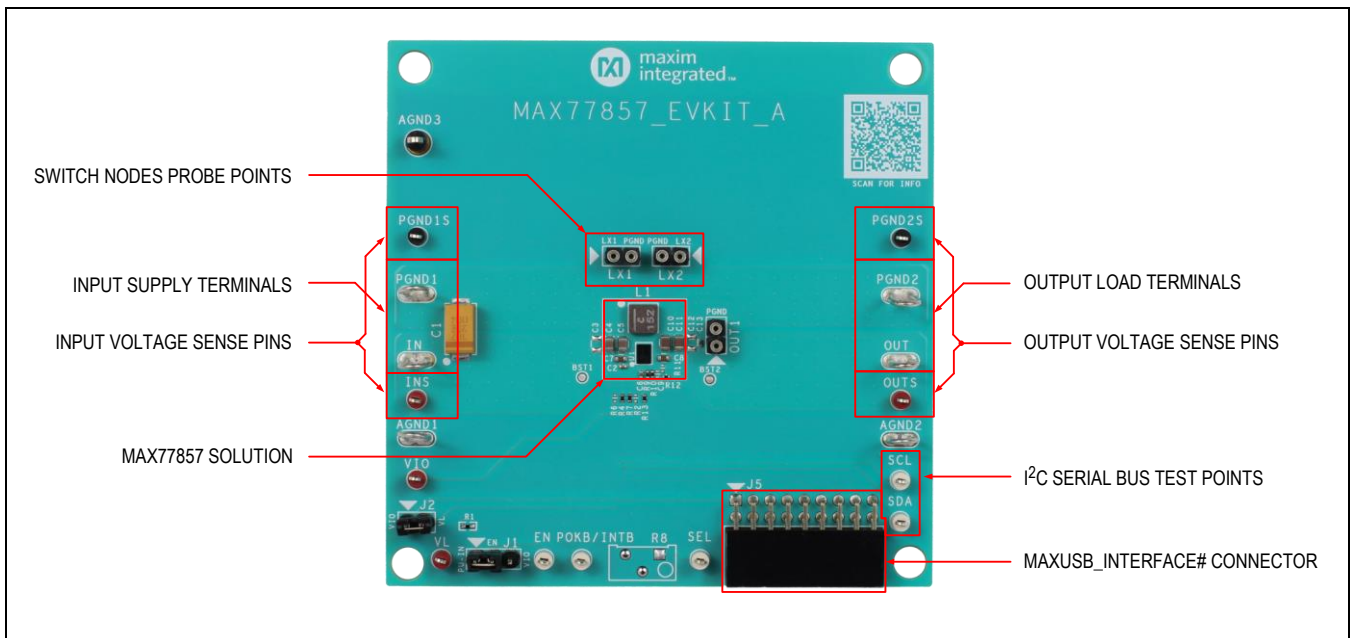

Figure 2. MAX77857 Evaluation Board

EV Kit Default Configuration

With the default jumper settings listed in [Table 1](#) and the EV kit component values of R_{SEL} (R9) = 0Ω , R_{TOP} (R10) = 0Ω , and R_{BOT} (R11) = OPEN, the MAX77857 EV kit is configured with the following settings:

- Internal Feedback
- Switching Current Limit = 7A
- I²C Slave Address (7-bit) = 0x66
- Switching Frequency = 1.8MHz (adjustable only through I²C)
- V_{IO} Disconnected from V_L
- EN Controlled from V_{IO} (as opposed to controlled from V_{IN})

See the [EV Kit Hardware](#) section to change the EV kit configuration.

Table 1. Default Shunt Positions and Jumper Descriptions

JUMPER	NODE	SHUNT POSITION	FUNCTION
J1	EN	1-2*	Connects EN to V _{IN} through a 510k Ω pullup resistor for standalone operation. See the Standalone Operation section for more information.
		2-3	Connects EN to V _{IO} . The converter is enabled when both V _{IN} and V _{IO} are valid.
		Not installed	Floats EN. Use for controlling EN from an external logic signal. The converter is disabled if no external logic signal is connected to EN.
J2	V _{IO}	1-2*	Connects V _{IO} to V _L . Allow V _{IO} to be powered from V _L without the need for a separate V _{IO} supply. See the Standalone Operation section for more information.
		Not installed	Disconnects V _{IO} from V _L . V _{IO} needs to be powered from either MAXUSB_INTERFACE# or an external V _{IO} supply.

*Default position

Quick Start

Required Equipment

- MAX77857 EV Kit
- Adjustable DC power supply
- Digital multi-meters
- Electronic load
- MAXUSB_INTERFACE# for I²C serial interface (optional)
- USB Type-A to Micro-USB cable (optional)
- Windows-based PC with MAX77857 EV kit GUI (optional)

Setup Overview

Typical bench setups for the MAX77857 EV kit with different configurations are shown in [Figure 3](#), [Figure 4](#), and [Figure 5](#).

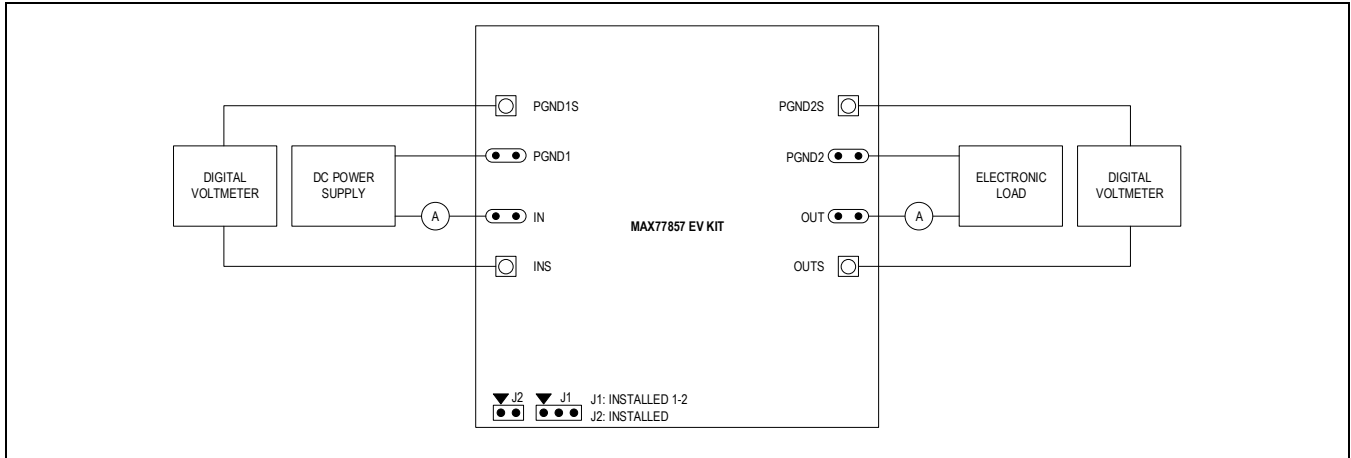

Figure 3. EV Kit Connection Block Diagram—Standalone Operation

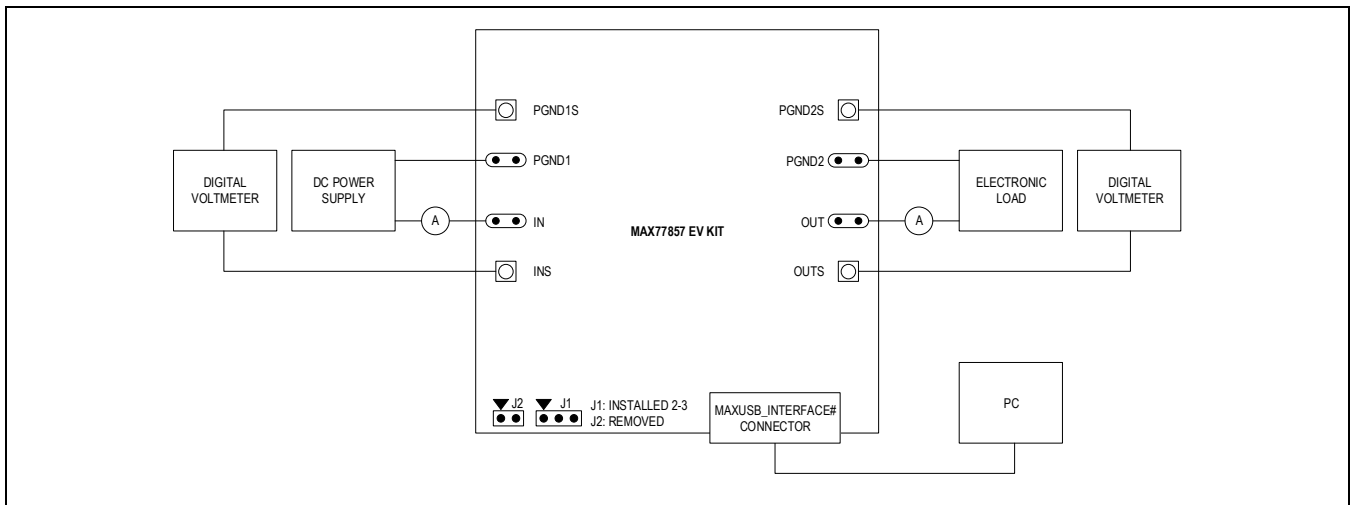

Figure 4. EV Kit Connection Block Diagram—with MAXUSB_INTERFACE#

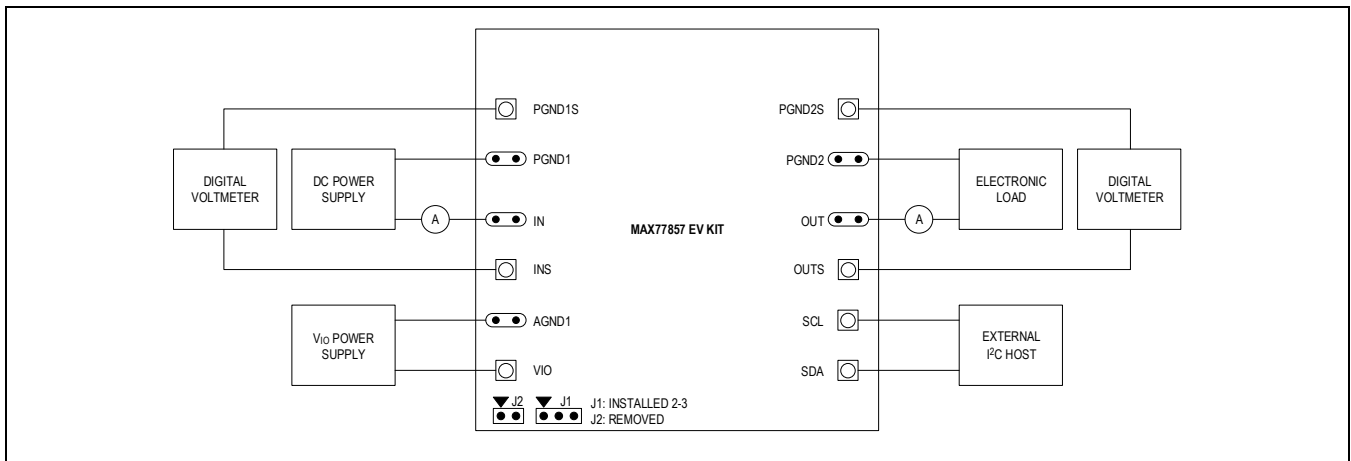

Figure 5. EV Kit Connection Block Diagram—with External I²C Bus

Procedure

The EV kit is fully assembled and tested. Perform the following steps to verify board operation. Use twisted wires of appropriate gauge (20 AWG) that are as short as possible to connect the load and power sources.

Note: In the following sections, software-related items are identified by bolding. Text in **bold** refers to items directly from the evaluation software. Text in **bold and underlined** refers to items from the Windows operating system.

1. Ensure the EV kit has the correct jumper settings, as shown in [Table 1](#).
2. Connect a voltmeter (DVM1) to INS and PGND1S sense pins to measure input voltage.
3. Connect a voltmeter (DVM2) to OUTS and PGND2S sense pins to measure the output voltage.
4. Apply a power supply set to 0V (1.5A current limit) through an ammeter across the IN and PGND1 terminals of the EV kit. Turn the power supply on and increase the voltage to 7.6V.
5. Confirm the DVM2 reads the default output voltage of the EV kit (5V). Confirm the ammeter reads the expected input supply current (about 12mA).
6. Now that the EV kit is confirmed working, short out the series ammeter and increase the power supply's current limit. Connect an electronic load across OUT and PGND2 terminals to evaluate the performance of the MAX77857 buck-boost regulator.

The next steps in the procedure use the EV kit GUI and MAXUSB_INTERFACE# to evaluate the MAX77857's I²C serial interface. If such evaluation is not required, you may skip the following steps. The EV kit includes on-board 2.2k Ω pullup resistors (R4 and R7) to V_{IO} for I²C serial interface signals SDA and SCL.

7. Install GUI software. Visit the product webpage at <https://www.maximintegrated.com/products/MAX77857WEVKIT> and navigate to *Design Resources* to download the latest version of the EV kit software. Save the EV kit software installation file to a temporary folder and decompress the ZIP file. Run the .EXE installer and follow the on-screen instructions to complete the installation.
8. Turn off the input power supply connected in step 4.
9. Remove jumper J2. V_{IO} is later powered from MAXUSB_INTERFACE#'s on-board LDO. Move jumper J1 to position 2-3.
10. Ensure SW1 and SW2 switches on the MAXUSB_INTERFACE# are set to the ON position. This enables I²C mode on the MAXUSB_INTERFACE#.
11. **Important:** Ensure the V_L jumper on the MAXUSB_INTERFACE# (J5) is set to 1.8V. This sets the MAXUSB_INTERFACE#'s V_{IO} voltage. Setting this incorrectly to 3.3V could potentially damage the MAX77857 IC.
12. Connect the MAXUSB_INTERFACE# to the EV kit. Connect the MAXUSB_INTERFACE# to your PC's USB port using a USB Type-A to Micro-USB cable.
13. Turn on the input power supply.
14. On the PC, open the GUI and click the **Device** button in the menu bar. Click the **Connect** button in the **Device** button's drop-down list. Wait for the device to respond, and in the **Synchronize** window, press the **Connect and Read** button.
15. Drag the slider bar in the [Output Voltage Configuration](#) section to change the output voltage and click **Write**.
16. Confirm on DVM2 that the software command to change output voltage was successful. If so, the I²C serial interface is confirmed working.

This concludes the Quick Start procedure. Users are now encouraged to further explore the device and its register settings with the GUI software. For more information about the GUI, see the [EV Kit Software](#) section.

EV Kit Hardware

The MAX77857 EV kit demonstrates the MAX77857 buck-boost regulator. It regulates output from input voltage ranges from 2.5V to 16V. The programmable output range is from 4.5V to 15V with internal feedback resistors, or from 3V to 15V with external feedback resistors. The EV kit is suited with a general DC input. [Table 1](#) lists jumpers and associated functions that are available on the EV kit.

Standalone Operation

The MAX77857 is capable of standalone operation, in which the IC starts up whenever V_{IN} and EN are valid, and it does not require a separate supply for the V_{IO} pin. This is useful for systems without a host controller or if the MAX77857 is the only power supply in the system. To configure the MAX77857 EV kit for standalone operation, install header jumper

J1 to position 1-2. This connects EN to V_{IN} through a 510k Ω pullup resistor so that EN is controlled by V_{IN} . Also, install header jumper J2. This connects V_{IO} to V_L so that V_{IO} is powered from V_L , eliminating the need for an external V_{IO} power supply.

MAXUSB_INTERFACE#

The MAXUSB_INTERFACE# along with the companion EV kit GUI software allows users to easily change the MAX77857's register settings with a Windows PC. Before connecting the MAXUSB_INTERFACE# to the EV kit's MAXUSB_INTERFACE# connector (J5), make sure the MAXUSB_INTERFACE# is configured with the following settings:

- SW1, SW2 to ON Position (This enables I²C mode on the MAXUSB_INTERFACE#.)
- V_L Jumper (J5) to 1.8V (This sets the MAXUSB_INTERFACE#'s V_{IO} voltage.)
 - **Warning:** Setting this incorrectly to 3.3V could potentially damage the MAX77857 IC.

The MAXUSB_INTERFACE# also includes an on-board LDO that can supply the necessary voltage to V_{IO} . If you are using the MAXUSB_INTERFACE#, disconnect any external V_{IO} supply from the EV kit, and make sure header jumper J2 is removed from the EV kit.

External I²C Bus

If you wish to connect to the external I²C serial bus and not use the MAXUSB_INTERFACE#, unplug the MAXUSB_INTERFACE# from the EV kit's MAXUSB_INTERFACE# connector (J5). Apply an external I/O supply to the V_{IO} pin or power the V_{IO} pin from the V_L pin by connecting header jumper J2. Make sure the external I²C serial bus's logic voltage level is compatible with the MAX77857's I/O logic voltage level. Refer to the MAX77857 IC data sheet for the appropriate I/O logic voltage level.

R_{SEL} Configuration Resistor

The MAX77857 includes an SEL pin to set the I²C slave address, switching current limit, and feedback configuration. A resistor with 1% tolerance (or better) should be chosen for R_{SEL} (R9). The default R_{SEL} value installed on the EV kit is 0 Ω . See [Table 2](#) for nominal R_{SEL} values and their corresponding settings. The switching current limit is also adjustable dynamically through the I²C serial interface when the IC is enabled. See the [EV Kit Software](#) section for more information.

Table 2. MAX77857 R_{SEL} Selection Table

R _{SEL} (Ω)	FEEDBACK RESISTOR SELECTION	TYPICAL I _{LIM} (A)	I ² C SLAVE ADDRESS (7-BIT)	R _{SEL} (Ω)	FEEDBACK RESISTOR SELECTION	TYPICAL I _{LIM} (A)	I ² C SLAVE ADDRESS (7-BIT)
0*	Internal feedback resistors	7.0	110 0110 (0x66)	3740	External feedback resistors	7.0	110 0110 (0x66)
200			110 0111 (0x67)	8060			110 0111 (0x67)
309			110 1110 (0x6E)	12400			110 1110 (0x6E)
422			110 1111 (0x6F)	16900			110 1111 (0x6F)
536		5.6	110 0110 (0x66)	21500		5.6	110 0110 (0x66)
649			110 0111 (0x67)	26100			110 0111 (0x67)
768			110 1110 (0x6E)	30900			110 1110 (0x6E)
909			110 1111 (0x6F)	36500			110 1111 (0x6F)
1050		3.8	110 0110 (0x66)	42200		3.8	110 0110 (0x66)
1210			110 0111 (0x67)	48700			110 0111 (0x67)
1400			110 1110 (0x6E)	56200			110 1110 (0x6E)
1620			110 1111 (0x6F)	64900			110 1111 (0x6F)
1870		1.8	110 0110 (0x66)	75000		1.8	110 0110 (0x66)
2150			110 0111 (0x67)	86600			110 0111 (0x67)
2490			110 1110 (0x6E)	100000			110 1110 (0x6E)
2870			110 1111 (0x6F)	OPEN			110 1111 (0x6F)

*Default value installed on the EV Kit

Output Voltage Configuration

By default, the EV kit is configured to use internal feedback resistors, with a 5V default startup output voltage and an output voltage range from 4.5V to 15V. To achieve a different default startup output voltage other than 5V, or to achieve a lower minimum output voltage range down to 3V, external feedback resistors are required. To change the EV kit to external feedback configuration, replace the feedback resistor R_{TOP} (R10) and R_{BOT} (R11) with appropriate value resistors (use resistors with 1% tolerance or better) and adjust R_{SEL} (R9) accordingly to select the external feedback option. It is also recommended to install a 10pF feed-forward capacitor on C9 when using external feedback.

To select appropriate external feedback resistor values, first chose R_{TOP} (R10) to be between 150k Ω and 330k Ω . Then calculate the value of R_{BOT} (R11) for a desired startup output voltage with the following equation:

$$R_{BOT} = \frac{R_{TOP} \times V_{REF}}{V_{OUT} - V_{REF}}$$

Where V_{REF} is 0.333V and V_{OUT} is the desired startup output voltage. Note that the output voltage cannot exceed the maximum output voltage of 15V. The recommended external feedback resistor values for common output voltages are listed in [Table 3](#).

After startup, the output voltage can be adjusted dynamically using the I²C serial interface. See the [EV Kit Software](#) section for more information. When using internal feedback, output voltage ranges are between 4.5V and 15V in 73.5mV steps. When using external feedback, output voltage range and step size vary based on the external feedback resistor values. To calculate output voltage range, use the following equation and plug in the minimum V_{REF} of 0.299V and maximum V_{REF} of 1V:

$$V_{OUT} = \frac{V_{REF}}{R_{BOT}} \times (R_{BOT} + R_{TOP})$$

Output voltage step size can be calculated with the following equation:

$$V_{OUT_STEP} = \frac{4.9mV}{R_{BOT}} \times (R_{BOT} + R_{TOP})$$

Programmable output voltage ranges and output voltage step sizes for each recommended feedback resistor pairs are listed in [Table 3](#).

Table 3. Feedback Resistor Value Recommendations

DEFAULT V_{REF} (V)	R_{TOP} R10 (k Ω)	R_{BOT} R11 (k Ω)	STARTUP V_{OUT} (V)	PROGRAMMABLE V_{OUT} RANGE (V)	V_{OUT} STEP SIZE (mV)
0.333	160	20	3	3.0 to 9.0	44.1
	178	20	3.3	3.0 to 9.9	48.5
	Internal feedback resistors*		5	4.5 to 15	73.5
	312	12	9	8.1 to 15	132.3
	232	6.65	12	10.7 to 15	175.8
	234	5.3	15	13.5 to 15	221.2

*Default EV kit configuration

High-Temperature Testing

The MAX77857 is rated for operation under junction temperatures up to +125°C. Note that not all components on the EV kit are rated for temperatures this high. Some ceramic capacitors experience extra leakage when put under temperatures higher than they are rated for and supply current readings for the IC might be larger than expected. The MAXUSB_INTERFACE# is also not rated for +125°C. Double-check the components on the EV kit if testing at +125°C ambient or junction temperatures. Consider replacing these components if IC operation at +125°C ambient or junction temperature is an important use case.

List of capacitors not rated for +125°C: C10, C11 (OUT capacitors)

Critical Node Measurement (OUT and LX)

The EV kit comes with probe points for measuring critical nodes OUT1, LX1, and LX2. See [Figure 2](#) for their locations on the EV kit. Use these probe points to eliminate as much noise as possible when measuring the critical nodes. To ensure the best results, use a very short ground wire from the ground sleeve of the scope probe to the GND side of the probe point, and use the bare tip of the probe directly to the signal side of the probe point ([Figure 6](#)). Following these guidelines gives the most accurate results when measuring parameters such as output voltage ripple, switching waveforms, and load transient response.

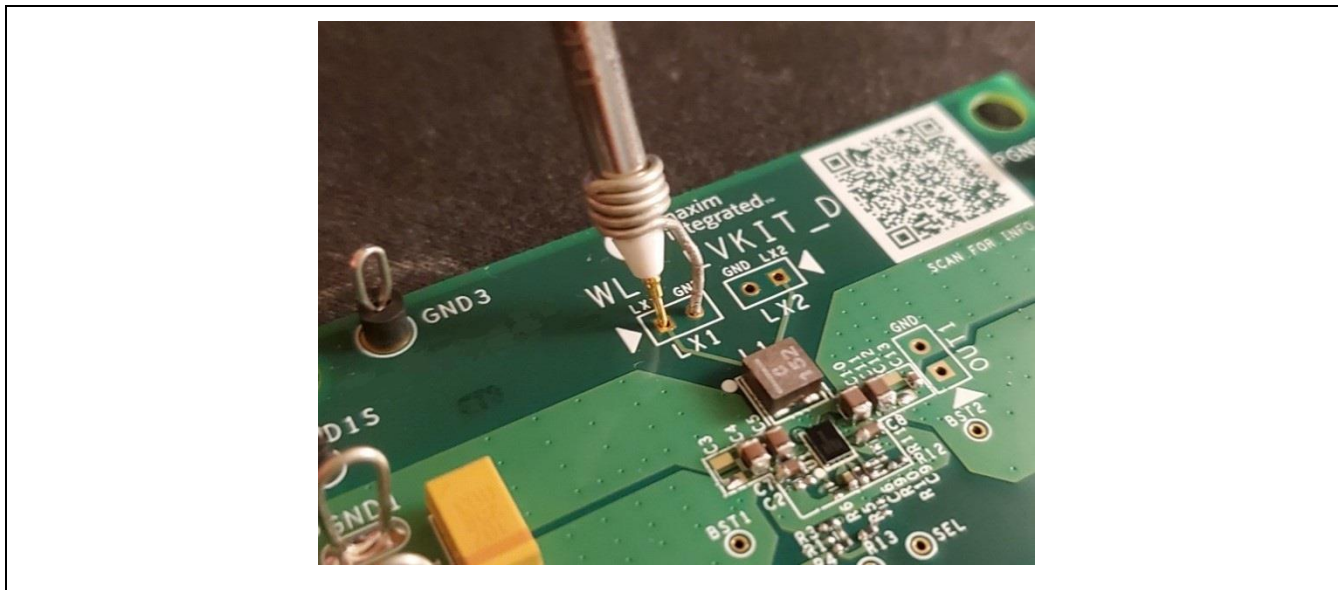

Figure 6. Probing Critical Nodes

Efficiency Measurement (INS and OUTS)

The EV kit also comes with sense pins for accurately measuring input voltage (INS, PGND1S) and output voltage (OUTS, PGND2S). See [Figure 2](#) for their locations on the EV kit. For most accurate efficiency, load regulation, and line regulation measurements, use these sense pins to measure input and output voltages.

Warning: These sense pins are only for measuring voltages. Do not connect input supply to input sense pins and do not connect an electronic load to output sense pins, as these sense pins are not designed to have current running through them. Doing so damages the EV kit. Use input supply terminals for connecting to input supply and use output terminals for connecting to electronic load as shown in [Figure 2](#).

Table 4. Usage of Critical Test Points

LOAD TRANSIENT, OUTPUT RIPPLE	LOAD REGULATION, LINE REGULATION, V _{OUT} ACCURACY	EFFICIENCY		SWITCHING NODE	
		OUTPUT VOLTAGE	INPUT VOLTAGE	LX1	LX2
V _{OUT} (OUT1)	V _{OUT} (OUTS, PGND2S)	V _{OUT} (OUTS, PGND2S)	V _{IN} (INS, PGND1S)	LX1 (LX1)	LX2 (LX2)

EV Kit Software

The graphical user interface (GUI) software allows for a quick, easy, and thorough evaluation of the MAX77857. The GUI along with the MAXUSB_INTERFACE# drives I²C communication with the EV kit. Every control in the GUI corresponds directly to a register within the MAX77857. Refer to the *Register Map* section of the MAX77857 IC data sheet for a complete description of the registers. See [Figure 7](#) for a screenshot of the GUI upon first opening.

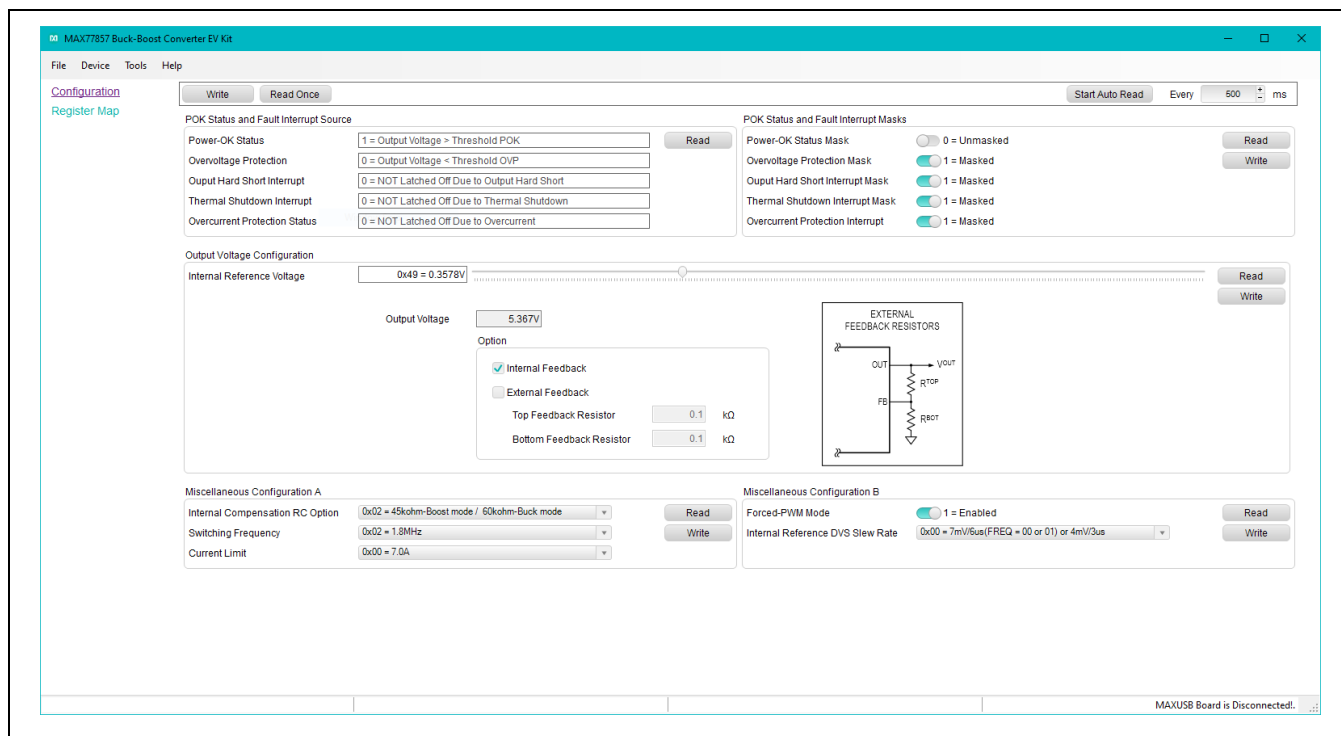

Figure 7. MAX77857 EV Kit GUI Software Configuration Tab

Installation

Visit the product webpage at <https://www.maximintegrated.com/products/MAX77857WEVKIT> and navigate to *Design Resources* to download the latest version of the EV kit software. Save the EV kit software installation file to a temporary folder and decompress the ZIP file. Run the .EXE installer and follow the on-screen instructions to complete the installation.

Windows Driver

After plugging in the MAXUSB_INTERFACE# to the PC with a Micro-USB cable for the first time, wait about 30 seconds for Windows to automatically install the necessary drivers.

Connecting the GUI to MAXUSB_INTERFACE#

After opening the GUI, click **Device** in the upper left corner of the GUI window. Click **Connect** in the drop-down menu. If you have multiple MAXUSB_INTERFACE# adapters or FTDI devices connected to your PC, the **Port Synchronization** menu appears ([Figure 8](#)). Select the port corresponding to the MAXUSB_INTERFACE# attached to the MAX77857 EV kit and click **Connect**.

The **Device Synchronization** menu opens ([Figure 9](#)) once the MAX77857 IC responds (voltages on the IN and V_{IO} pins must be valid on the MAX77857 IC for it to respond). The I²C address shown is the MAX77857 ICs 7-bit slave address. The address shown changes depending on the EV kit's R_{SEL} configuration. See the EV Kit Hardware [R_{SEL} Configuration Resistor](#) section if you wish to change the address. Click **Connect and Read**. The text at the bottom right of the GUI window changes from "MAXUSB is Disconnected" to "MAXUSB is Connected."

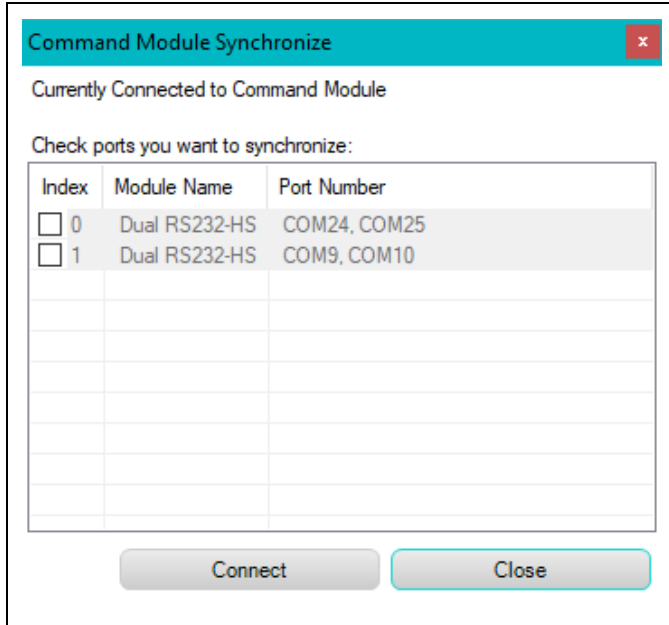

Figure 8. Port Synchronization Menu

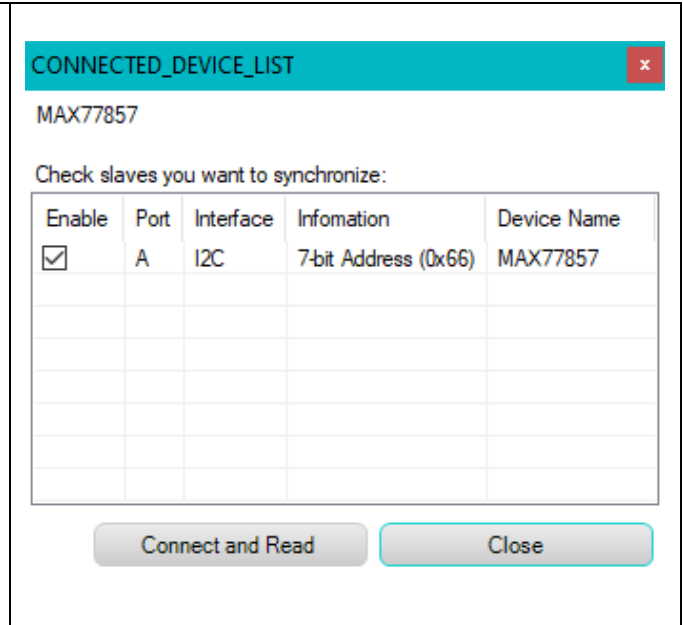

Figure 9. Device Synchronization Menu

Configuration

The **Configuration** tab (Figure 7) displays information and status of the IC on the EV Kit as well as all available register settings. It is divided into different sections: POK Status and Fault Interrupts, Output Voltage Configuration, and Miscellaneous Configuration.

Click **Read Once** located on the top of the GUI window to obtain all setting values currently stored on all the MAX77857's registers. After changing the setting values in the GUI software, click **Write** on the top of the GUI window to apply all settings to the MAX77857's registers. Alternatively, click **Read** on each setting section to obtain the setting values of that particular section currently stored on the MAX77857's registers. After changing the setting values in the GUI software, click **Write** in the corresponding setting section to apply the new settings for that particular section to the MAX77857's registers.

The **POK Status and Fault Interrupt Source** section (Figure 10) displays the power-OK status and any fault conditions detected on the MAX77857 IC, which are stored in the INT_SRC register. Periodically check the **POK Status and Fault Interrupt Source** section during evaluation to monitor the status of power-OK (POK), overvoltage protection (OVP), output hard-short, thermal shutdown (THS), and overcurrent protection (OCP). Click **Read** to obtain the latest status from the IC.

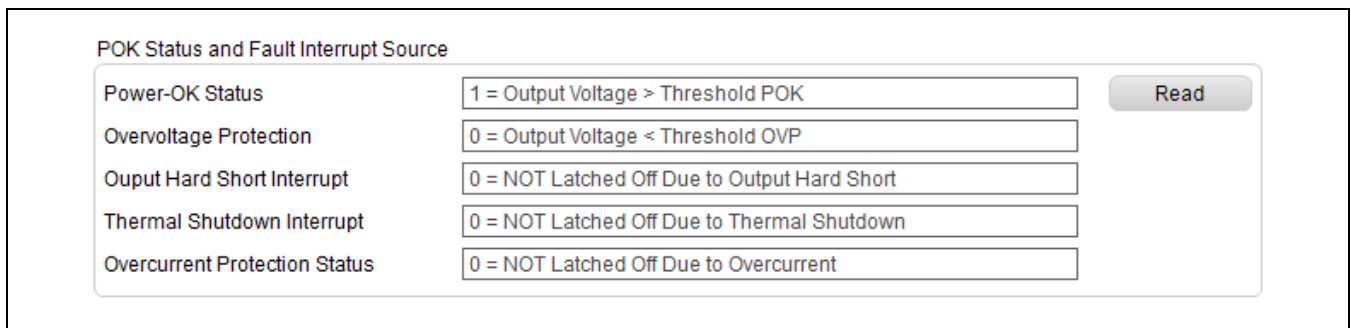

Figure 10. Configuration Tab—POK Status and Fault Interrupt Source Section

The **POK Status and Fault Interrupt Masks** section ([Figure 11](#)) configures the reflection of the bits in INT_SRC to the POKB/INTB pin. If a bit is masked, its status in the INT_SRC register is not shown on the POKB/INTB pin. Refer to the *Power-OK Monitor and Fault Interrupts* section in the IC data sheet for more information about the operation of the POKB/INTB pin. Click **Read** to obtain the setting stored on the IC and click **Write** to apply new settings to the IC.

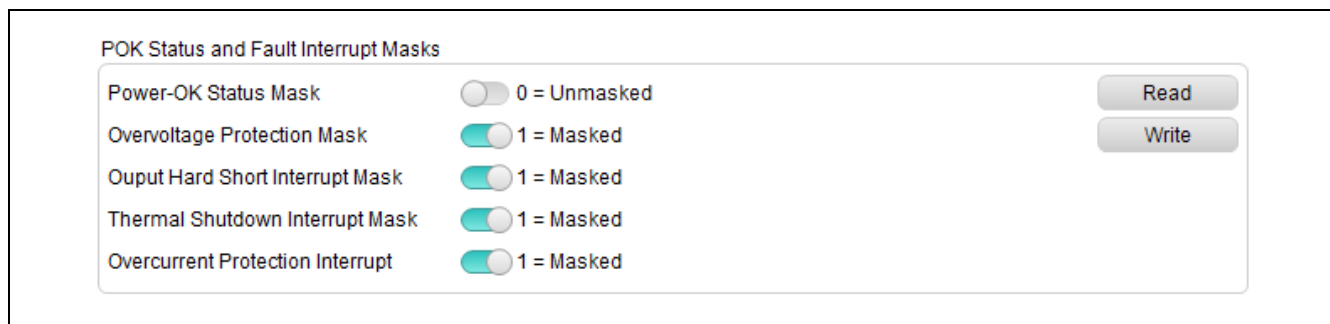

Figure 11. Configuration Tab—POK Status and Fault Interrupt Masks Section

The **Output Voltage Configuration** section ([Figure 12](#)) configures the EV kit ICs output voltage. The output voltage is changed by adjusting the internal reference voltage. Drag the slider to the desired internal reference voltage (or output voltage) and click **Write** to change the output voltage. Clicking **Read** returns the programmed internal reference voltage (or output voltage) to the GUI.

To make evaluation easier, the GUI software displays the corresponding output voltage value in the **Output Voltage** textbox based on the value in the **Internal Reference Voltage** slider. To obtain the correct value, check the **Internal Feedback** or **External Feedback** checkbox corresponding to the EV kit configuration. For external feedback configuration, enter the chosen feedback resistor values in the **Top Feedback Resistor** and **Bottom Feedback Resistor** text boxes to allow the correct calculation of the corresponding output voltage to be displayed on the GUI software.

Note: Changing the **Internal Feedback** or **External Feedback** checkboxes ([Figure 12](#)) does NOT change the feedback configuration on the EV kit. It is only for calculating and displaying the correct output voltage value on the GUI software. If you wish to change the EV kit's feedback configuration, see the EV Kit Hardware [Output Voltage Configuration](#) section for details.

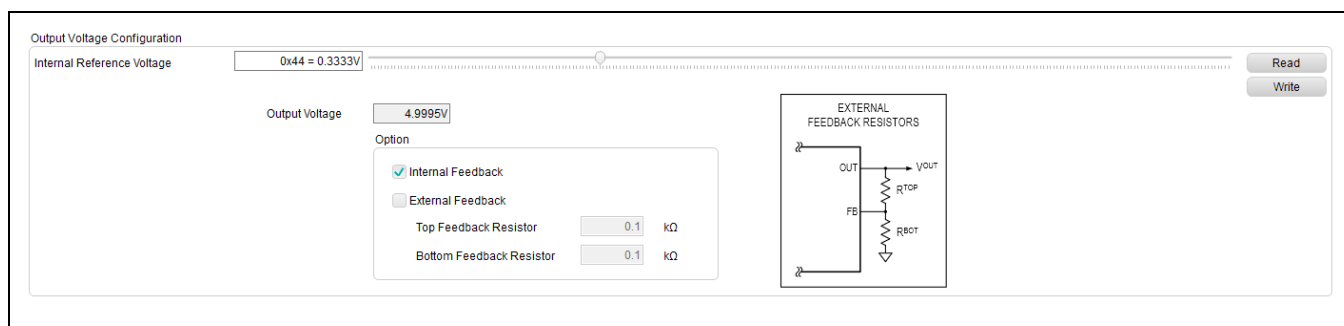

Figure 12. Configuration Tab—Output Voltage Configuration Section

The **Miscellaneous Configuration** sections ([Figure 13](#)) show the remaining register settings of the MAX77857. Use these sections to control internal compensation resistance, switching frequency, switching current limit, forced-PWM mode, and output voltage change slew rate (using the internal reference voltage DVS slew rate). Refer to the *MAX77857* IC data sheet for more information on each available setting. Click **Read** to obtain the setting stored on the IC and click **Write** to apply new settings to the IC.

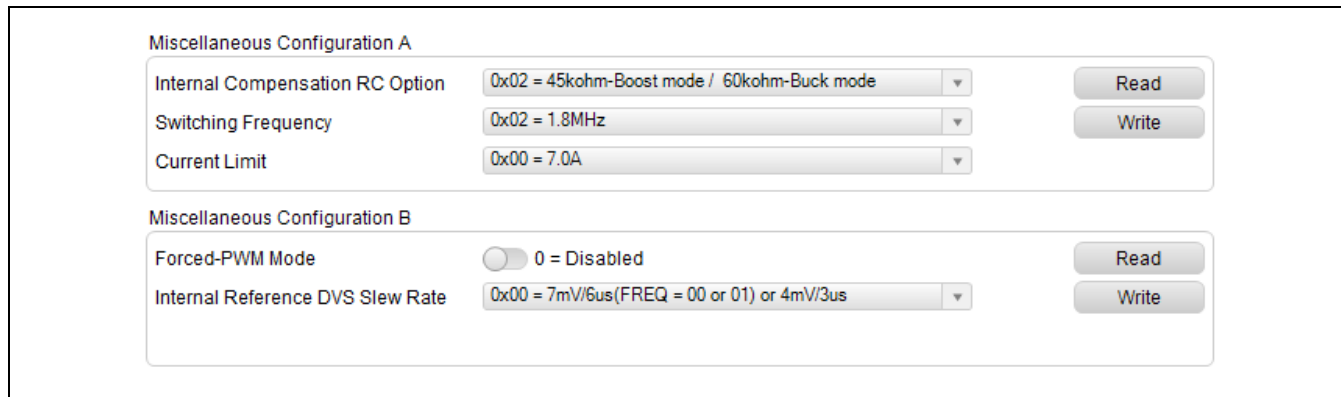

Figure 13. Configuration Tab—Miscellaneous Configuration Sections

Register Map

The **Register Map** tab provides an overview of all the MAX77857 registers and the values currently stored on them. Clicking on an individual bit shows the name and description of the specific bitfield.

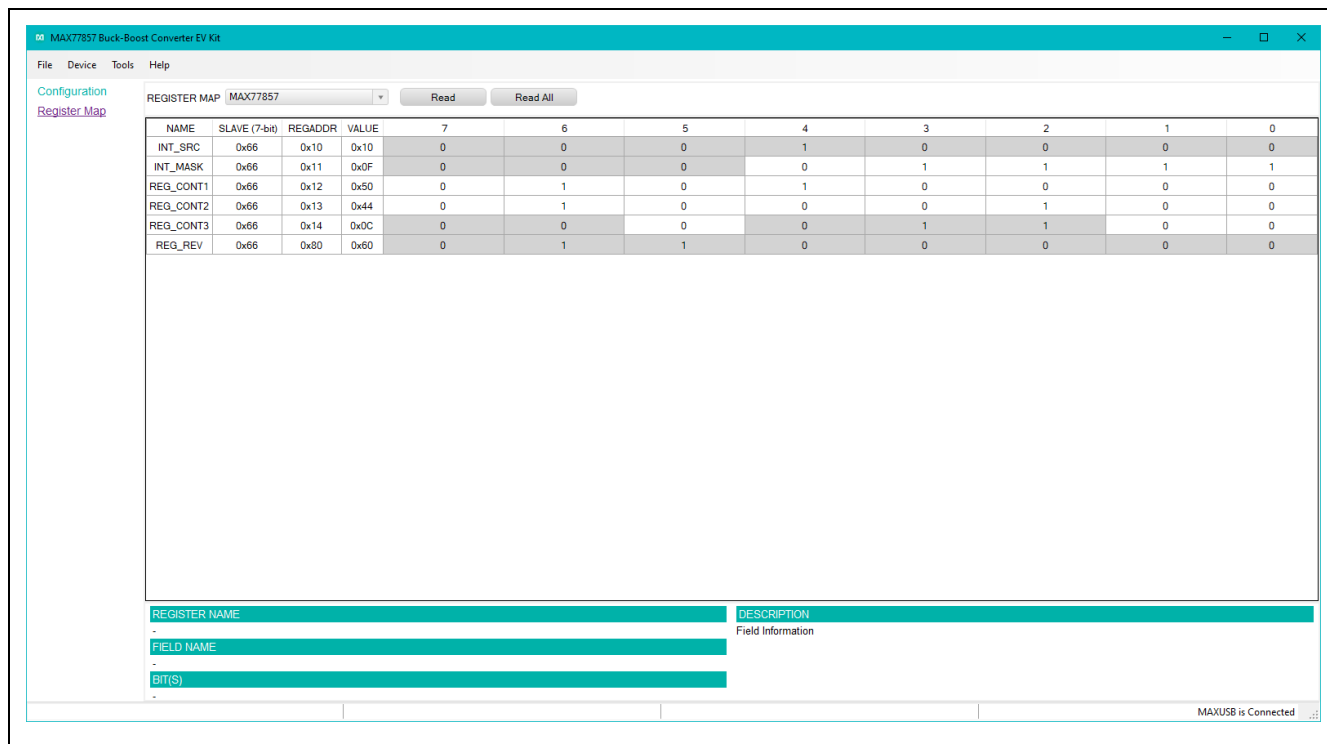

Figure 14. EV Kit GUI Software Register Map Tab

Layout Guideline

Careful circuit board layout is critical to achieving low switching power losses and clean, stable operation. The EV kit also serves as a Maxim recommended layout of the MAX77857. If POK or fault interrupt functionality is desired, then high-density interconnect (HDI) PCB is required to route to the POKB/INTB pin. Otherwise, HDI PCB is recommended but not required. [Figure 15](#), [Figure 16](#), and [Figure 17](#) show examples of non-HDI and HDI PCB layouts for the MAX77857 WLP package. Use the provided layout files for guidance when designing with the IC. The IC data sheet contains a list of useful tips and guidelines for achieving the best possible layout. They are repeated here for convenience:

- Place the input capacitors (C_{IN}) and output capacitors (C_{OUT}) immediately next to the IN pin and OUT pin of the IC, respectively. Since the IC operates at a high switching frequency, this placement is critical for minimizing parasitic inductance within the input and output current loops, which can cause high voltage spikes and can damage the internal switching MOSFETs.
- Place the inductor next to the LX bumps (as close as possible) and make the traces between the LX bumps and the inductor short and wide to minimize PCB trace impedance. Excessive PCB impedance reduces converter efficiency. When routing LX traces on a separate layer (as in the examples), make sure to include enough vias to minimize trace impedance. Routing LX traces on multiple layers is recommended to further reduce trace impedance. Furthermore, do not let LX traces take up an excessive amount of area. The voltage on this node switches very quickly and an additional area creates more radiated emissions.
- Route LX nodes to their corresponding bootstrap capacitor (C_{BST}) as short as possible. Prioritize C_{BST} placement to reduce trace length to the IC.
- Connect the inner PGND bumps to the low-impedance ground plane on the PCB with vias placed next to the bumps. Do not create PGND islands, as PGND islands risk interrupting the hot loops. Connect AGND and AGND island to the low-impedance ground plane on the PCB (the same net as PGND).
- Keep the power traces and load connections short and wide. This is essential for high converter efficiency.
- Do not neglect ceramic capacitor DC voltage derating. Choose capacitor values and case sizes carefully. Refer to the *Output Capacitor Selection* section in the MAX77857 IC data sheet and [Tutorial 5527](#) for more information.

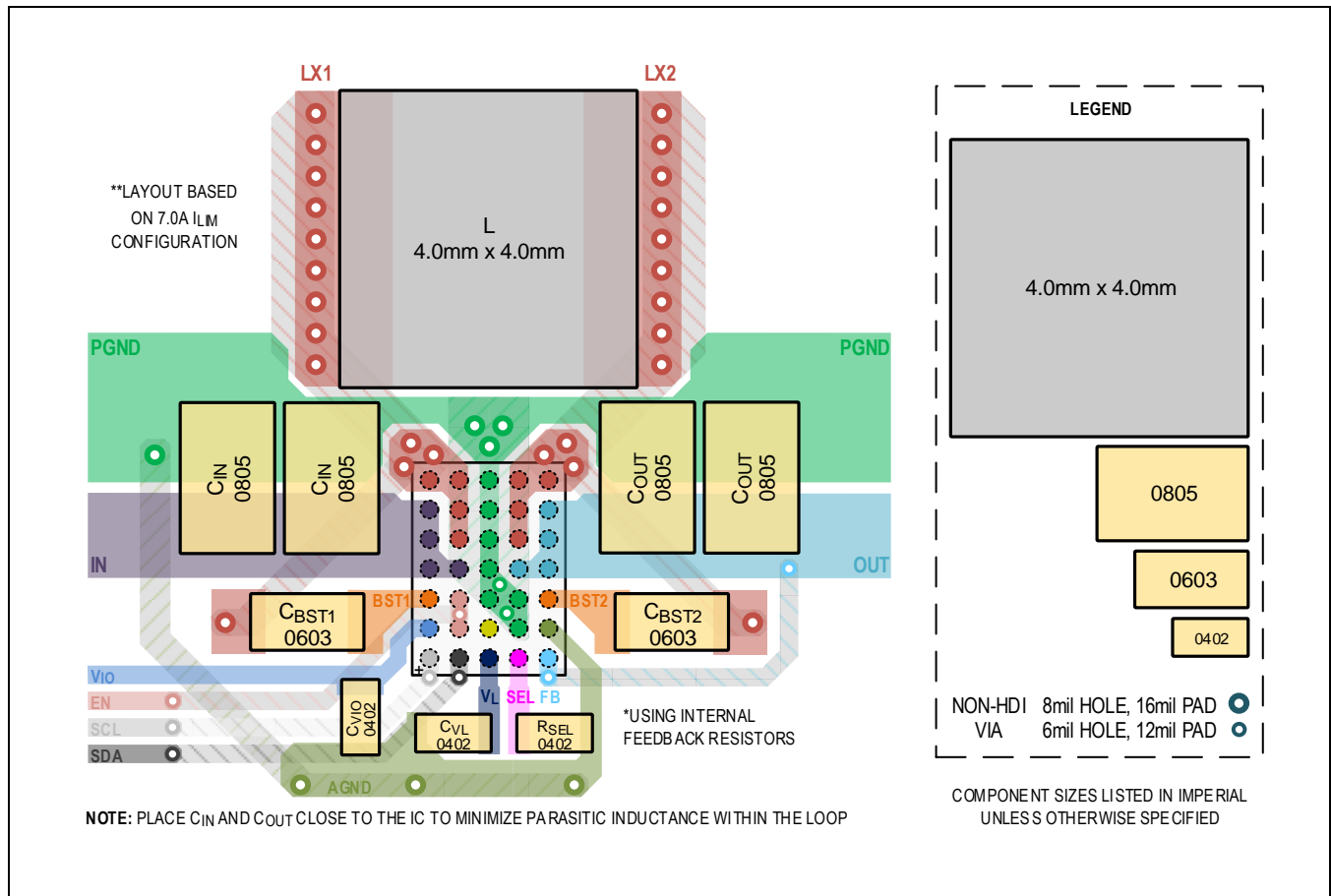

Figure 15. Non-HDI PCB Layout Recommendation for 35 WLP Package with 4mm x 4mm Inductor

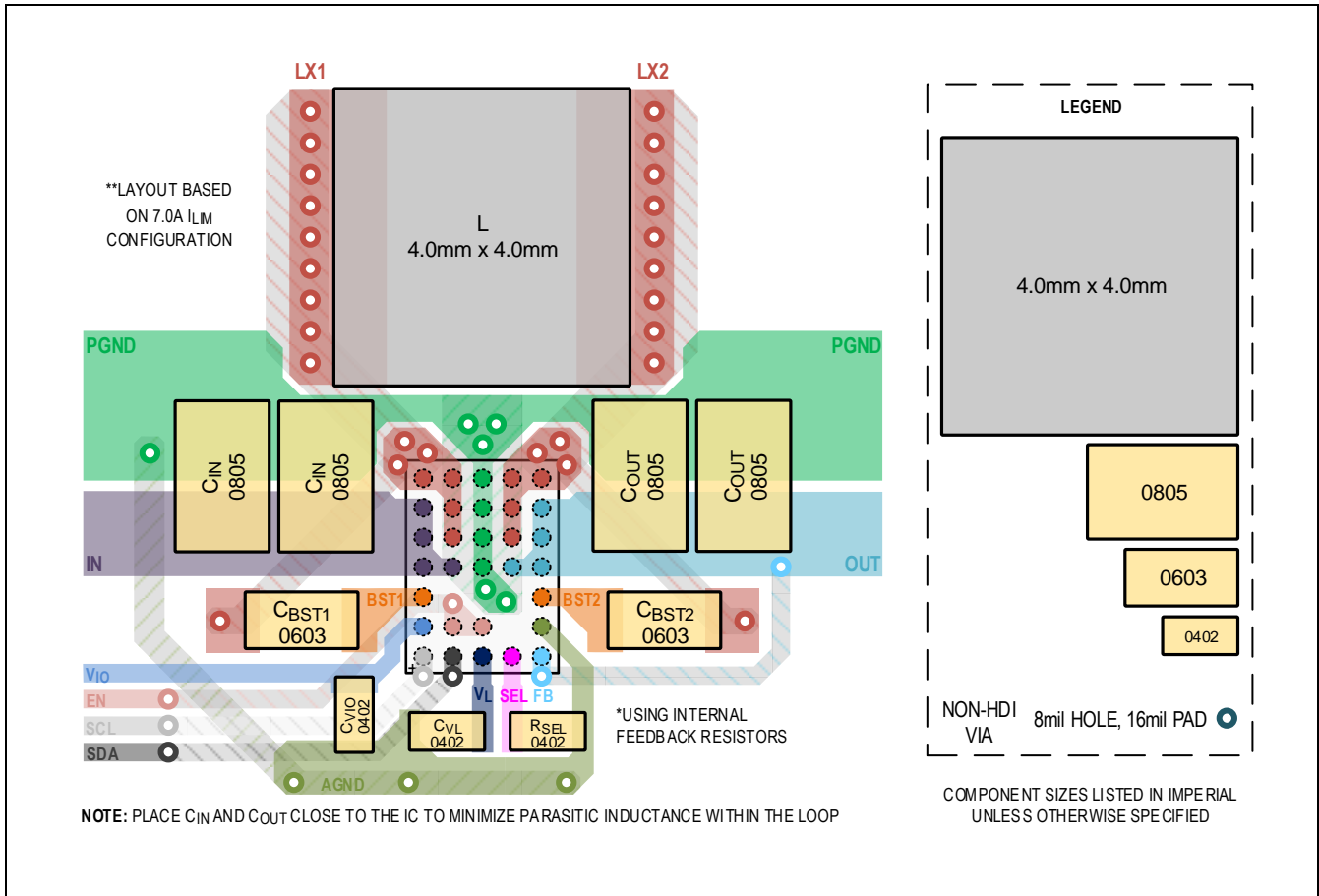

Figure 16. Non-HDI PCB Layout Recommendation for 31 WLP Package with 4mm x 4mm Inductor

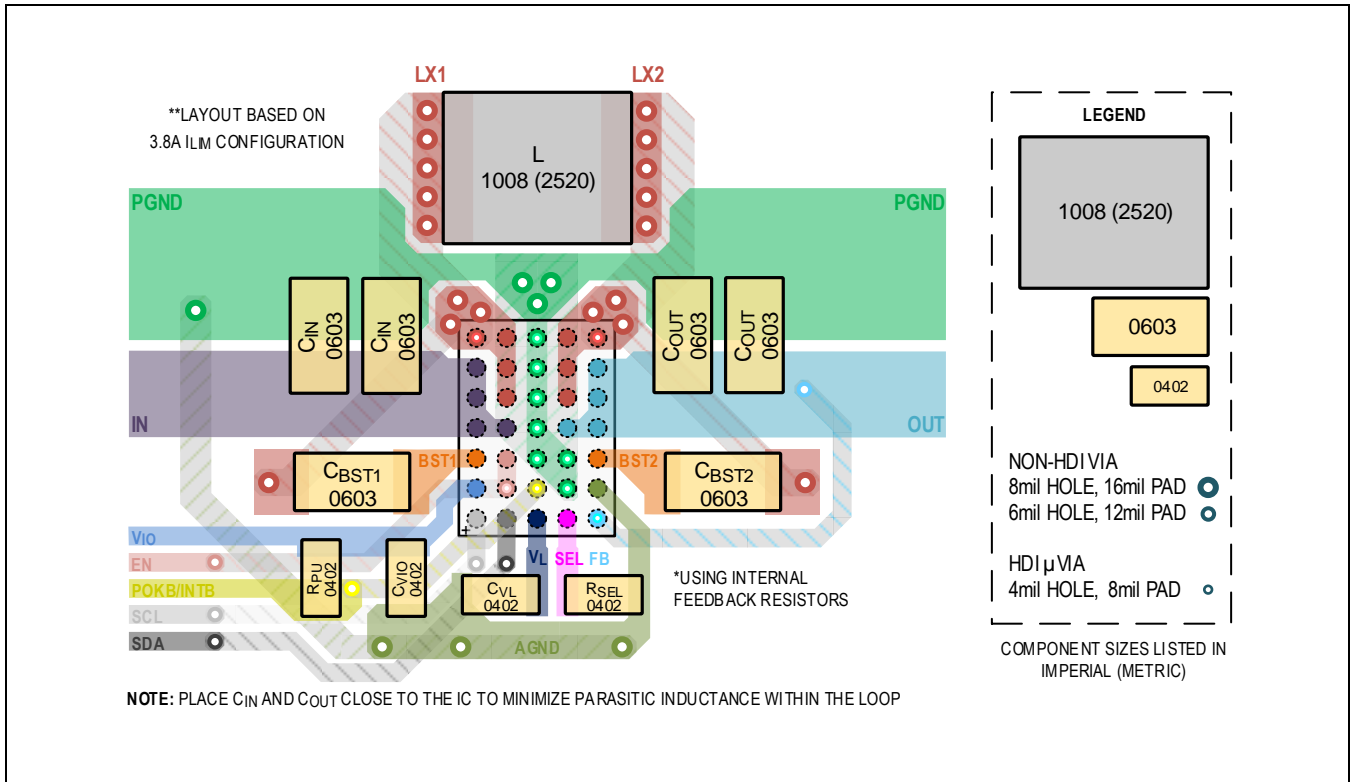

Figure 17. HDI PCB Layout Recommendation for 35 WLP Package with POKB/INTB and 2520 Inductor

Ordering Information

PART	U1 IC	DEFAULT OUTPUT VOLTAGE	TYPE
MAX77857WEVKIT#	MAX77857BEWB+T	5V	EV Kit

#Denotes RoHS-compliant device that may include lead that is exempt under the RoHS requirements.

+Denotes a lead(Pb)-free/RoHS-compliant package.

MAX77857 EV Kit Bill of Materials

PART	QTY	MFG PART #	MANUFACTURER	VALUE	DESCRIPTION
C2	1	JMK105B7474KVHF	TAIYO YUDEN	0.47UF	CAP; SMT (0402); 0.47UF; 10%; 6.3V; X7R; CERAMIC
C4, C5	2	GRM21BC71E106KE11	MURATA	10UF	CAP; SMT (0805); 10UF; 10%; 25V; X7S; CERAMIC
C6	1	C1005X7S0J225K050BC; GRM155C70J225KE11	TDK;MURATA	2.2UF	CAP; SMT (0402); 2.2UF; 10%; 6.3V; X7S; CERAMIC
C7, C8	2	GCJ188R71H224KA01	MURATA	0.22UF	CAP; SMT (0603); 0.22UF; 10%; 50V; X7R; CERAMIC
C10, C11	2	C2012X5R1E226M125AC; CL21A226MAQNNN	TDK;SAMSUNG ELECTRO- MECHANICS	22UF	CAP; SMT (0805); 22UF; 20%; 25V; X5R; CERAMIC
L1	1	XEL4020-152ME	COILCRAFT	1.5UH	INDUCTOR; SMT; COMPOSITE; 1.5UH; 20%; 7.5A
R9, R10, R12	3	ERJ-2GE0R00	PANASONIC	0	RES; SMT (0402); 0; JUMPER; JUMPER; 0.1000W
U1	1	MAX77857BEWB+	MAXIM	MAX77 857BE WB+	EVKIT PART - IC; MAX77857BEWB+; 2.5V TO 16V INPUT; 7A SWITCHING CURRENT HIGH EFFICIENCY BUCK- BOOST CONVERTER; PACKAGE OUTLINE DRAWING: 21-100367; PACKAGE CODE: W352A2+1; WLP35
C9	DNP	N/A	N/A	OPEN	CAPACITOR; SMT (0402); OPEN; FORMFACTOR
R11	DNP	N/A	N/A	OPEN	RESISTOR; 0402; OPEN; FORMFACTOR
Components below this line are outside of the immediate MAX77857 evaluation circuit and solution silkscreen.					
AGND1, AGND2, IN, OUT, PGND1, PGND2	6	9020 BUSS	WEICO WIRE	MAXIM PAD	EVK KIT PARTS; MAXIM PAD; WIRE; NATURAL; SOLID; WEICO WIRE; SOFT DRAWN BUS TYPE-S; 20AWG
AGND3	1	5011	KEYSTONE	N/A	TEST POINT; PIN DIA=0.125IN; TOTAL LENGTH=0.445IN; BOARD HOLE=0.063IN; BLACK; PHOSPHOR BRONZE WIRE SILVER PLATE FINISH;
ASSY1	1	MAXUSB_INTERFACE#	MAXIM	MAXU SB_IN TERFA CE#	EVKIT PART-MODULE; KIT; MAXUSB INTERFACE; DUAL-PORT USB-TO- SERIAL INTERFACE BOARD
C1	1	T491X107K025A	KEMET	100UF	CAP; SMT (7343-43); 100UF; 10%; 25V; TANTALUM
C13	1	GRM155R71E104KE14; C1005X7R1E104K050BB; TMK105B7104KVH; CGJ2B3X7R1E104K050BB	MURATA;TDK; TAIYO YUDEN;TDK	0.1UF	CAP; SMT (0402); 0.1UF; 10%; 25V; X7R; CERAMIC
EN, POKB/INTB, SCL, SDA, SEL	5	5002	KEYSTONE	N/A	TEST POINT; PIN DIA=0.1IN; TOTAL LENGTH=0.3IN; BOARD HOLE=0.04IN; WHITE; PHOSPHOR BRONZE WIRE SILVER;

INS, OUTS, VIO, VL	4	5000	KEYSTONE	N/A	TEST POINT; PIN DIA=0.1IN; TOTAL LENGTH=0.3IN; BOARD HOLE=0.04IN; RED; PHOSPHOR BRONZE WIRE SILVER PLATE FINISH;
J1	1	TSW-103-07-T-S	SAMTEC	TSW-103-07-T-S	CONNECTOR; THROUGH HOLE; TSW SERIES; SINGLE ROW; STRAIGHT; 3PINS
J2	1	PBC02SAAN	SULLINS ELECTRONICS CORP.	PBC02 SAAN	EVKIT PART-CONNECTOR; MALE; THROUGH HOLE; BREAKAWAY; STRAIGHT; 2PINS; -65 DEGC TO +125 DEGC;
J5	1	PPPC092LJBN-RC	SULLINS ELECTRONICS CORP	PPPC0 92LJB N-RC	CONNECTOR; FEMALE; THROUGH HOLE; PPP SERIES; RIGHT ANGLE; 18PINS
MH1-MH4	4	9032	KEYSTONE	9032	MACHINE FABRICATED; ROUND-THRU HOLE SPACER; NO THREAD; M3.5; 5/8IN; NYLON
PCB	1	MAX77857	MAXIM	PCB	PCB:MAX77857
PGND1S, PGND2S	2	5001	KEYSTONE	N/A	TEST POINT; PIN DIA=0.1IN; TOTAL LENGTH=0.3IN; BOARD HOLE=0.04IN; BLACK; PHOSPHOR BRONZE WIRE SILVER PLATE FINISH;
R1	1	CRCW0402510KFK	VISHAY DALE	510K	RES; SMT (0402); 510K; 1%; +/- 100PPM/DEGC; 0.0630W
R13	1	ERJ-2RKF1502	PANASONIC	15K	RES; SMT (0402); 15K; 1%; +/- 100PPM/DEGC; 0.1000W
R4, R7	2	CRCW04022K20FK; RC0402FR-072K2L	VISHAY DALE;YAGEO PHICOMP	2.2K	RES; SMT (0402); 2.2K; 1%; +/- 100PPM/DEGC; 0.0630W
SU1, SU2	2	S1100-B; SX1100-B; STC02SYAN	KYCON;KYCON;SULLINS ELECTRONICS CORP.	SX110 0-B	TEST POINT; JUMPER; STR; TOTAL LENGTH=0.24IN; BLACK; INSULATION=PBT;PHOSPHOR BRONZE CONTACT=GOLD PLATED
C3, C12	DNP	N/A	N/A	OPEN	CAPACITOR; SMT (0805); OPEN; FORMFACTOR
LX1, LX2, OUT1	DNP	SS-102-TT-2	SAMTEC	SS-102-TT-2	IC-SOCKET; SIP; STRAIGHT; PRECISION MACHINED SOCKET STRIP; OPEN FRAME; 2PINS; 100MIL
R2, R6	DNP	N/A	N/A	OPEN	RESISTOR; 0402; OPEN; FORMFACTOR
R8	DNP	3296Y-1-204LF	BOURNS	200K	RESISTOR; THROUGH HOLE-RADIAL LEAD; 3296 SERIES; 200K OHM; 10%; 100PPM; 0.5W
	48				

MAX77857 EV Kit Schematic

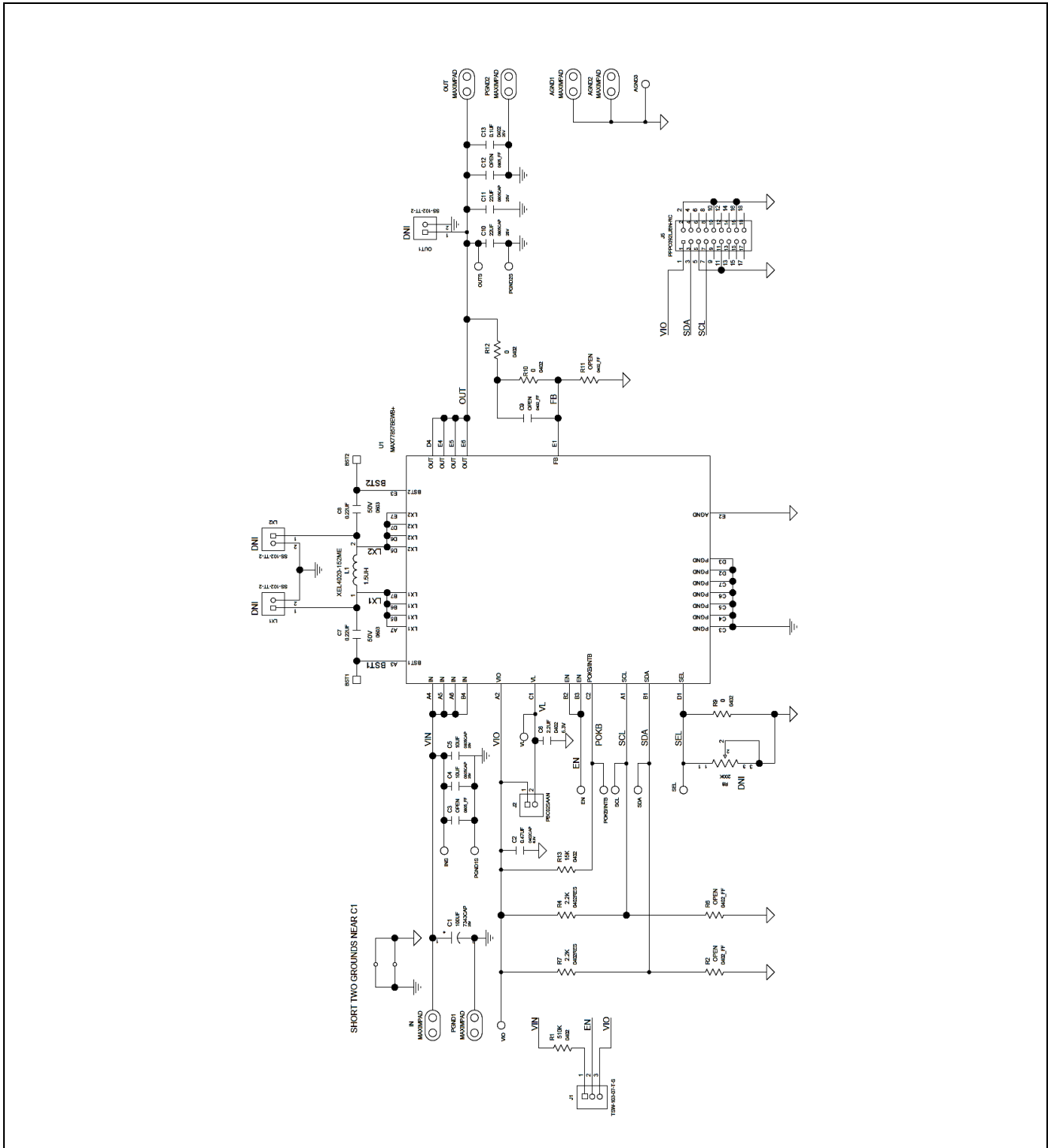

MAX77857 EV Kit PCB Layouts

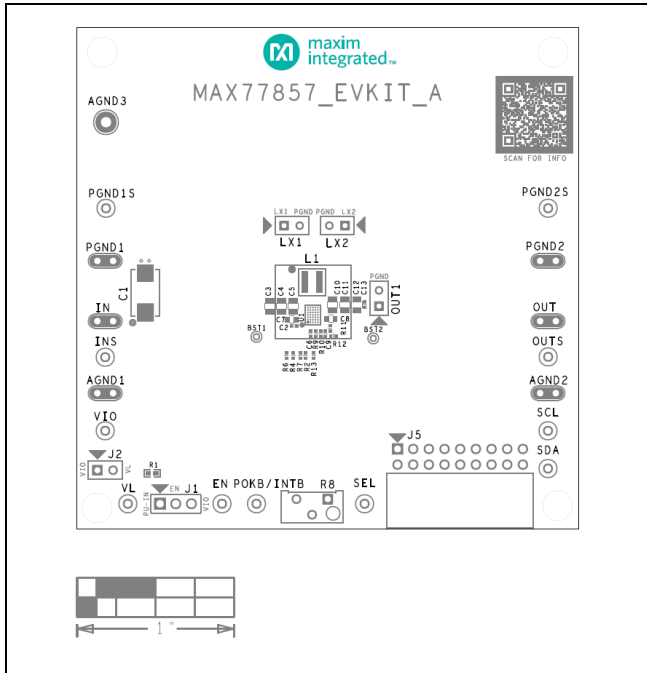

MAX77857 EV Kit Component Placement Guide—Top Silkscreen

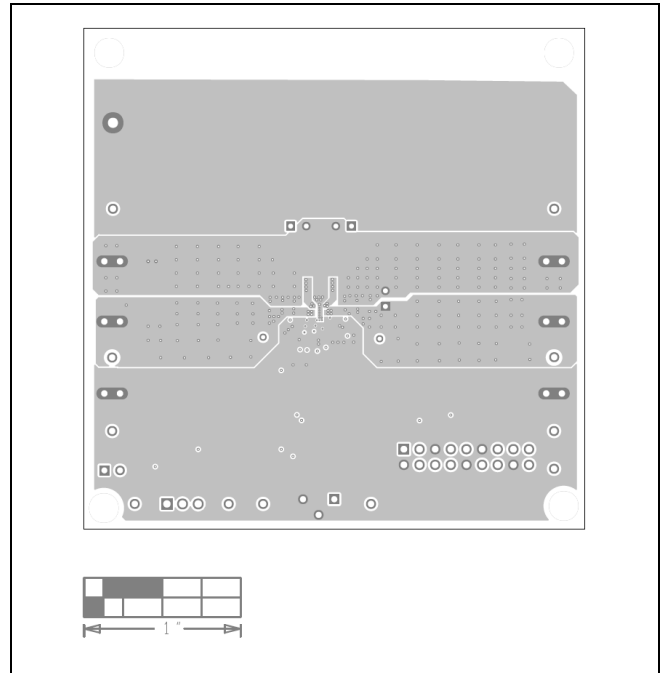

MAX77857 EV Kit PCB Layout—Internal 2

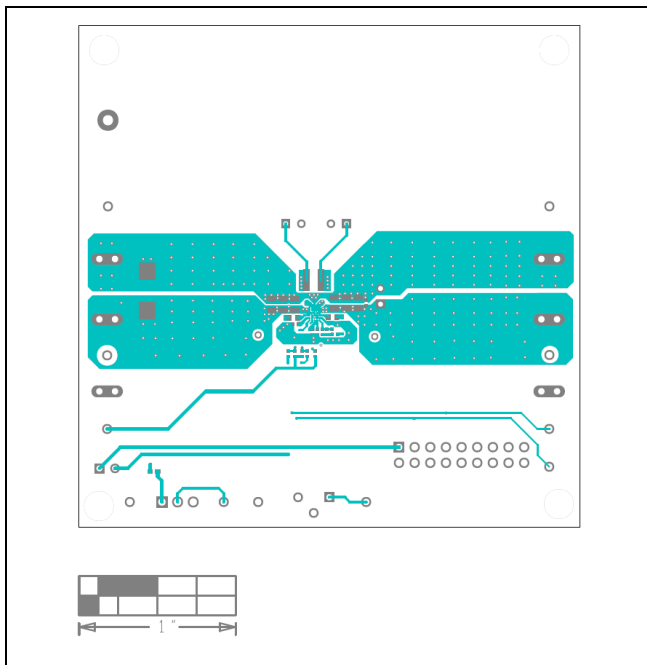

MAX77857 EV Kit PCB Layout—Top View

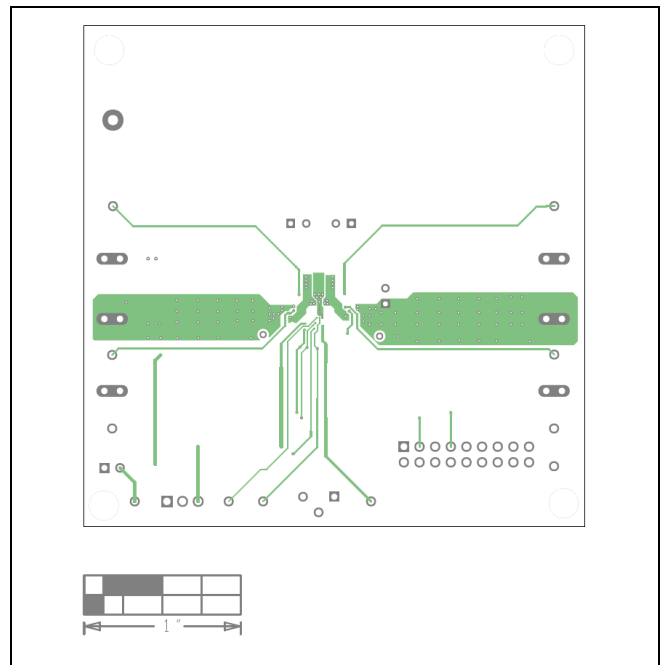

MAX77857 EV Kit PCB Layout—Internal 3

MAX77857 EV Kit PCB Layouts (continued)

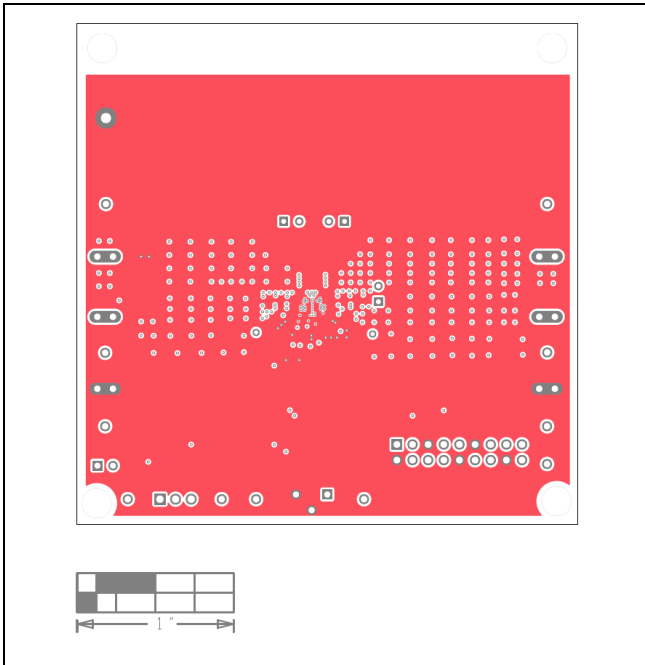

MAX77857 EV Kit PCB Layout—Internal 4

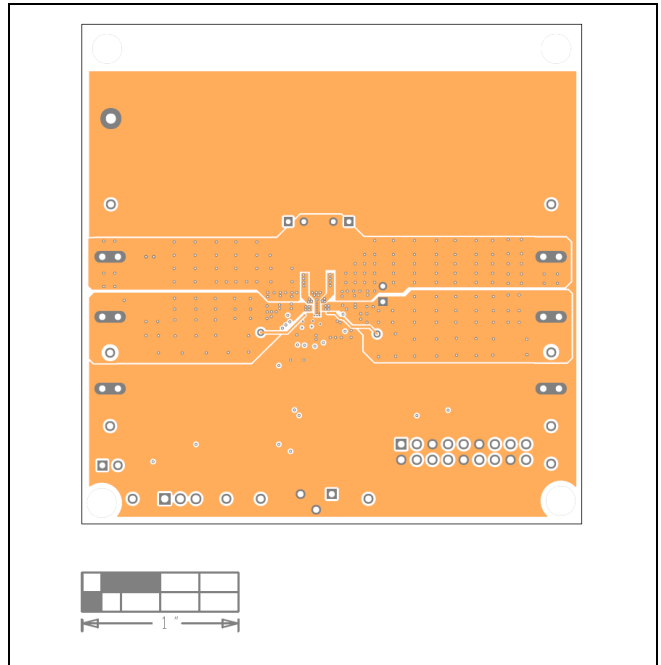

MAX77857 EV Kit PCB Layout—Internal 5

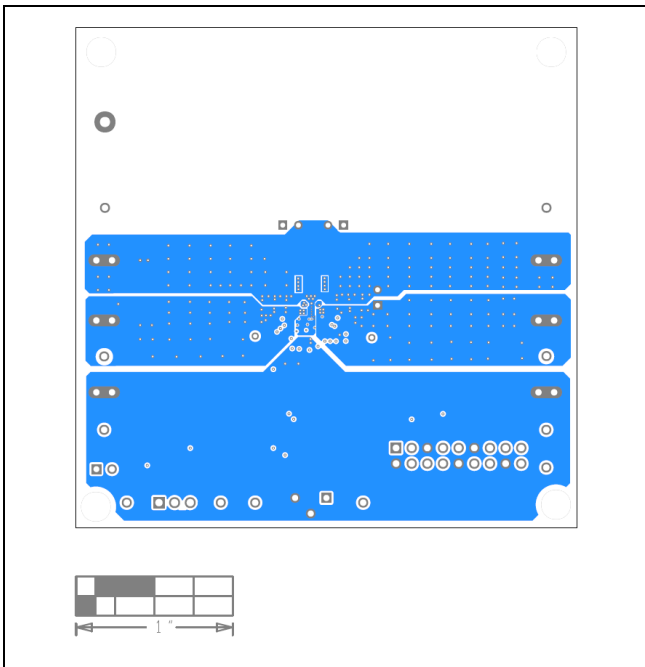

MAX77857 EV Kit PCB Layout—Bottom View

Revision History

REVISION NUMBER	REVISION DATE	DESCRIPTION	PAGES CHANGED
0	3/22	Initial release	—

