

RSM822N

subminiature signal relays



- Subminiature monostable relays for switching low loads
- DC coils - standard and sensitive of up to 48 V DC, low coil power 0,20 W (sensitive version) or 0,30 W (standard version) • For PCB
- Sealed, for wave soldering and cleaning • Double bifurcated contact
- Application: for telecommunication devices, office equipment, alarm systems, measuring instruments, medical monitoring devices, AV devices, control sensors
- Conforms to FCC Part 68 - 1500 V - lightning surge
- Recognitions, certifications, directives: RoHS, 

Contact data

Number and type of contacts		2 CO
Contact material		AgNi/Au 0,2 μm
Rated / max. switching voltage	AC	125 V / 250 V
Min. switching voltage		10 mV 1
Rated load	AC1	0,6 A / 125 V AC
	DC1	3 A / 2 A (NO/NC) / 30 V DC
Min. switching current		1 mA 1
Rated current		0,6 A / 125 V AC 2 A / 30 V DC
Max. breaking capacity	AC1	125 VA
Contact resistance		≤ 100 mΩ

Coil data

Rated voltage	DC	3 ... 24 V sensitive version	48 V standard version
Must release voltage		DC: ≥ 0,1 U _n	
Operating range of supply voltage		see Tables 1, 2	
Rated power consumption	DC	0,20 W sensitive version	0,30 W standard version

Insulation according to PN-EN 60664-1

Insulation resistance		> 1 000 MΩ	500 V DC, 60 s
Dielectric strength			
• between coil and contacts		1 000 V AC	type of insulation: basic (1500 V AC; 1,2 / 50 μs)
• contact clearance		1 000 V AC	type of clearance: micro-disconnection (1500 V AC; 1,2 / 50 μs)
• pole - pole		1 000 V AC	type of insulation: basic (1500 V AC; 1,2 / 50 μs)
Contact - coil distance			
• clearance		≥ 1,3 mm	
• creepage		≥ 1,5 mm	

General data

Operating / release time (typical values)		4,5 ms / 1,5 ms	
Electrical life (number of cycles)			
• resistive AC1	1 800 cycles/hour	10 ⁵	0,6 A, 125 V AC
• resistive DC1	1 800 cycles/hour	10 ⁵	2 A, 30 V DC
Mechanical life	18 000 cycles/hour	10 ⁸	
Dimensions (L x W x H)		20,5 x 10,2 x 12,5 mm	
Weight		4,5 g	
Ambient temperature	• operating	-30...+90 °C sensitive version	-30...+80 °C standard version
Cover protection category		IP 64	PN-EN 60529
Shock resistance		10 g	
Vibration resistance		1,5 mm DA (constant amplitude)	10...55 Hz
Solder bath temperature		max. 235 °C	
Soldering time		max. 3,5 s	

The data in bold type pertain to the standard versions of the relays.

1 Reference value, relays previously tested and used at the resistance load of more than 10 mA / 6 V DC or at the peak AC voltage are not recommended for later switching of low level signals.

RSM822N

subminiature signal relays

Coil data - DC voltage version, sensitive

Table 1

Coil code	Rated voltage V DC	Coil resistance at 20 °C Ω	Acceptable resistance	Coil operating range V DC	
				min. (at 20 °C)	max. (at 20 °C)
S003	3	45	± 10%	2,1	6,5
S005	5	125	± 10%	3,5	10,8
S006	6	180	± 10%	4,2	13,0
S009	9	405	± 10%	6,3	19,5
S012	12	720	± 10%	8,4	26,5
S024	24	2 880	± 10%	16,8	52,9

Coil data - DC voltage version, standard

Table 2

Coil code	Rated voltage V DC	Coil resistance at 20 °C Ω	Acceptable resistance	Coil operating range V DC	
				min. (at 20 °C)	max. (at 20 °C)
1048	48	7 680	± 10%	33,6	84,9

Dimensions

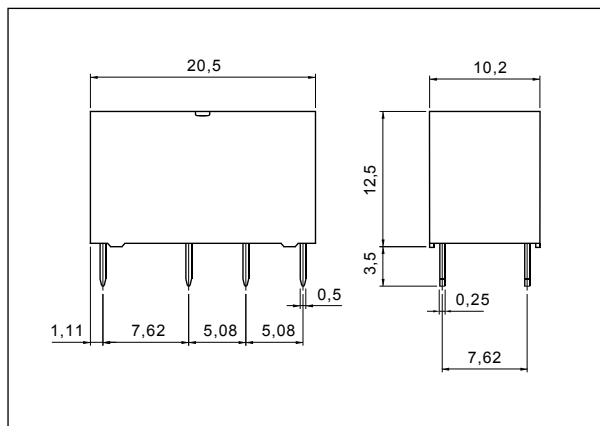

Connection diagram (pin side view)

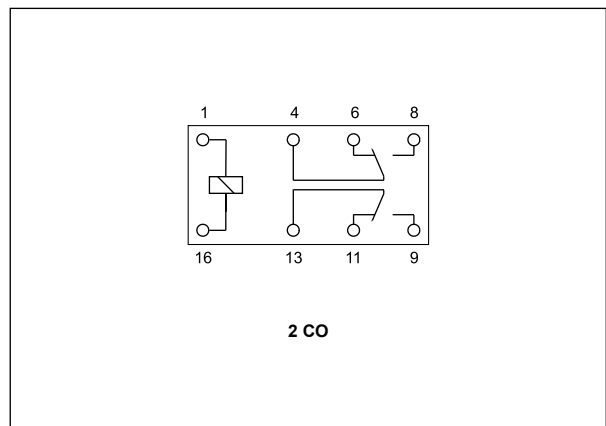

Electrical life at AC resistive current.
Switching frequency: 1 800 cycles/hour

Fig. 1

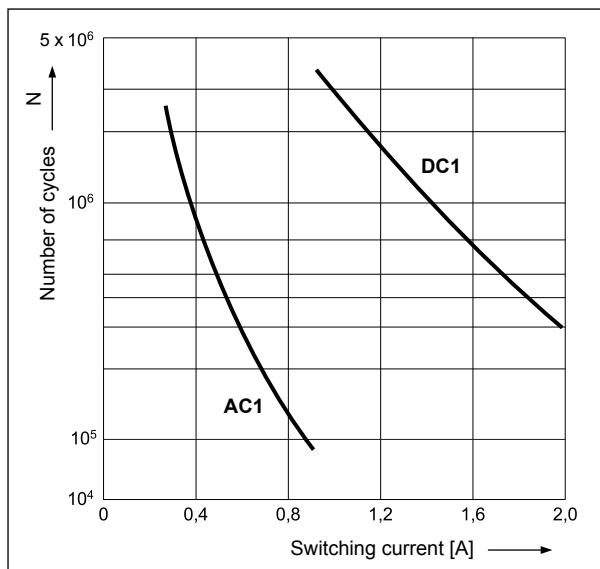

Max. DC resistive load breaking capacity

Fig. 2

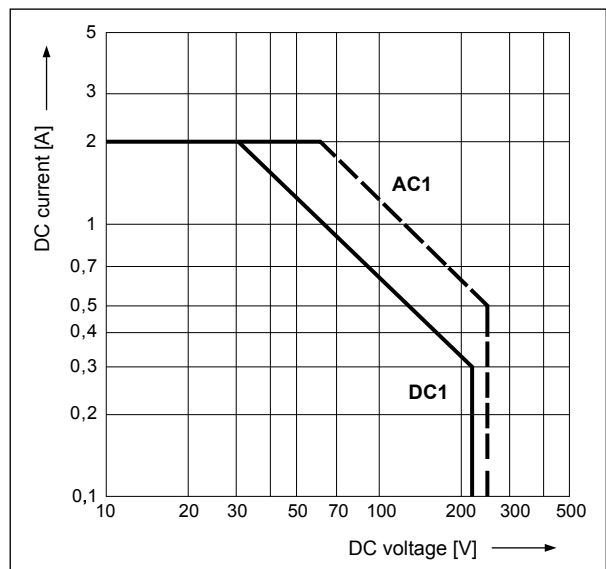

02.12.2013

RSM822N

subminiature signal relays

Pinout (solder side view)

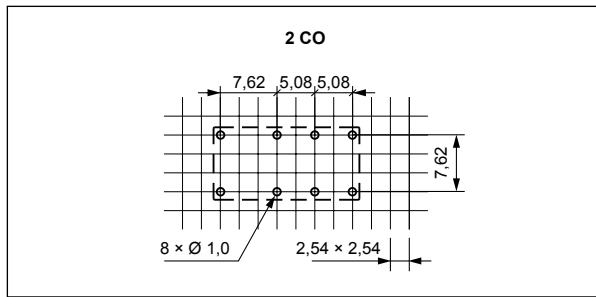

Mounting

Relays **RSM822N** are designed for direct PCB mounting.

Ordering codes

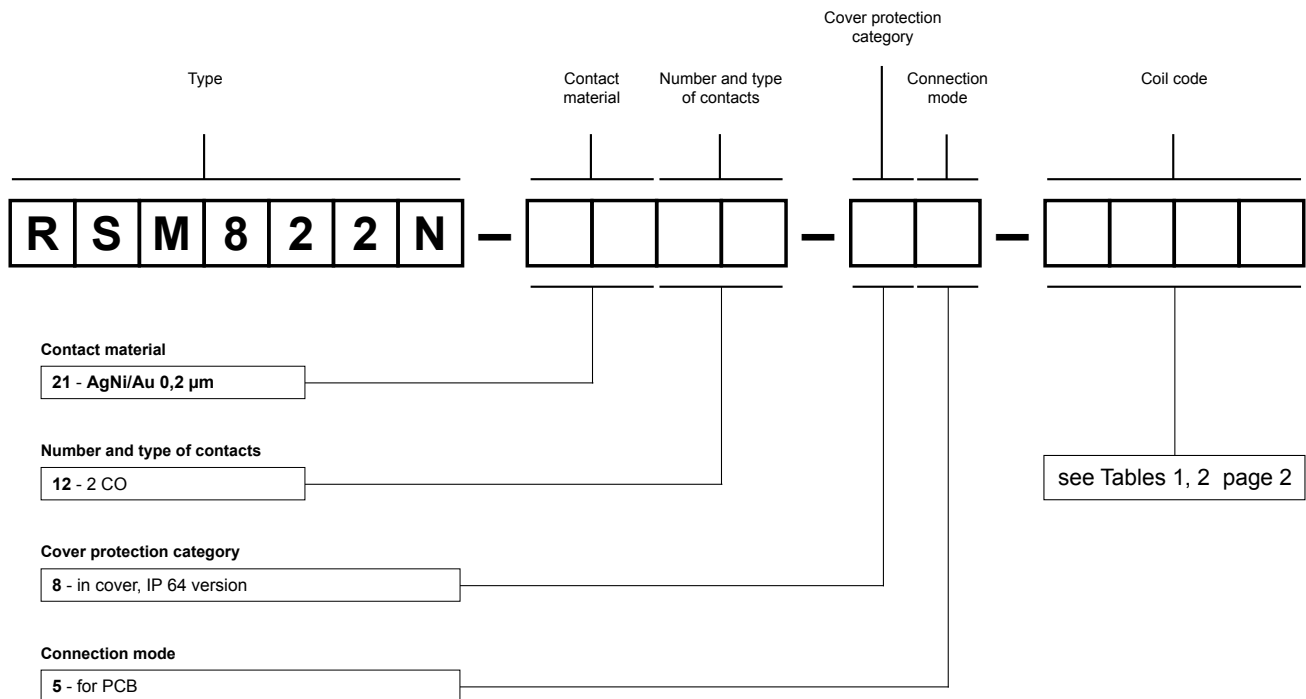

Examples of ordering codes:

RSM822N-2112-85-S005 relay **RSM822N**, for PCB, two changeover contacts, contact material AgNi/Au 0,2 µm, sensitive coil voltage 5 V DC, in cover IP 64

RSM822N-2112-85-1048 relay **RSM822N**, for PCB, two changeover contacts, contact material AgNiAu 0,2 µm, standard coil voltage 48 V DC, in cover IP 64

PRECAUTIONS:

1. Ensure that the parameters of the product described in its specification provide a safety margin for the appropriate operation of the device or system and never use the product in circumstances which exceed the parameters of the product. 2. Never touch any live parts of the device. 3. Ensure that the product has been connected correctly. An incorrect connection may cause malfunction, excessive heating or risk of fire. 4. In case of any risk of any serious material loss or death or injuries of humans or animals, the devices or systems shall be designed so to equip them with double safety system to guarantee their reliable operation.