

MKN POWER SUPPLY 1-PHASE, LINEAR REGULATED

IN: 230VAC OUT: 10V/0,08ADC

INPUT: 230 V AC
OUTPUT: 10 V DC
Current: 80 mA

This power supply units meet the (EN 61000-3-2) standard for harmonic current.

[Link to Product](#)

Illustration

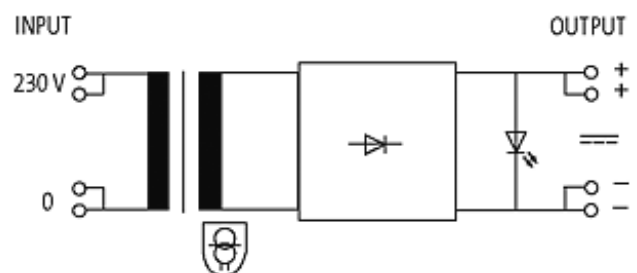

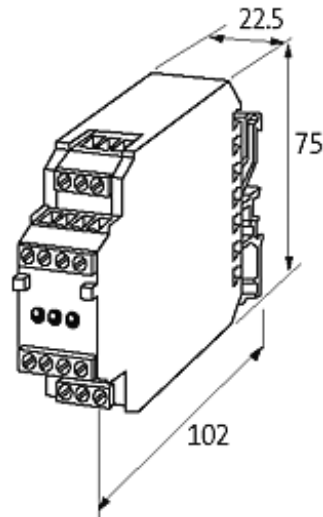

Product may differ from Image

Approvals



Input

Input voltage	207...253 V AC
Input current	approx. 20 mA
Input fuse (external)	63 mA (T)
Frequency	50...60 Hz

General data

Standards	(EN 61558-2-6), (EN 62041 category II), (EN 55011 B), (EN 61000-3-2)
Mounting method	DIN-rail mountable TH35 or G32 (EN 60715)
Temperature range	0...+60 °C, no condensation

Output

Output current	max. 80 mA
Ripple	max. 10 mV p-p
Output filter	VDR and smoothing capacitor
Unit protection	short-circuit and overload protected
LED display	LED (green): in operation

Commercial data

country of origin	CZ
customs tariff number	85044090
minimum order quantity	1