

REV. CON. ASS., AC3:55KW/400V, 20-33 V AC/DC, 3-POLE, SIZE S3 SCREW TERMINALS ELEC. AND MECH. INTERLO. 2NO AND INTEGRATED VARISTOR



Figure similar

Product brand name	SIRIUS
Product designation	Reversing contactor assembly
Product type designation	3RA23
Manufacturer's article number	<ul style="list-style-type: none"> • 1 of the supplied contactor 3RT2047-1NB30-0CC0 • 2 of the supplied contactor 3RT2047-1NB30 • of the supplied RS assembly kit 3RA2943-2AA1

General technical data	
Size of contactor	S3
Product extension	Yes
<ul style="list-style-type: none"> • Auxiliary switch 	
Insulation voltage	690 V
<ul style="list-style-type: none"> • with degree of pollution 3 rated value 	
Degree of pollution	3
Surge voltage resistance rated value	6 kV
Protection class IP	IP20
<ul style="list-style-type: none"> • on the front 	

Shock resistance at rectangular impulse	
• at AC	6.7 g / 5 ms, 4.0 g / 10 ms
• at DC	6.7 g / 5 ms, 4.0 g / 10 ms
Shock resistance with sine pulse	
• at AC	10.6 g / 5 ms, 6.3 g / 10 ms
• at DC	10.6 g / 5 ms, 6.3 g / 10 ms
Mechanical service life (switching cycles)	
• of contactor typical	10 000 000
• of the contactor with added auxiliary switch block typical	10 000 000
Equipment marking	
• acc. to DIN EN 81346-2	Q

Ambient conditions

Installation altitude at height above sea level	
• maximum	2 000 m
Ambient temperature	
• during operation	-25 ... +60 °C
• during storage	-55 ... +80 °C

Main circuit

Number of poles for main current circuit	3
Number of NO contacts for main contacts	0
Number of NC contacts for main contacts	0
Operating voltage	
• at AC-3 rated value maximum	1 000 V
Operating current	
• at AC-1 at 400 V	
— at ambient temperature 40 °C rated value	130 A
— at ambient temperature 60 °C rated value	110 A
Operating frequency	
• at AC-1 maximum	900 1/h
• at AC-2 maximum	350 1/h
• at AC-3 maximum	850 1/h
• at AC-4 maximum	200 1/h

Control circuit/ Control

Type of voltage of the control supply voltage	AC/DC
Control supply voltage 1 at AC	
• at 50 Hz	20 ... 33 V
• at 60 Hz	20 ... 33 V
Control supply voltage 1	
• at DC	20 ... 33 V

Operating range factor control supply voltage rated value of magnet coil at AC	
• at 50 Hz	0.8 ... 1.1
• at 60 Hz	0.8 ... 1.1
Apparent pick-up power of magnet coil at AC	
• at 50 Hz	163 V·A
• at 60 Hz	163 V·A
Apparent holding power of magnet coil at AC	
• at 50 Hz	3.1 V·A
• at 60 Hz	3.1 V·A
Closing power of magnet coil at DC	76 W
Holding power of magnet coil at DC	1.8 W

Auxiliary circuit

Number of NC contacts	
• for auxiliary contacts	
— per direction of rotation	0
— instantaneous contact	0
Number of NO contacts	
• for auxiliary contacts	
— per direction of rotation	1
— instantaneous contact	0
Operating current of auxiliary contacts at AC-12 maximum	10 A
Operating current of auxiliary contacts at AC-15	
• at 230 V	6 A
• at 400 V	3 A
Operating current of auxiliary contacts at DC-13	
• at 24 V	10 A
• at 60 V	2 A
• at 110 V	1 A
• at 220 V	0.3 A

UL/CSA ratings

Full-load current (FLA) for three-phase AC motor	
• at 480 V rated value	96 A
• at 600 V rated value	99 A
Yielded mechanical performance [hp]	
• for single-phase AC motor	
— at 110/120 V rated value	10 hp
— at 230 V rated value	20 hp
• for three-phase AC motor	
— at 200/208 V rated value	30 hp

— at 220/230 V rated value	40 hp
— at 460/480 V rated value	75 hp
— at 575/600 V rated value	100 hp
Contact rating of auxiliary contacts according to UL	A600 / Q600

Short-circuit protection

Design of the fuse link <ul style="list-style-type: none"> • for short-circuit protection of the main circuit <ul style="list-style-type: none"> — with type of coordination 1 required • for short-circuit protection of the auxiliary switch required 	gG NH 3NA, DIAZED 5SB, NEOZED 5SE: 355 A fuse gG: 10 A
--	---

Installation/ mounting/ dimensions

Mounting position	+/-180° rotation possible on vertical mounting surface; can be tilted forward and backward by +/- 22.5° on vertical mounting surface
Mounting type	screw and snap-on mounting onto 35 mm standard mounting rail
Height	160 mm
Width	150 mm
Depth	152 mm
Required spacing <ul style="list-style-type: none"> • with side-by-side mounting <ul style="list-style-type: none"> — forwards — Backwards — upwards — downwards — at the side • for grounded parts <ul style="list-style-type: none"> — forwards — Backwards — upwards — at the side — downwards • for live parts <ul style="list-style-type: none"> — forwards — Backwards — upwards — downwards — at the side 	10 mm 0 mm 10 mm 10 mm 10 mm 10 mm 10 mm 0 mm 10 mm 10 mm 10 mm 10 mm 0 mm 10 mm 10 mm 10 mm

Connections/Terminals

Type of electrical connection <ul style="list-style-type: none"> • for main current circuit • for auxiliary and control current circuit 	screw-type terminals screw-type terminals
--	--

Type of connectable conductor cross-sections <ul style="list-style-type: none"> • for main contacts <ul style="list-style-type: none"> — single or multi-stranded — finely stranded with core end processing — finely stranded without core end processing • at AWG conductors for main contacts 	2x (2.5 ... 16 mm ²), 2x (10 ... 50 mm ²), 1x (10 ... 70 mm ²) 2x (2.5 ... 35 mm ²), 1x (2.5 ... 50 mm ²) 2x (10 ... 35 mm ²), 1x (10 ... 50 mm ²) 2x (10 ... 1/0), 1x (10 ... 2/0)
Type of connectable conductor cross-sections <ul style="list-style-type: none"> • for auxiliary contacts <ul style="list-style-type: none"> — single or multi-stranded — finely stranded with core end processing • at AWG conductors for auxiliary contacts 	2x (0,5 ... 1,5 mm ²), 2x (0,75 ... 2,5 mm ²) 2x (0.5 ... 1.5 mm ²), 2x (0.75 ... 2.5 mm ²) 2x (20 ... 16), 2x (18 ... 14)









Safety related data

Proportion of dangerous failures <ul style="list-style-type: none"> • with low demand rate acc. to SN 31920 • with high demand rate acc. to SN 31920 	40 % 73 %
T1 value for proof test interval or service life acc. to IEC 61508	20 y

Communication/ Protocol

Product function Bus communication	Yes
Protocol is supported <ul style="list-style-type: none"> • AS-interface protocol 	Yes
Product function Control circuit interface with IO link	Yes

Certificates/approvals

General Product Approval	Declaration of Conformity	Test Certificates	Marine / Shipping
 UL	 EAC	 EG-Konf.	Type Test Certificates/Test Report  BUREAU VERITAS
			 GL
Marine / Shipping	other		
 LRS	 RMRS	 DNV-GL DNVGL.COM/AF	Confirmation

Further information

Information- and Downloadcenter (Catalogs, Brochures,...)
<http://www.siemens.com/industrial-controls/catalogs>

Industry Mall (Online ordering system)
<https://mall.industry.siemens.com/mall/en/en/Catalog/product?mlfb=3RA2347-8XE30-1NB3>

Cax online generator

<http://support.automation.siemens.com/WW/CAXorder/default.aspx?lang=en&mlfb=3RA2347-8XE30-1NB3>

Service&Support (Manuals, Certificates, Characteristics, FAQs,...)

<https://support.industry.siemens.com/cs/ww/en/ps/3RA2347-8XE30-1NB3>

Image database (product images, 2D dimension drawings, 3D models, device circuit diagrams, EPLAN macros, ...)

http://www.automation.siemens.com/bilddb/cax_de.aspx?mlfb=3RA2347-8XE30-1NB3&lang=en

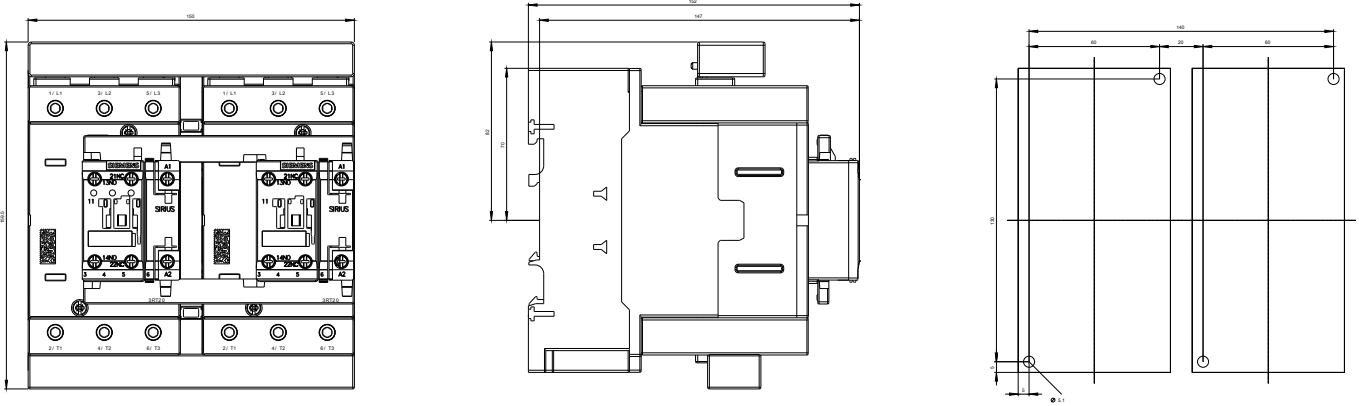

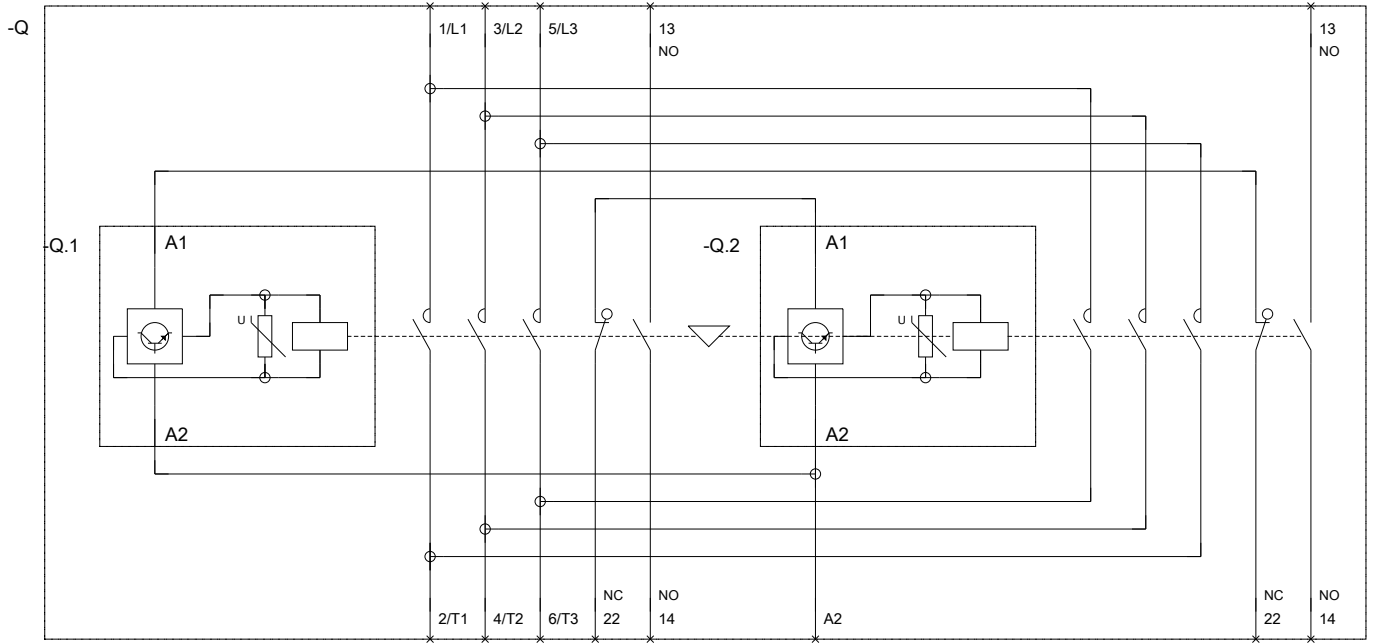

last modified:

10/13/2017