

# GBU6A - GBU6M Bridge Rectifiers

## Features

- Glass-Passivated Junction
- Surge Overload Rating: 175 A Peak
- Reliable Low-Cost Construction Utilizing Molded Plastic Technique
- Ideal for Printed Circuit Board
- UL Certified: UL #E258596

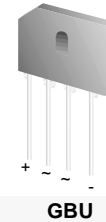

## Ordering Informations

| Part Number | Marking | Package | Packing Method |
|-------------|---------|---------|----------------|
| GBU6A       | GBU6A   | GBU 4L  | Rail           |
| GBU6B       | GBU6B   | GBU 4L  | Rail           |
| GBU6D       | GBU6D   | GBU 4L  | Rail           |
| GBU6G       | GBU6G   | GBU 4L  | Rail           |
| GBU6J       | GBU6J   | GBU 4L  | Rail           |
| GBU6K       | GBU6K   | GBU 4L  | Rail           |
| GBU6M       | GBU6M   | GBU 4L  | Rail           |

## Absolute Maximum Ratings<sup>(1)</sup>

Stresses exceeding the absolute maximum ratings may damage the device. The device may not function or be operable above the recommended operating conditions and stressing the parts to these levels is not recommended. In addition, extended exposure to stresses above the recommended operating conditions may affect device reliability. The absolute maximum ratings are stress ratings only. Values are at  $T_A = 25^\circ\text{C}$  unless otherwise noted.

| Symbol      | Parameter   | Value       |     |     |     |     |     |      | Units            |
|-------------|---|-------------|-----|-----|-----|-----|-----|------|------------------|
|             |   | 6A          | 6B  | 6D  | 6G  | 6J  | 6K  | 6M   |                  |
| $V_{RRM}$   | Maximum Repetitive Reverse Voltage  | 50          | 100 | 200 | 400 | 600 | 800 | 1000 | V                |
| $V_{RMS}$   | Maximum RMS Bridge Input Voltage  | 35          | 70  | 140 | 280 | 420 | 560 | 700  | V                |
| $V_R$       | DC Reverse Voltage (Rated $V_R$ )   | 50          | 100 | 200 | 400 | 600 | 800 | 1000 | V                |
| $I_{F(AV)}$ | Average Rectified Forward Current $T_A = 100^\circ\text{C}$               | 6.0         |     |     |     |     |     |      | A                |
| $I_{FSM}$   | Non-Repetitive Peak Forward Surge Current<br>8.3 ms Single Half-Sine-Wave | 175         |     |     |     |     |     |      | A                |
| $T_{STG}$   | Storage Temperature Range   | -55 to +150 |     |     |     |     |     |      | $^\circ\text{C}$ |
| $T_J$       | Operating Junction Temperature  | -55 to +150 |     |     |     |     |     |      | $^\circ\text{C}$ |

### Note:

1. These ratings are limiting values above which the serviceability of any semiconductor device may be impaired.

## Thermal Characteristics

Values are at  $T_A = 25^\circ\text{C}$  unless otherwise noted.

| Symbol          | Parameter  | Value | Units              |
|-----------------|--|-------|--------------------|
| $P_D$           | Power Dissipation  | 12    | W                  |
| $R_{\theta JA}$ | Thermal Resistance per Leg, Junction to Ambient <sup>(2)</sup> | 18.6  | $^\circ\text{C/W}$ |
| $R_{\theta JL}$ | Thermal Resistance per Leg, Junction to Lead <sup>(3)</sup>    | 3.1   | $^\circ\text{C/W}$ |

### Notes:

- Device mounted on PCB with 0.5 x 0.5 inch (12 x 12 mm).
- Device mounted on Al plate with 2.6 x 1.4 x 0.06 inch (6.5 x 3.5 x 0.15 cm).

## Electrical Characteristics

Values are at  $T_A = 25^\circ\text{C}$  unless otherwise noted.

| Symbol | Parameter                                   | Value                     | Units |                      |
|--------|---|---------------------------|-------|----------------------|
| $V_F$  | Forward Voltage, per Element                | 6.0 A<br>1.0              | V     |                      |
| $I_R$  | Reverse Current, per Element at Rated $V_R$ | $T_A = 25^\circ\text{C}$  | 5.0   | $\mu\text{A}$        |
|        |   | $T_A = 125^\circ\text{C}$ | 500   | $\mu\text{A}$        |
| $I^2t$ | $I^2t$ Rating for Fusing                    | $t < 8.35 \text{ ms}$     | 127   | $\text{A}^2\text{s}$ |

## Typical Performance Characteristics

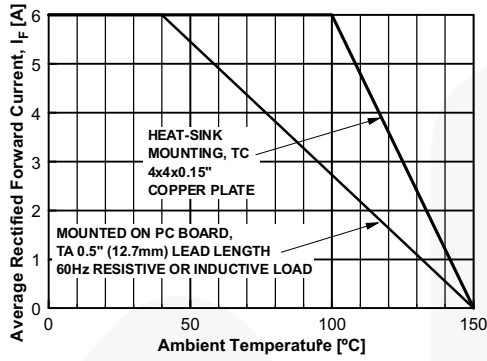

Figure 1. Forward Current Derating Curve

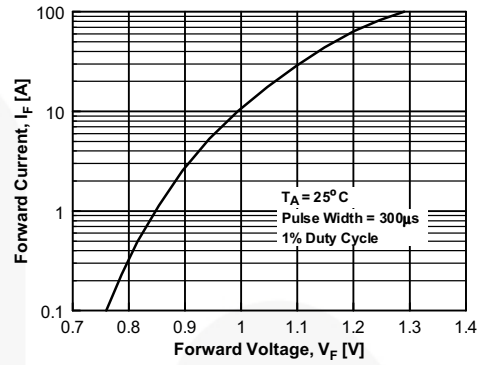

Figure 2. Forward Voltage Characteristics

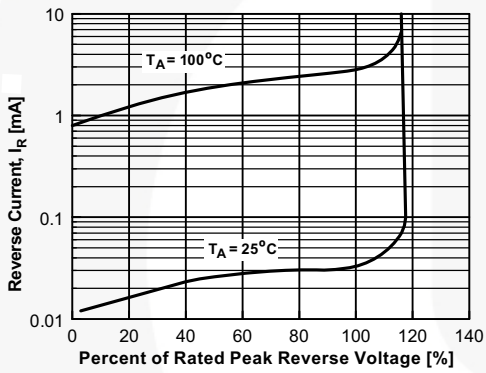

Figure 3. Reverse Current vs. Reverse Voltage

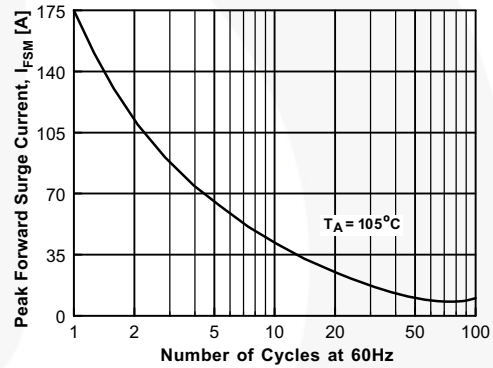

Figure 4. Non-Repetitive Surge Current

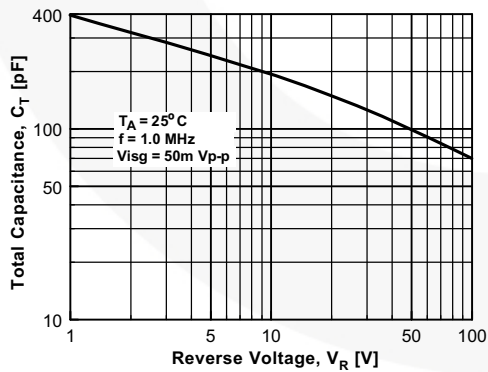
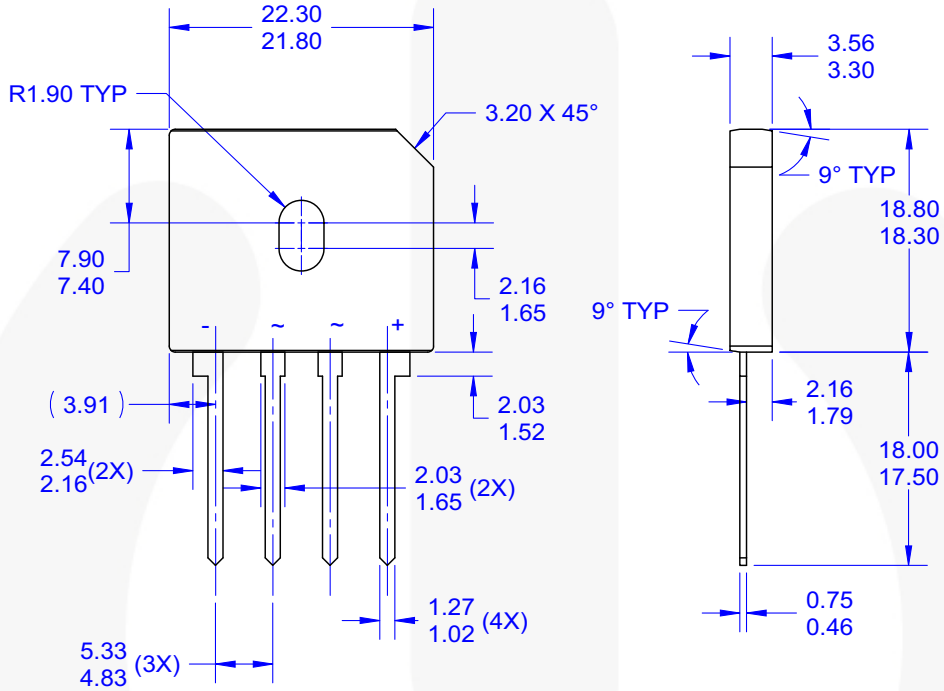

Figure 5. Total Capacitance

**Physical Dimension**

**GBU-4L**



**NOTES:**

- A. THIS PACKAGE DOES NOT CONFORM TO ANY STANDARDS.
- B. ALL DIMENSIONS ARE IN MILLIMETERS.
- C. DIMENSIONS ARE EXCLUSIVE OF BURRS, MOLD FLASH AND TIE BAR PROTRUSIONS.
- E. DIMENSION AND TOLERANCE AS PER ASME Y14.5-1994.
- F. DRAWING FILE NAME: GBU04AREV1

**Figure 6. 4-LEAD, GBU, THROUGH-HOLE, MOLDED PACKAGE (ACTIVE)**





Package drawings are provided as a service to customers considering Fairchild components. Drawings may change in any manner without notice. Please note the revision and/or date on the drawing and contact a Fairchild Semiconductor representative to verify or obtain the most recent revision. Package specifications do not expand the terms of Fairchild's worldwide terms and conditions, specifically the warranty therein, which covers Fairchild products.

Always visit Fairchild Semiconductor's online packaging area for the most recent package drawings:  
<http://www.fairchildsemi.com/dwg/GB/GBU04A.pdf>



**TRADEMARKS**

The following includes registered and unregistered trademarks and service marks, owned by Fairchild Semiconductor and/or its global subsidiaries, and is not intended to be an exhaustive list of all such trademarks.

- |   |  |   |   |
|---|--|---|---|
| AccuPower™  | F-PFS™   |  | Sync-Lock™  |
| AX-CAP®*  | FRFET®   | PowerTrench®  |  |
| BitSiC™   | Global Power Resource™                         | PowerXS™  | TinyBoost®  |
| Build it Now™   | GreenBridge™                                   | Programmable Active Droop™  | TinyBuck®   |
| CorePLUS™   | Green FPS™                                     | QFET®   | TinyCalc™   |
| CorePOWER™  | Green FPS™ e-Series™                           | QS™   | TinyLogic®  |
| CROSSVOLT™  | Gmax™  | Quiet Series™   | TINYOPTO™   |
| CTL™  | GTO™   | RapidConfigure™   | TinyPower™  |
| Current Transfer Logic™   | IntelliMAX™                                    |  | TinyPWM™  |
| DEUXPEED®   | ISOPLANAR™                                     | Saving our world, 1mW/W/kW at a time™   | TinyWire™   |
| Dual Cool™  | Making Small Speakers Sound Louder and Better™ | SignalWise™   | TranSiC™  |
| EcoSPARK®   | MegaBuck™                                      | SmartMax™   | TriFault Detect™  |
| EfficientMax™   | MICROCOUPLER™                                  | SMART START™  | TRUECURRENT®*   |
| ESBC™   | MicroFET™                                      | Solutions for Your Success™   | µSerDes™  |
|  | MicroPak™                                      | SPM®  |  |
| Fairchild®  | MicroPak2™                                     | STEALTH™  | UHC®  |
| Fairchild Semiconductor®  | MillerDrive™                                   | SuperFET®   | Ultra FRFET™  |
| FACT Quiet Series™  | MotionMax™                                     | SuperSOT™-3   | UniFET™   |
| FACT®   | mWSaver®                                       | SuperSOT™-6   | VXC™  |
| FAST®   | OptoHiT™                                       | SuperSOT™-8   | VisualMax™  |
| FastvCore™  | OPTOLOGIC®                                     | SupreMOS®   | VoltagePlus™  |
| FETBench™   | OPTOPLANAR®                                    | SyncFET™  | XS™   |
| FPS™  |  |   |   |

\* Trademarks of System General Corporation, used under license by Fairchild Semiconductor.

**DISCLAIMER**

FAIRCHILD SEMICONDUCTOR RESERVES THE RIGHT TO MAKE CHANGES WITHOUT FURTHER NOTICE TO ANY PRODUCTS HEREIN TO IMPROVE RELIABILITY, FUNCTION, OR DESIGN. FAIRCHILD DOES NOT ASSUME ANY LIABILITY ARISING OUT OF THE APPLICATION OR USE OF ANY PRODUCT OR CIRCUIT DESCRIBED HEREIN; NEITHER DOES IT CONVEY ANY LICENSE UNDER ITS PATENT RIGHTS, NOR THE RIGHTS OF OTHERS. THESE SPECIFICATIONS DO NOT EXPAND THE TERMS OF FAIRCHILD'S WORLDWIDE TERMS AND CONDITIONS, SPECIFICALLY THE WARRANTY THEREIN, WHICH COVERS THESE PRODUCTS.

**LIFE SUPPORT POLICY**

FAIRCHILD'S PRODUCTS ARE NOT AUTHORIZED FOR USE AS CRITICAL COMPONENTS IN LIFE SUPPORT DEVICES OR SYSTEMS WITHOUT THE EXPRESS WRITTEN APPROVAL OF FAIRCHILD SEMICONDUCTOR CORPORATION.

As used herein:

1. Life support devices or systems are devices or systems which, (a) are intended for surgical implant into the body or (b) support or sustain life, and (c) whose failure to perform when properly used in accordance with instructions for use provided in the labeling, can be reasonably expected to result in a significant injury of the user.
2. A critical component in any component of a life support, device, or system whose failure to perform can be reasonably expected to cause the failure of the life support device or system, or to affect its safety or effectiveness.

**ANTI-COUNTERFEITING POLICY**

Fairchild Semiconductor Corporation's Anti-Counterfeiting Policy. Fairchild's Anti-Counterfeiting Policy is also stated on our external website, [www.fairchildsemi.com](http://www.fairchildsemi.com), under Sales Support.

Counterfeiting of semiconductor parts is a growing problem in the industry. All manufacturers of semiconductor products are experiencing counterfeiting of their parts. Customers who inadvertently purchase counterfeit parts experience many problems such as loss of brand reputation, substandard performance, failed applications, and increased cost of production and manufacturing delays. Fairchild is taking strong measures to protect ourselves and our customers from the proliferation of counterfeit parts. Fairchild strongly encourages customers to purchase Fairchild parts either directly from Fairchild or from Authorized Fairchild Distributors who are listed by country on our web page cited above. Products customers buy either from Fairchild directly or from Authorized Fairchild Distributors are genuine parts, have full traceability, meet Fairchild's quality standards for handling and storage and provide access to Fairchild's full range of up-to-date technical and product information. Fairchild and our Authorized Distributors will stand behind all warranties and will appropriately address any warranty issues that may arise. Fairchild will not provide any warranty coverage or other assistance for parts bought from Unauthorized Sources. Fairchild is committed to combat this global problem and encourage our customers to do their part in stopping this practice by buying direct or from authorized distributors.

**PRODUCT STATUS DEFINITIONS**

**Definition of Terms**

| Datasheet Identification | Product Status        | Definition  |
|--------------------------|-----------------------|---|
| Advance Information      | Formative / In Design | Datasheet contains the design specifications for product development. Specifications may change in any manner without notice.   |
| Preliminary              | First Production      | Datasheet contains preliminary data; supplementary data will be published at a later date. Fairchild Semiconductor reserves the right to make changes at any time without notice to improve design. |
| No Identification Needed | Full Production       | Datasheet contains final specifications. Fairchild Semiconductor reserves the right to make changes at any time without notice to improve the design.   |
| Obsolete                 | Not In Production     | Datasheet contains specifications on a product that is discontinued by Fairchild Semiconductor. The datasheet is for reference information only.  |