

# Metal halide lamp with quartz burner

## HRI-TS 1000W/NDL/S/230/K12S

# Radium

Product Datasheet Date: 21.03.2023

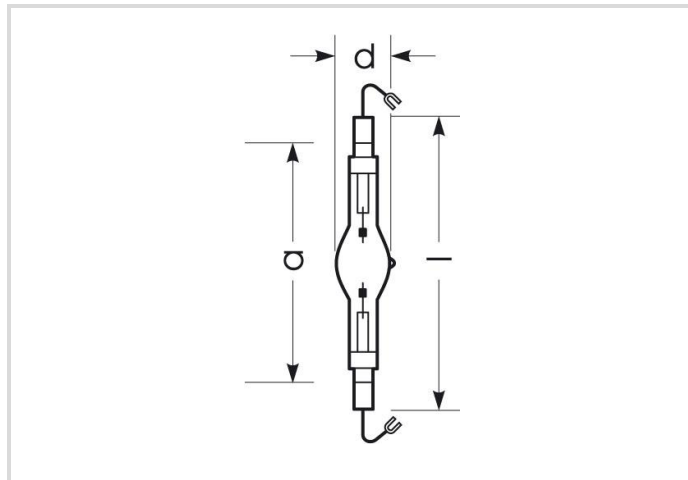

A+



90000



4400K



6 000h

## General Data

Article No.	32416593
Code	HRI-TS 1000W/NDL/S/230/K12S
Product EAN	4008597165931
Customs tariff no.	85393290
Box quantity (pcs.)	10
EAN Box	4008597465932
Gross weight of box in kg	1.446
Length of box in m	0.4
Width of box in m	0.17
Height of box in m	0.27
ETIM class	EC000037
ETIM class name	Halogen metal halide lamp without reflector
Weight	62 g
Product status	<span style="color: green;">●</span> Active

## Electric Parameters

Rated wattage	1000.0 W
Lamp nominal wattage	1 kW

## Electric Parameters

Lamp voltage	120 V
Mains voltage	230 V
Ignition voltage	4.0 up to 5.0
Hot restrike voltage	36 kV
Lamp's nominal current	9.7 A
Nominal choke current	9.5 A
Compensation capacitor for 50Hz operation	85 µF
Running up current max.	190%
Fuse	Delay-action; min. double nominal current
dimnable	No
Controllable (in suitable circuit)	No

## Light Application Parameters

Luminous flux	90000 lm
Rated lamp luminous flux	90000 lm
Luminous efficiency	90 lm/W
Radium light colour	Neutral white de luxe
Colour temperature	4400 K
Color rendering index Ra	85
Lumen maintenance at 2000h	0.91
Lumen maintenance at 4000h	0.86
Lumen maintenance at 6000h	0.84

## Service Life

Average nominal lifespan	6000 h
Lamp survival factor at 2000h	0.95
Lamp survival factor at 4000h	0.87
Lamp survival factor at 6000h	0.50

## Specification

Energylabel notice	old label, no EPREL registration, no EU data sheet
Energylabel A++ to E	A+
Diameter	36 mm
Length max.	187 mm
Total length	187 mm
Burning position	p15

# Metal halide lamp with quartz burner

HRI-TS 1000W/NDL/S/230/K12S

**Radium**

## Specification

Mercury content	75.0 mg
Model	Clear
Base	K12s-36
Colour	White

## Notes on Operation

Burning position	p15
------------------	-----

## Information especially for EPREL

Energylabel notice	old label, no EPREL registration, no EU data sheet
--------------------	--

## Miscellaneous

EU Directive	TIM
--------------	-----

## Notes

MH short arc lamp clear, light colour NDL, high luminous flux, base K12s. Operation in enclosed luminaire, with ballast and (hot restrike)ignitor.

Please, refer to [www.radium.de/recycling](http://www.radium.de/recycling) for notes on disposal of burned-out lamps as well as lamp breakage.

The "lifespan L70" described for LED lamps indicates the number of hours when the luminous flux has decreased to 70% of its initial value.

The optimal field 'info about service life' contains the frame conditions according to standards based on which the specific service life has been determined. So, for example, "12B50, 50Hz" means that the mean service life (B50) has been determined with a 12h switching cycle at mains (frequency 50Hz), "3B50, HF" is based on a 3h switching cycle at electronic control gear (high frequency).

### Base



K12s-36  
IEC/EN 60061-1  
Sheet 7004-168-1

### Spectrum

Natural daylight is a mixture of direct sunlight and the light of the sky. Therefore, its spectral composition changes permanently due to the changing time of day. The standardised light classification D65 corresponds to a daylight with a colour temperature of approximately 6500 K.

Every discharge lamp type has got an individual spectral power distribution according to its chemical filling. From this result important properties light colour or colour rendering.

Should the spectral lines be very close together the lamp presumably has got a very good colour rendering index, so, Ra might be near 100. Does the spectrum rather look like single lines or frayed out the colour rendering of the lamp will probably be not as good.

If number and height of the spectral lines within the blue range (around 400 nm) prevails it might be a lamp with a rather cold light colour like for example daylight. On the other hand, should the red (around 700 nm) or the red and yellow (around 600 nm) range be dominant one can assume that the lamp will be a rather warm light colour like WDL.

After the lamp start a metal halide lamp needs about 2-4 minutes time to reach its full luminous flux, all colours in the spectrum are within the discharge arc then.

Visible region from 380 to 780 nm; height of graph corresponding with relative spectral emission (400mW/klm) per 10nm.

# Metal halide lamp with quartz burner

HRI-TS 1000W/NDL/S/230/K12S

**Radium**

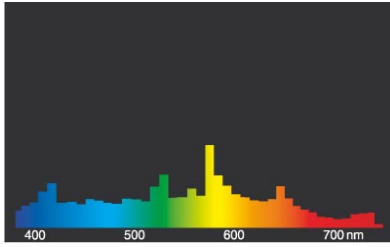

HRI.../NDL

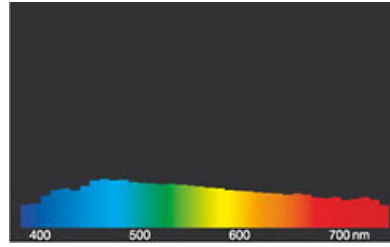

daylight(D 65)

## Circuit diagram(s)

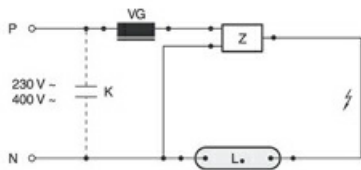

Standard circuit HID with external ignitor

Key:

L. = lamp

VG = electromagnetic ballast (KVG/VVG)

P = phase

N = zero potential

K = p. f. correction capacitor

Z = ignitor

The required control gear (here ignitor and ballast) for the lamps operation is usually mounted in the suitable luminaire in an appropriate electric circuit. Changes of any kind are to be conducted by qualified and specialised staff, only. Thus, this circuit example is to be understood merely as a technical background information for interested users.

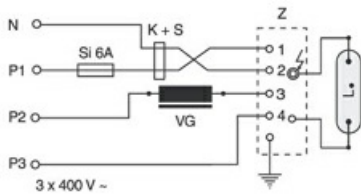

Circuit for 400V-HID-lamps suitable for hot restrike

Key:

L. = lamp

VG = electromagnetic ballast (KVG/VVG)

P = phase

N = zero potential

K = p. f. correction capacitor

Z = ignitor

S = fuse

The required control gear (here fuse, capacitor, ignitor and ballast) for the lamps operation is usually mounted in the suitable luminaire in an appropriate electric circuit. Changes of any kind are to be conducted by qualified and specialised staff, only. Thus, this circuit example is to be understood merely as a technical background information for interested users.

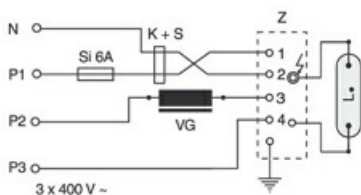

Circuit for 400V-HID-lamps suitable for hot restrike

Key:

L. = lamp

VG = electromagnetic ballast (KVG/VVG)

P = phase

N = zero potential

K = p. f. correction capacitor

Z = ignitor

S = fuse

The required control gear (here fuse, capacitor, ignitor and ballast) for the lamps operation is usually mounted in the suitable luminaire in an appropriate electric circuit. Changes of any kind are to be conducted by qualified and specialised staff, only. Thus, this circuit example is to be understood merely as a technical background information for interested users.

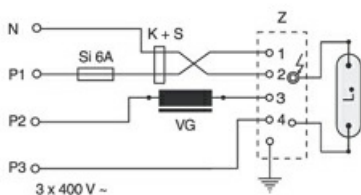

Circuit for 400V-HID-lamps suitable for hot restrike

Key:

L. = lamp

VG = electromagnetic ballast (KVG/VVG)

P = phase

N = zero potential

K = p. f. correction capacitor

Z = ignitor

S = fuse

The required control gear (here fuse, capacitor, ignitor and ballast) for the lamps operation is usually mounted in the suitable luminaire in an appropriate electric circuit. Changes of any kind are to be conducted by qualified and specialised staff, only. Thus, this circuit example is to be understood merely as a technical background information for interested users.

# Metal halide lamp with quartz burner

HRI-TS 1000W/NDL/S/230/K12S

# Radium

understood merely as a technical background information for interested users.

## Special features



## General notes

The technical design data in accordance with DIN and IEC. The producer does not take any responsibility for damage to persons or property in case of unsuitable operation or handling of the product. Operating data and dimensions are valid within the usual tolerances. Related lamp types (different bases, mains voltages) may be available on request. Sale and delivery are effected in accordance with the Radium Terms of Delivery and Payment valid on the day of conclusion of contract. Packing units offer economical advantages to the purchase and logistic department. Please match your quantity volume accordingly. For orders of a minimum quantity (clefts) with a lamp model the amount lower than the volume of each packaging unit, we will invoice 10 % additional charge per lamp type. Technical changes and terms of delivery are reserved. Manipulation of any kind to packaging or product is not permissible as this will violate Radium brand rights. Furthermore, technical properties of the product can change to its disadvantage or even destruction. Therefore, Radium cannot be responsible for consequential damages.

® = Registered trademark

Subject to change without notice. Errors and omissions excepted.

All technical data without guarantee.