

Data Sheet | Item Number: 765-1105/100-000

8-channel digital input/output; Profinet; DC 24 V / 2.0 A; 8xM8 connection; SlimLine

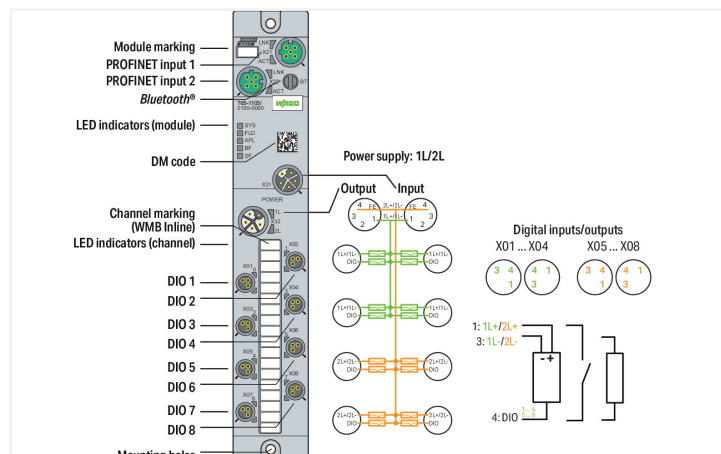

<https://www.wago.com/765-1105/100-000>



Technical data

Fieldbus	
Communication	PROFINET PROFINET IO device; 2-port switch, LLDP, MRP, SNMP
Connection technology: communication/fieldbus	2 x D-coded M12; 4-pole
Interface standard	10BASE-T/100BASE-TX; potential-free
Autonegotiation; autocrossover	Yes
PROFINET IO features	PROFINET IO device; 2-port switch, LLDP, MRP, SNMP

Device functions	
Parameter	Input filter Output current Temperature
Diagnostics	Undervoltage; overcurrent; overload; overtemperature
Device functions	Bluetooth® OPC UA server
Visualization	Android/iOS app Web server

Digital inputs/outputs	
Number of digital inputs	8
Number of digital outputs	8
Connection technology: inputs/outputs	8 x M8; 3-pole
Signal type (voltage)	24 VDC
Input characteristic	high-side switching Type 3, per IEC 61131-2
Input filter	0.2 ... 20 ms
Output current (per channel)	2 A (typ.) for DO
Supply current per port	1L/2L: 4 A (max.)

Supply (module)	
Connection technology: supply	2 x L-coded M12; 5-pole
Supply voltage	24 VDC (18 ... 31.2 V); 1L/2L
Current consumption (max.)	16000 mA
Current consumption (note)	per supply line; overload- and short-circuit-protected
Reverse voltage protection	Yes

Physical data

Width	35 mm / 1.378 inches
Height	30 mm / 1.181 inches
Depth	210 mm / 8.268 inches

Mechanical Data

Weight	390 g
Conformity marking	CE

Environmental requirements

Ambient temperature (operation)	-25 ... +70 °C
Surrounding air temperature (storage)	-40 ... +80 °C
Protection type	IP67
Protection class	III per EN 61140, IEC 61140, VDE 0140-1
Operating altitude	0 ... 2000 m / 0 ... 6562 ft
Pollution degree (5)	3 (EN 60664-1)
Overvoltage category	II (EN 60664-1)
Relative humidity (without condensation)	95 %
Vibration resistance	5g per IEC 60068-2-6
Shock resistance	Short-term: 50g/11 ms/half-sine per IEC 60068-2-27; Long-term: 30g/6 ms/half-sine per IEC 60068-2-29
EMC immunity to interference	per EN 61000-6-2
EMC emission of interference	per EN 61000-6-4

Commercial data

ETIM 8.0	EC001599
ETIM 7.0	EC001599
PU (SPU)	1 pcs
Packaging type	Box
Country of origin	DE
GTIN	4055143949705
Customs tariff number	85371098990

Downloads

Environmental Product Compliance

Compliance Search

Environmental Product
Compliance
765-1105/100-000



Documentation

Manual

Product Manual 8-
Channel Digital Input/
Output; Profinet

V 2.2.0
19.07.2022

pdf
7426.42 KB



System Description

WAGO I/O System Field;
General Product Infor-
mation

pdf
1009.23 KB



Instruction Leaflet			
I/O System Field package insert	15.12.2021	pdf 1083.98 KB	↓

CAD/CAE-Data

CAD data			
2D/3D Models 765-1105/100-000			↓

CAE data	
EPLAN Data Portal 765-1105/100-000	↓

ZUKEN Portal 765-1105/100-000	↓
----------------------------------	-------------------

Runtime Software

Firmware			
0765-x1xx, Profinet IO-Field	V 02 23.07.2021	zip 1556.58 KB	↓

Libraries

Device Description File			
750-916; GSD-Dateien der Version 2.x für PRO-FINET/ Serie 750/753, 765, 767 und 852	2.9 15.10.2021	zip 2455.88 KB	↓
Gerätebeschreibungsdateien 765-41xx, 765-11xx, PROFINET	V1_1_0_20	zip 26.83 KB	↓

1 Compatible Products

1.1 Required Accessories

1.1.1 Cover

1.1.1.1 Cover



Item No.: 756-8103
M12 protective cap; for unused plugs

Item No.: 756-8102
M12 protective cap; for unused sockets

Item No.: 756-8101
M8 protective cap; for unused sockets

1.1.2 Marking

1.1.2.1 Marker



Item No.: 2009-115

WMB-Inline; for Smart Printer; 1500 pieces on roll; stretchable 5 - 5.2 mm; plain; snap-on type; white

1.1.2.2 Marking strip



Item No.: 2009-110

Marking strips; for Smart Printer; on reel; not stretchable; plain; snap-on type; white

1.1.3 Tool

1.1.3.1 Assembly tool



Item No.: 206-701

Torque wrench M8 and M12; Assembly kit

1.2 Optional Accessories

1.2.1 Cables and connectors

1.2.1.1 Adapter



Item No.: 756-9503/040-000

Accessories; 4-pole



Item No.: 756-9504/040-000

Accessories; 4-pole

1.2.1.2 Configurable connectors



Item No.: 756-9105/030-000

Fitted pluggable connector; 3-pole; M8 plug, right angle; IDC technology



Item No.: 756-9102/030-000

Fitted pluggable connector; 3-pole; M8 plug, straight; IDC technology



Item No.: 756-9701/050-000

Fitted pluggable connector; 5-pole, shielded; M12 plug, straight; IDC technology



Item No.: 756-9711/050-000

Fitted pluggable connector; 5-pole, shielded; M12 socket, straight; IDC technology

1.2.1.3 Configurable shielded connectors



Item No.: 756-9501/040-000

Accessories; M12 plug, right angle; 4-pole































Item No.: 756-9501/060-000

Fitted pluggable connector; 4-pole, shielded; M12 plug, straight, D-coded; Spring

1.2.1.4 ETHERNET/PROFINET cable

 Item No.: 756-1202/060-100 ETHERNET cable; M12D plug; angled; 4-pole; Length: 10 m	 Item No.: 756-1202/060-020 ETHERNET cable; M12D plug; angled; 4-pole; Length: 2 m	 Item No.: 756-1202/060-200 ETHERNET cable; M12D plug; angled; 4-pole; Length: 20 m	 Item No.: 756-1202/060-050 ETHERNET cable; M12D plug; angled; 4-pole; Length: 5 m
 Item No.: 756-1204/060-010 ETHERNET cable; M12D plug; angled; M12D plug; angled; 4-pole; Length: 1 m	 Item No.: 756-1204/060-100 ETHERNET cable; M12D plug; angled; M12D plug; angled; 4-pole; Length: 10 m	 Item No.: 756-1204/060-020 ETHERNET cable; M12D plug; angled; M12D plug; angled; 4-pole; Length: 2 m	 Item No.: 756-1204/060-200 ETHERNET cable; M12D plug; angled; M12D plug; angled; 4-pole; Length: 20 m
 Item No.: 756-1204/060-030 ETHERNET cable; M12D plug; angled; M12D plug; angled; 4-pole; Length: 3 m	 Item No.: 756-1204/060-050 ETHERNET cable; M12D plug; angled; M12D plug; angled; 4-pole; Length: 5 m	 Item No.: 756-1201/060-100 ETHERNET cable; M12D plug; straight; 4-pole; Length: 10 m	 Item No.: 756-1201/060-020 ETHERNET cable; M12D plug; straight; 4-pole; Length: 2 m
 Item No.: 756-1201/060-200 ETHERNET cable; M12D plug; straight; 4-pole; Length: 20 m	 Item No.: 756-1201/060-050 ETHERNET cable; M12D plug; straight; 4-pole; Length: 5 m	 Item No.: 756-1203/060-100 ETHERNET cable; M12D plug; straight; M12D plug; straight; 4-pole; Length: 10 m	 Item No.: 756-1203/060-020 ETHERNET cable; M12D plug; straight; M12D plug; straight; 4-pole; Length: 2 m
 Item No.: 756-1203/060-200 ETHERNET cable; M12D plug; straight; M12D plug; straight; 4-pole; Length: 20 m	 Item No.: 756-1203/060-050 ETHERNET cable; M12D plug; straight; M12D plug; straight; 4-pole; Length: 5 m		

1.2.1.5 Power cable

 Item No.: 756-3504/050-100 Power cable; M12L plug; angled; 5-pole; Length: 10 m	 Item No.: 756-3504/050-150 Power cable; M12L plug; angled; 5-pole; Length: 15 m	 Item No.: 756-3504/050-020 Power cable; M12L plug; angled; 5-pole; Length: 2 m	 Item No.: 756-3504/050-050 Power cable; M12L plug; angled; 5-pole; Length: 5 m
 Item No.: 756-3504/050-075 Power cable; M12L plug; angled; 5-pole; Length: 7.5 m	 Item No.: 756-3503/050-100 Power cable; M12L plug; straight; 5-pole; Length: 10 m	 Item No.: 756-3503/050-150 Power cable; M12L plug; straight; 5-pole; Length: 15 m	 Item No.: 756-3503/050-020 Power cable; M12L plug; straight; 5-pole; Length: 2 m
 Item No.: 756-3503/050-050 Power cable; M12L plug; straight; 5-pole; Length: 5 m	 Item No.: 756-3503/050-075 Power cable; M12L plug; straight; 5-pole; Length: 7.5 m	 Item No.: 756-3502/050-100 Power cable; M12L socket; angled; 5-pole; Length: 10 m	 Item No.: 756-3502/050-150 Power cable; M12L socket; angled; 5-pole; Length: 15 m
 Item No.: 756-3502/050-020 Power cable; M12L socket; angled; 5-pole; Length: 2 m	 Item No.: 756-3502/050-050 Power cable; M12L socket; angled; 5-pole; Length: 5 m	 Item No.: 756-3502/050-075 Power cable; M12L socket; angled; 5-pole; Length: 7.5 m	 Item No.: 756-3506/050-003 Power cable; M12L socket; angled; M12L plug; angled; 5-pole; Length: 0.3 m
 Item No.: 756-3506/050-005 Power cable; M12L socket; angled; M12L plug; angled; 5-pole; Length: 0.5 m	 Item No.: 756-3506/050-010 Power cable; M12L socket; angled; M12L plug; angled; 5-pole; Length: 1 m	 Item No.: 756-3506/050-100 Power cable; M12L socket; angled; M12L plug; angled; 5-pole; Length: 10 m	 Item No.: 756-3506/050-150 Power cable; M12L socket; angled; M12L plug; angled; 5-pole; Length: 15 m
 Item No.: 756-3506/050-020 Power cable; M12L socket; angled; M12L plug; angled; 5-pole; Length: 2 m	 Item No.: 756-3506/050-050 Power cable; M12L socket; angled; M12L plug; angled; 5-pole; Length: 5 m	 Item No.: 756-3506/050-075 Power cable; M12L socket; angled; M12L plug; angled; 5-pole; Length: 7.5 m	 Item No.: 756-3501/050-100 Power cable; M12L socket; straight; 5-pole; Length: 10 m
 Item No.: 756-3501/050-150 Power cable; M12L socket; straight; 5-pole; Length: 15 m	 Item No.: 756-3501/050-020 Power cable; M12L socket; straight; 5-pole; Length: 2 m	 Item No.: 756-3501/050-050 Power cable; M12L socket; straight; 5-pole; Length: 5 m	 Item No.: 756-3501/050-075 Power cable; M12L socket; straight; 5-pole; Length: 7.5 m

1.2.1.5 Power cable



Item No.: 756-3505/050-003

Power cable; M12L socket; straight; M12L plug; straight; 5-pole; Length: 0.3 m

Item No.: 756-3505/050-005

Power cable; M12L socket; straight; M12L plug; straight; 5-pole; Length: 0.5 m

Item No.: 756-3505/050-010

Power cable; M12L socket; straight; M12L plug; straight; 5-pole; Length: 1 m

Item No.: 756-3505/050-100

Power cable; M12L socket; straight; M12L plug; straight; 5-pole; Length: 10 m



Item No.: 756-3505/050-150

Power cable; M12L socket; straight; M12L plug; straight; 5-pole; Length: 15 m

Item No.: 756-3505/050-020

Power cable; M12L socket; straight; M12L plug; straight; 5-pole; Length: 2 m

Item No.: 756-3505/050-050

Power cable; M12L socket; straight; M12L plug; straight; 5-pole; Length: 5 m

Item No.: 756-3505/050-075

Power cable; M12L socket; straight; M12L plug; straight; 5-pole; Length: 7.5 m

1.2.1.6 Sensor/actuator cable



Item No.: 756-5504/030-010

Sensor/Actuator cable; M12A socket; angled; M8 plug; angled; 3-pole; Length: 1 m

Item No.: 756-5504/030-020

Sensor/Actuator cable; M12A socket; angled; M8 plug; angled; 3-pole; Length: 2 m

Item No.: 756-5503/030-010

Sensor/Actuator cable; M12A socket; angled; M8 plug; straight; 3-pole; Length: 1 m

Item No.: 756-5503/030-020

Sensor/Actuator cable; M12A socket; angled; M8 plug; straight; 3-pole; Length: 2 m



Item No.: 756-5502/030-010

Sensor/Actuator cable; M12A socket; straight; M8 plug; angled; 3-pole; Length: 1 m

Item No.: 756-5502/030-020

Sensor/Actuator cable; M12A socket; straight; M8 plug; angled; 3-pole; Length: 2 m

Item No.: 756-5501/030-010

Sensor/Actuator cable; M12A socket; straight; M8 plug; straight; 3-pole; Length: 1 m

Item No.: 756-5501/030-020

Sensor/Actuator cable; M12A socket; straight; M8 plug; straight; 3-pole; Length: 2 m



Item No.: 756-5112/030-015

Sensor/Actuator cable; M8 plug; angled; 3-pole; Length: 1.5 m

Item No.: 756-5112/030-100

Sensor/Actuator cable; M8 plug; angled; 3-pole; Length: 10 m

Item No.: 756-5112/030-050

Sensor/Actuator cable; M8 plug; angled; 3-pole; Length: 5 m

Item No.: 756-5111/030-015

Sensor/Actuator cable; M8 plug; straight; 3-pole; Length: 1.5 m



Item No.: 756-5111/030-100

Sensor/Actuator cable; M8 plug; straight; 3-pole; Length: 10 m

Item No.: 756-5111/030-050

Sensor/Actuator cable; M8 plug; straight; 3-pole; Length: 5 m

Item No.: 756-5204/030-010

Sensor/Actuator cable; M8 socket; angled; M8 plug; angled; 3-pole; Length: 1 m

Item No.: 756-5204/030-020

Sensor/Actuator cable; M8 socket; angled; M8 plug; angled; 3-pole; Length: 2 m



Item No.: 756-5203/030-010

Sensor/Actuator cable; M8 socket; angled; M8 plug; straight; 3-pole; Length: 1 m

Item No.: 756-5203/030-020

Sensor/Actuator cable; M8 socket; angled; M8 plug; straight; 3-pole; Length: 2 m

Item No.: 756-5202/030-010

Sensor/Actuator cable; M8 socket; straight; M8 plug; angled; 3-pole; Length: 1 m

Item No.: 756-5202/030-020

Sensor/Actuator cable; M8 socket; straight; M8 plug; angled; 3-pole; Length: 2 m



Item No.: 756-5201/030-010

Sensor/Actuator cable; M8 socket; straight; M8 plug; straight; 3-pole; Length: 1 m

Item No.: 756-5201/030-020

Sensor/Actuator cable; M8 socket; straight; M8 plug; straight; 3-pole; Length: 2 m