



W9-3 Photoelectric Sensors

Best-in-class performance in VISTAL™ housing that is as tough as steel

SICK
Sensor Intelligence.

W9-3 – Performance in VISTAL™ housing

BEST IN CLASS PERFORMANCE

- Pilot LED (2nd sender LED) provides best-in-class background suppression
- PinPoint LED creates a precise and highly visible light spot
- Autocollimation optics
- Continuous threshold adaption for clear material object detection



WIDE VARIETY OF SENSOR TYPES

- Variable mounting with slotted holes for M3 or M4 screws
- Connection: M12, M8, cable, pigtailed
- Wide variety of optical options
- One sensor family to solve your varying application needs

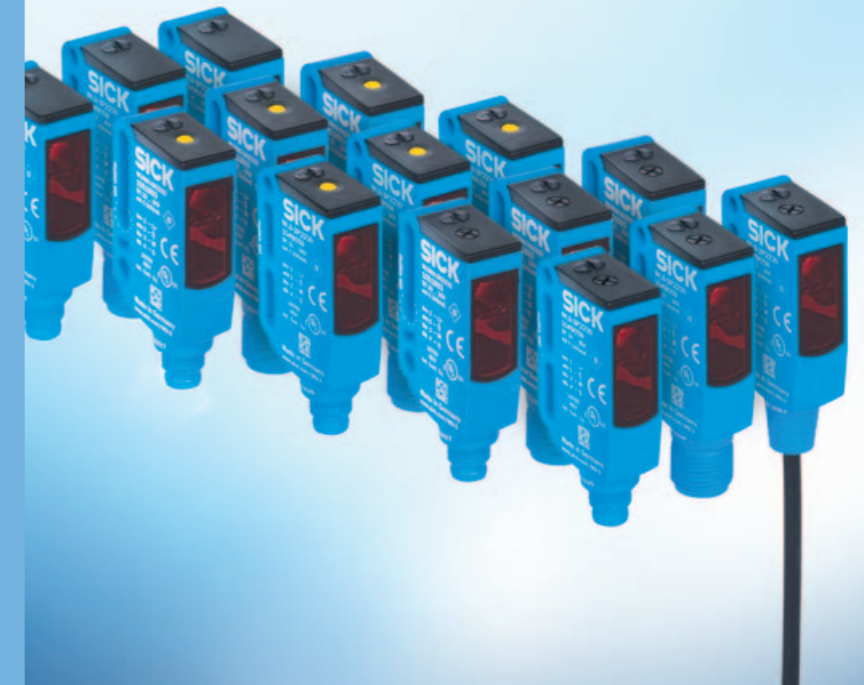

ROBUST VISTAL™ HOUSING TECHNOLOGY

- High strength fiberglass-reinforced plastic
- Inside out molding for the best leak proof protection
- Product labeled by laser marking



www.sick.com/W9-3

W9-3 – wide variety on one view



	Scanning distance/range	Light spot diameter	Screws	Page
PHOTOELECTRIC PROXIMITY SENSOR Background suppression Red light	350 mm/200 mm ¹⁾	 $\varnothing 6 \text{ mm}$ at 0 mm $\varnothing 18 \text{ mm}$ at 400 mm Distance (mm)	M3 M4	6-7 22-23
PHOTOELECTRIC PROXIMITY SENSOR Background suppression Infrared	500 mm/250 mm ¹⁾	 $\varnothing 5 \text{ mm}$ at 0 mm $\varnothing 55 \text{ mm}$ at 500 mm Distance (mm)	M3 M4	8-9 24-25
PHOTOELECTRIC PROXIMITY SENSOR - LONG RANGE Background suppression Infrared	800 mm/400 mm ¹⁾	 $\varnothing 5 \text{ mm}$ at 0 mm $\varnothing 110 \text{ mm}$ at 800 mm Distance (mm)	M3	10-11
PHOTOELECTRIC REFLEX SENSOR Autocollimation Without Teach-in Red light	4.0 m/2.5 m ²⁾	 $\varnothing 7 \text{ mm}$ at 0 mm $\varnothing 130 \text{ mm}$ at 4,000 mm Distance (mm)	M3	12-13
PHOTOELECTRIC REFLEX SENSOR Autocollimation With Teach-in Red light	5.0 m/3.0 m ²⁾	 $\varnothing 7 \text{ mm}$ at 0 mm $\varnothing 160 \text{ mm}$ at 5,000 mm Distance (mm)	M3 M4	14-15 26-27
PHOTOELECTRIC REFLEX SENSOR Autocollimation Focused Red light	0.4 m/0.3 m ²⁾	 $\varnothing 2 \text{ mm}$ at 35 mm $\varnothing 75 \text{ mm}$ at 400 mm Distance (mm)	M3	16-17
GLASS PHOTOELECTRIC REFLEX SENSOR Autocollimation For transparent objects Red light	5.0 m/3.0 m ²⁾	 $\varnothing 7 \text{ mm}$ at 0 mm $\varnothing 160 \text{ mm}$ at 5,000 mm Distance (mm)	M3 M4	18-19 28-29
THROUGH-BEAM PHOTOELECTRIC SENSOR Red light	6.0 m/5.0 m	 $\varnothing 7 \text{ mm}$ at 0 mm $\varnothing 170 \text{ mm}$ at 6,000 mm Distance (mm)	M3 M4	20-21 30-31

¹⁾ At proximity types on white/on black
²⁾ At reflex types on PL80 max./recommended



Lochbild M3

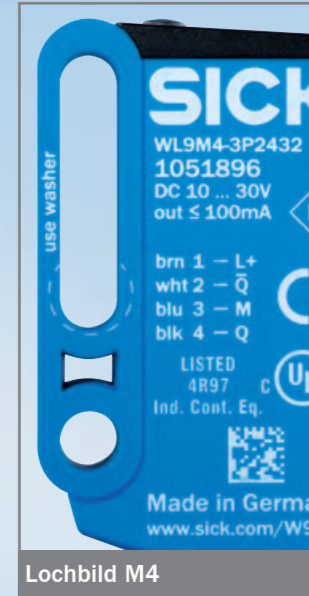

Lochbild M4

Photoelectric proximity sensors WTB9-3, red light

Scanning distance
20 ... 350 mm

Photoelectric proximity sensors

- VISTAL™ housing material is as tough as steel
- PinPoint LED creates a precise and highly visible light spot
- Pilot LED (2nd sender LED) provides best-in-class background suppression
- Variable mounting with M3 screws
- Multiple connection options

Dimensional drawing

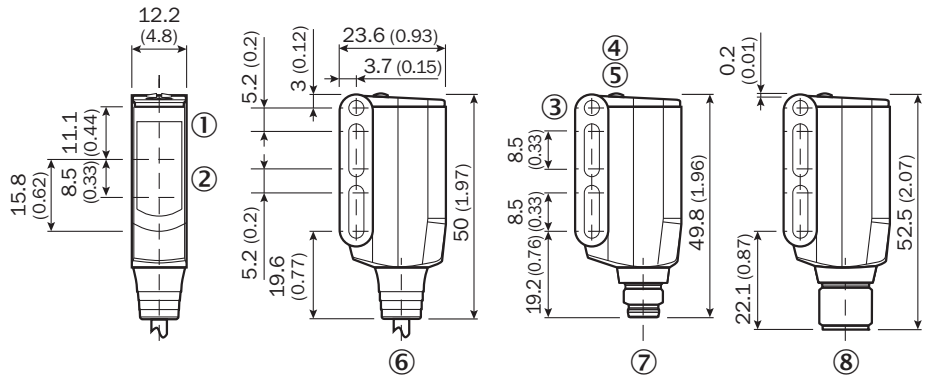

All dimensions in mm (inch)

Adjustments

All types

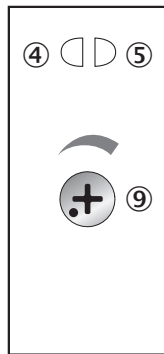

- ① Center of optical axis receiver
- ② Center of optical axis sender
- ③ Mounting hole M3 (Ø 3.1 mm)
- ④ LED indicator yellow, light reception
- ⑤ LED indicator green, Betriebsspannung
- ⑥ Cable, PVC, 2 m / 5 m or 120 mm cable with plug M12, 4-pin
- ⑦ Plug M8, 4-pin
- ⑧ Plug M12, 4-pin
- ⑨ Scanning distance adjustment

Connection types

WTB9-3P1161	WTB9-3P2261	WTB9-3P2461	WTB9-3P3461
WTB9-3P1261		WTB9-3N2461	
WTB9-3N1161			

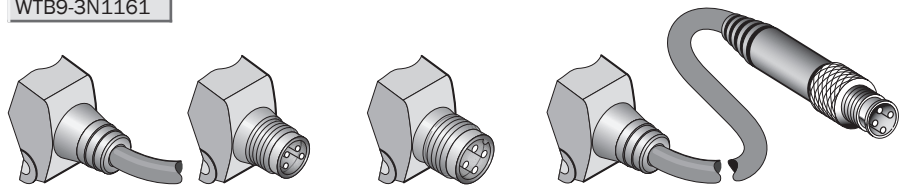

4 x 0.14 mm²

M8, 4-pin

M12, 4-pin

M12, 4-pin with 120 mm cable

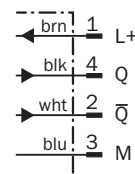
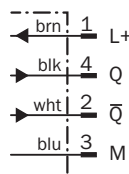
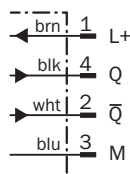
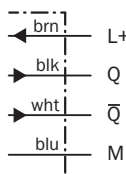

Accessories

Cables and connectors

Mounting systems

Technical data		WTB9-3	P1161	P1261	P2261	P2461	P3461	N1161	N2461			
Scanning distance, typ. max.	20 ... 350 mm ¹⁾											
Operating distance	20 ... 200 mm											
Scanning distance setting	Potentiometer, 5 turns											
Light source, type of light	PinPoint-LED, red light, 650 nm ²⁾											
Light spot diameter	4.5 mm at 75 mm distance											
Supply voltage V_S	10 ... 30 V DC ³⁾											
Ripple	< 5 V _{PP} ⁴⁾											
Current consumption	≤ 30 mA ⁵⁾											
Switching output	PNP complementary											
	NPN complementary											
Switching mode	Q = light-switching											
Output current I _A max.	≤ 100 mA ⁶⁾											
Response time	< 0.333 ms ⁷⁾											
Switching frequency, max.	1,500 Hz ⁸⁾											
Connection type	Cable, PVC, 2 m ⁹⁾											
	Cable, PVC, 5 m ⁹⁾											
	Plug, M8, 4-pin											
	Plug, M12, 4-pin											
	Cable with plug, M12, 4-pin, 120 mm ⁹⁾											
Protection class	⚡											
Circuit protection	A, B, C ¹⁰⁾											
Enclosure rating	IP 66, IP 67, IP 69K											
Ambient temperature	Operation -40 °C ... +60 °C											
	Storage -40 °C ... +75 °C											
RoHS	✓											
Weight	With cable approx. 80 g											
	With plug approx. 13 g											
Housing material	VISTAL™ Tech., PA66, PMMA, PC + ABS											

- 1) Object to be detected with 90% remission (referred to standard white DIN 5033)
- 2) Average service life 100,000 h when T_A = +25 °C

- 3) Limit values, reverse polarity protected, operation in short-circuit protected network max. 8 A
- 4) May not exceed or fall short of V_S tolerances
- 5) Without load

- 6) From T_A 50 °C a max. load current of I_{L,max} 50 mA is valid
- 7) Signal transit time with resistive load
- 8) With light/dark ratio 1 : 1
- 9) Do not bend below 0 °C

- 10) A = V_S-supply connections reverse polarity protected
- B = Outputs Q and \bar{Q} short-circuit protected
- C = Interference pulse suppression

Scanning distance

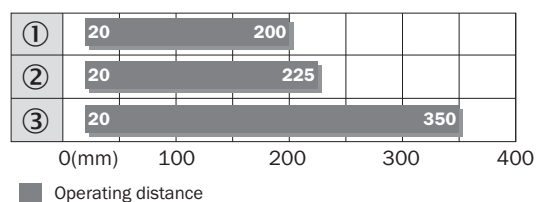

- ① Scanning distance on black, 6% remission
- ② Scanning distance on gray, 18% remission
- ③ Scanning distance on white, 90% remission

Light spot diameter

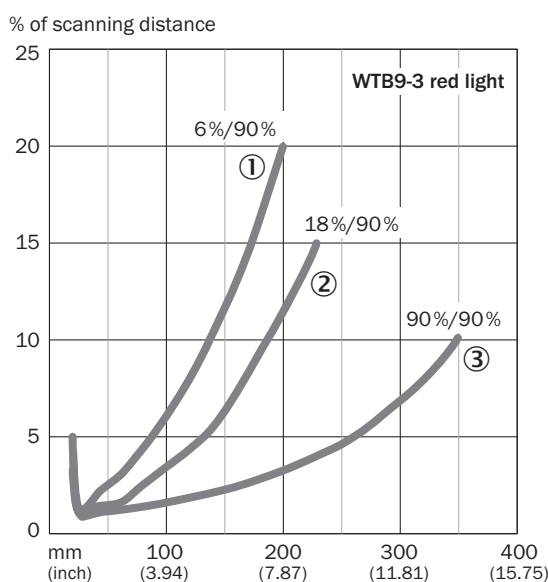
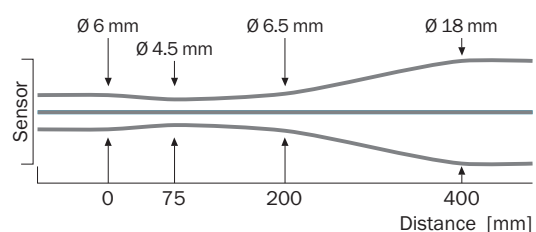

Ordering information

Model name	Part No.
WTB9-3P1161	1049043
WTB9-3P1261	1049044
WTB9-3P2261	1049047
WTB9-3P2461	1049049
WTB9-3P3461	1049051
WTB9-3N1161	1049052
WTB9-3N2461	1049053

Photoelectric proximity sensors WTB9-3, infrared

Scanning distance
20 ... 500 mm

Photoelectric proximity sensors

- VISTAL™ housing material is as tough as steel
- PinPoint LED creates a precise light spot
- Pilot LED (2nd sender LED) provides best-in-class background suppression
- Variable mounting with M3 screws
- Multiple connection options

Dimensional drawing

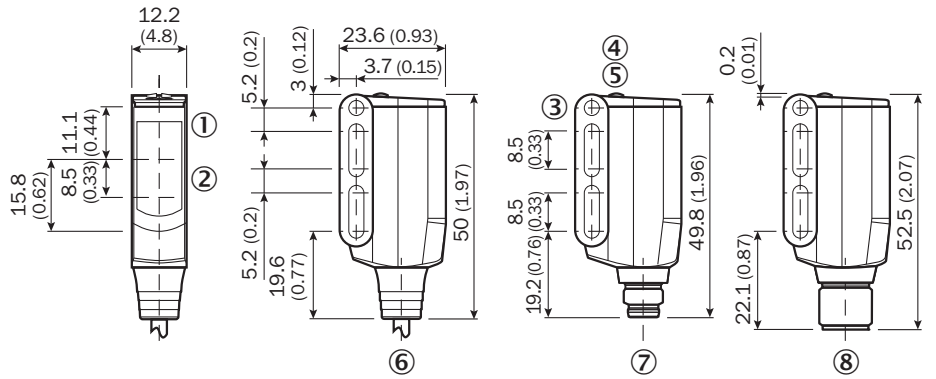

All dimensions in mm (inch)

Adjustments

All types

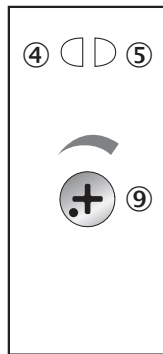

- ① Center of optical axis receiver
- ② Center of optical axis sender
- ③ Mounting hole M3 (Ø 3.1 mm)
- ④ LED indicator yellow, light reception
- ⑤ LED indicator green, power on
- ⑥ Cable, PVC, 2 m
- ⑦ Plug M8, 4-pin
- ⑧ Plug M12, 4-pin
- ⑨ Scanning distance adjustment



Connection types

WTB9-3P1111

WTB9-3P2211

WTB9-3P2411

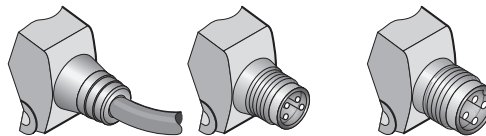

4 x 0.14 mm²

M8, 4-pin

M12, 4-pin

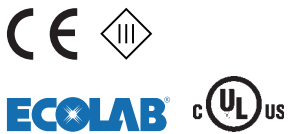
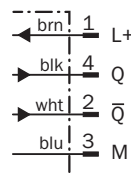
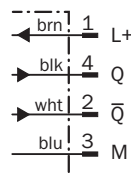
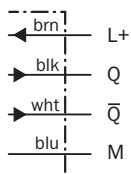

Accessories

Cables and connectors

Mounting systems

Technical data		WTB9-3	P1111	P2211	P2411						
Scanning distance, typ. max.	20 ... 500 mm ¹⁾										
Operating distance	20 ... 250 mm										
Scanning distance setting	Potentiometer, 5 turns										
Light source, type of light	LED, infrared, 850 nm ²⁾										
Light spot diameter	20 mm at 250 mm distance										
Supply voltage V_S	10 ... 30 V DC ³⁾										
Ripple	< 5 V _{PP} ⁴⁾										
Current consumption	≤ 30 mA ⁵⁾										
Switching output	PNP complementary										
Switching mode	Q = light-switching										
Output current I _A max.	≤ 100 mA										
Response time	< 0.5 ms ⁶⁾										
Switching frequency, max.	1,000 Hz ⁷⁾										
Connection type	Cable, PVC, 2 m ⁸⁾										
	Plug, M8, 4-pin										
	Plug, M12, 4-pin										
Protection class	⚡										
Circuit protection	A, B, C ⁹⁾										
Enclosure rating	IP 66, IP 67, IP 69K										
Ambient temperature	Operation -40 °C ... +60 °C										
	Storage -40 °C ... +75 °C										
RoHS	✓										
Weight	With cable approx. 80 g										
	With plug approx. 13 g										
Housing material	VISTAL™ Tech., PA66, PMMA, PC + ABS										

- 1) Object to be detected with 90% remission (referred to standard white DIN 5033)
- 2) Average service life 100,000 h when T_A = +25 °C

- 3) Limit values, reverse polarity protected, operation in short-circuit protected network max. 8 A
- 4) May not exceed or fall short of V_S tolerances

- 5) Without load
- 6) Signal transit time with resistive load
- 7) With light/dark ratio 1 : 1
- 8) Do not bend below 0 °C

- 9) A = V_S-supply connections reverse polarity protected
- B = Outputs Q and \bar{Q} short-circuit protected
- C = Interference pulse suppression

Scanning distance

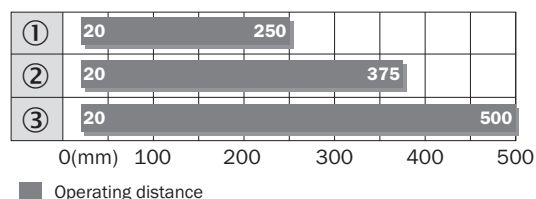

①	Scanning distance on black, 6% remission
②	Scanning distance on gray, 18% remission
③	Scanning distance on white, 90% remission

Light spot diameter

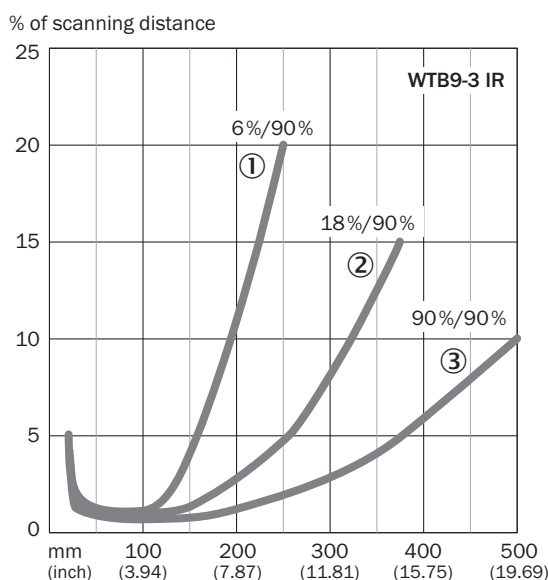
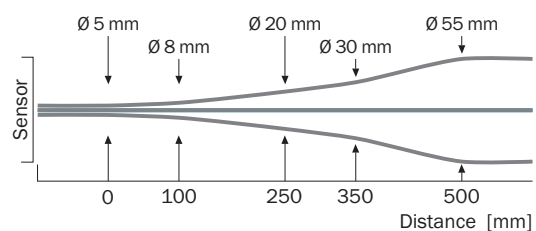

Ordering information

Model name	Part No.
WTB9-3P1111	1049042
WTB9-3P2211	1049045
WTB9-3P2411	1049048

Scanning distance
20 ... 800 mm

Photoelectric proximity sensors

- VISTAL™ housing material is as tough as steel
- PinPoint LED creates a precise light spot
- Pilot LED (2nd sender LED) provides best-in-class background suppression
- Variable mounting with M3 screws
- Multiple connection options

Dimensional drawing

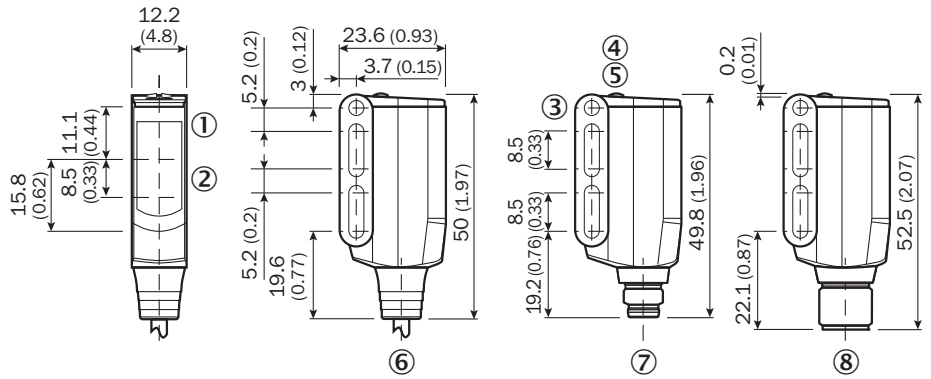

All dimensions in mm (inch)

Adjustments

All types

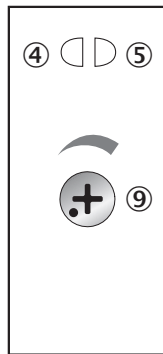

- ① Center of optical axis receiver
- ② Center of optical axis sender
- ③ Mounting hole M3 (Ø 3.1 mm)
- ④ LED indicator yellow, light reception
- ⑤ LED indicator green, power on
- ⑥ Cable, PVC, 2 m
- ⑦ Plug M8, 4-pin
- ⑧ Plug M12, 4-pin
- ⑨ Scanning distance adjustment



Connection type

WTB9-3N1111S14

WTB9-3P2211S14

WTB9-3P2411S14

WTB9-3P1111S14

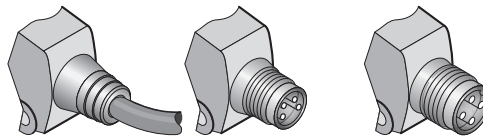

4 x 0.14 mm²

M8, 4-pin

M12, 4-pin

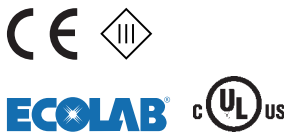
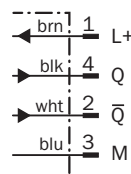
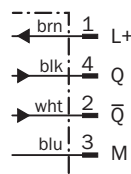
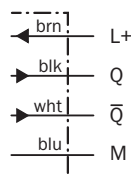

Accessories

Cables and connectors

Mounting systems

Technical data	WTB9-3	N1111S14	P2211S14	P2411S14	P1111S14						
-----------------------	--------	----------	----------	----------	----------	--	--	--	--	--	--

Scanning distance, typ. max.	20 ... 800 mm ¹⁾									
Operating distance	20 ... 400 mm									
Scanning distance setting	Potentiometer, 5 turns									
Light source, type of light	LED, infrared, 850 nm ²⁾									
Light spot diameter	40 mm at 400 mm distance									
Supply voltage V_S	10 ... 30 V DC ³⁾									
Ripple	< 5 V _{PP} ⁴⁾									
Current consumption	≤ 30 mA ⁵⁾									
Switching output	PNP complementary									
	NPN complementary									
Switching mode	Q = light-switching									
Output current I _A max.	≤ 100 mA									
Response time	< 2.5 ms ⁶⁾									
Switching frequency, max.	200 Hz ⁷⁾									
Connection type	Cable, PVC, 2 m ⁸⁾									
	Plug, M8, 4-pin									
	Plug, M12, 4-pin									
Protection class	ⓘ									
Circuit protection	A, B, C ⁹⁾									
Enclosure rating	IP 66, IP 67, IP 69K									
Ambient temperature	Operation -40 °C ... +60 °C									
	Storage -40 °C ... +75 °C									
RoHS	✓									
Weight	With cable approx. 80 g									
	With plug approx. 13 g									
Housing material	VISTAL™ Tech., PA66, PMMA, PC + ABS									

- 1) Object to be detected with 90% remission (referred to standard white DIN 5033)
- 2) Average service life 100,000 h when T_A = +25 °C
- 3) Limit values, reverse polarity protected, operation in short-circuit protected network max. 8 A
- 4) May not exceed or fall short of V_S tolerances
- 5) Without load
- 6) Signal transit time with resistive load
- 7) With light/dark ratio 1 : 1
- 8) Do not bend below 0 °C
- 9) A = V_S-supply connections reverse polarity protected
 B = Outputs Q and Q̄ short-circuit protected
 C = Interference pulse suppression

Scanning distance	Ordering information
--------------------------	-----------------------------

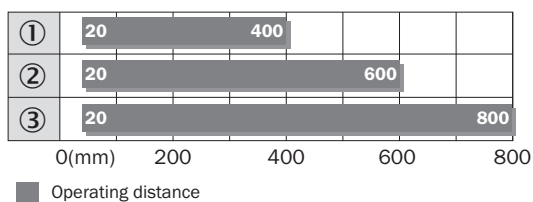

- ① Scanning distance on black, 6% remission
- ② Scanning distance on gray, 18% remission
- ③ Scanning distance on white, 90% remission

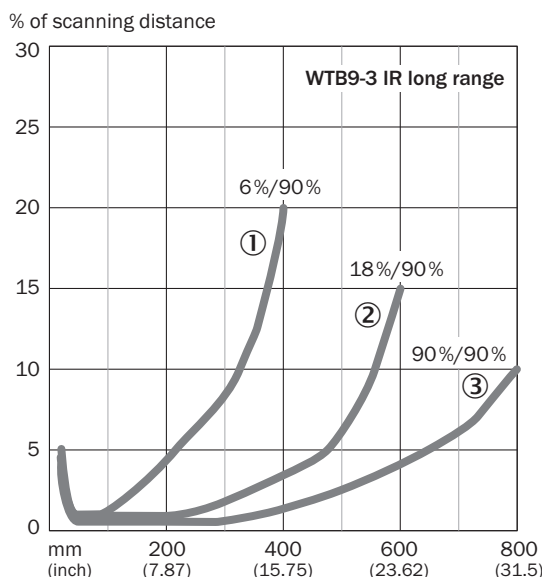
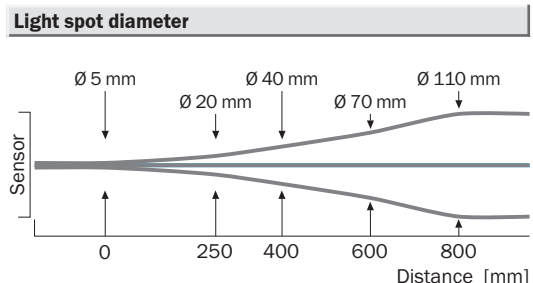

Model name	Part No.
WTB9-3N1111S14	1050948
WTB9-3P2211S14	1052171
WTB9-3P2411S14	1052172
WTB9-3P1111S14	1052173

Photoelectric reflex sensor WL9-3, red light, standard

Scanning range
0 ... 4 m
Photoelectric reflex sensor

- VISTAL™ housing material is as tough as steel
- PinPoint LED creates a precise and highly visible light spot
- Autocollimation optics
- Variable mounting with M3 screws
- Multiple connection options

Dimensional drawing

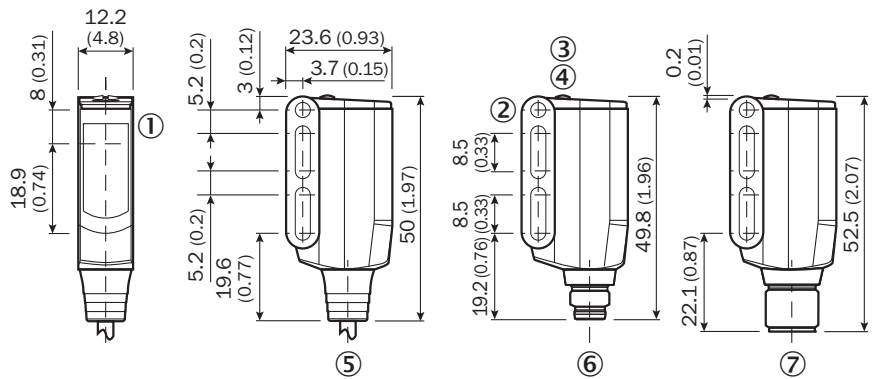

All dimensions in mm (inch)

Adjustments

All types

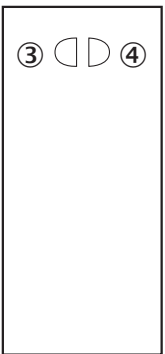

- ① Center of optical axis sender and receiver
- ② Mounting hole M3 (Ø 3.1 mm)
- ③ LED indicator yellow, light reception
- ④ LED indicator green, power on
- ⑤ Cable, PVC, 2 m or 120 mm cable with plug M12, 4-pin
- ⑥ Plug M8, 4-pin
- ⑦ Plug M12, 4-pin

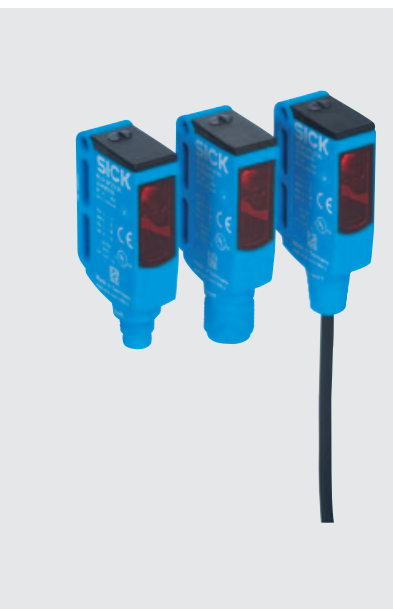

Connection types

WL9-3P1130	WL9-3P2230	WL9-3P2430	WL9-3P3430
WL9-3N1130	WL9-3N2230	WL9-3N2430	

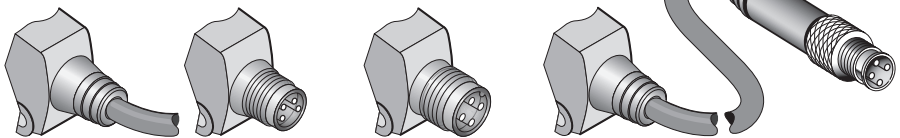

4 x 0.14 mm ²	M8, 4-pin	M12, 4-pin	M12, 4-pin with 120 mm cable
--------------------------	-----------	------------	------------------------------

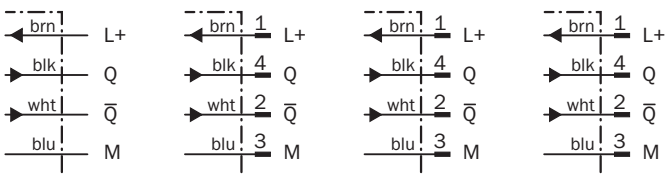

Accessories
Cables and connectors
Mounting systems
Reflectors

Technical data		WL9-3	P1130	P2230	P2430	P3430	N1130	N2230	N2430
Scanning range typ. max.	0 ... 4 m								
Operating range, recommended	0 ... 2.5 m								
Relating to	Reflector PL80A								
Light source, type of light	PinPoint-LED, red light, 650 nm ¹⁾								
Light spot diameter	45 mm at 1.5 m distance								
Polarization filter	✓								
Supply voltage V_S	10 ... 30 V DC ²⁾								
Ripple	< 5 V _{PP} ³⁾								
Current consumption	≤ 30 mA ⁴⁾								
Switching output	PNP complementary								
	NPN complementary								
Switching mode	Q = light-switching								
Output current I _A max.	≤ 100 mA								
Response time	< 0.5 ms ⁵⁾								
Switching frequency	1,000 Hz ⁶⁾								
Connection type	Cable, PVC, 2 m ⁷⁾								
	Plug, M8, 4-pin								
	Plug, M12, 4-pin								
	Cable with plug, M12, 4-pin, 120 mm ⁷⁾								
Protection class	◊								
Circuit protection	A, B, C ⁸⁾								
Enclosure rating	IP 66, IP 67, IP 69K								
Ambient temperature	Operation -40 °C ... +60 °C								
	Storage -40 °C ... +75 °C								
RoHS	✓								
Weight	With cable approx. 80 g								
	With plug approx. 13 g								
Housing material	VISTAL™ Tech., PA66, PMMA, PC + ABS								

- 1) Average service life 100,000 h when T_A = +25 °C
 2) Limit values, reverse polarity protected, operation in short-circuit protected network max. 8 A
 3) May not exceed or fall short of V_S tolerances
 4) Without load
 5) Signal transit time with resistive load
 6) With light/dark ratio 1 : 1
 7) Do not bend below 0 °C
 8) A = V_S-supply connections reverse polarity protected
 B = Outputs Q and Q̄ short-circuit protected
 C = Interference pulse suppression

Scanning range **Ordering information**

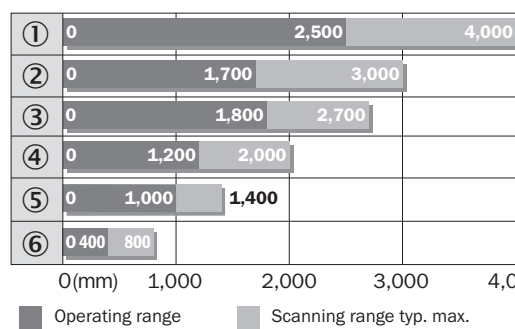

Reflector type	Operating range
1 PL80A	0 ... 2,500 mm
2 P250	0 ... 1,700 mm
3 PL40A	0 ... 1,800 mm
4 PL20A	0 ... 1,200 mm
5 PL10F	0 ... 1,000 mm
6 REF-IRF-56	0 ... 400 mm

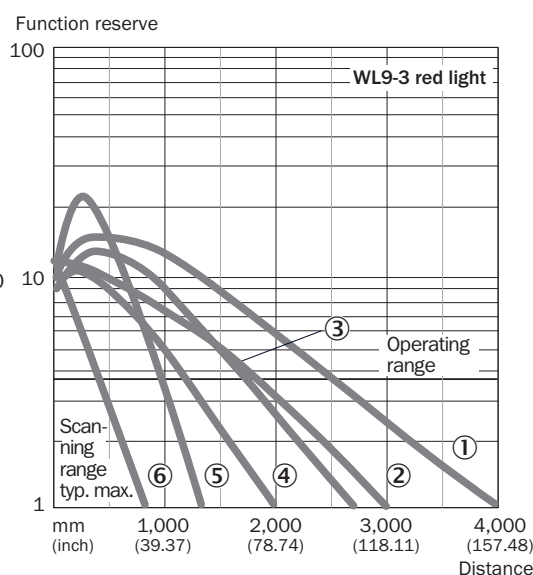

Model name	Part No.
WL9-3P1130	1049055
WL9-3P2230	1049059
WL9-3P2430	1049062
WL9-3P3430	1049066
WL93N1130	1049069
WL9-3N2230	1049071
WL9-3N2430	1049073

Light spot diameter

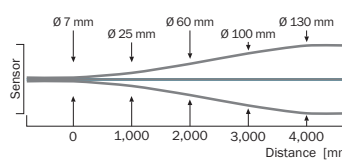

Photoelectric reflex sensor WL9-3, red light, teach-in

Scanning range
0 ... 5 m
Photoelectric reflex sensor

- VISTAL™ housing material is as tough as steel
- PinPoint LED creates a precise and highly visible light spot
- Autocollimation optics
- Variable mounting with M3 screws
- Multiple connection options

Dimensional drawing

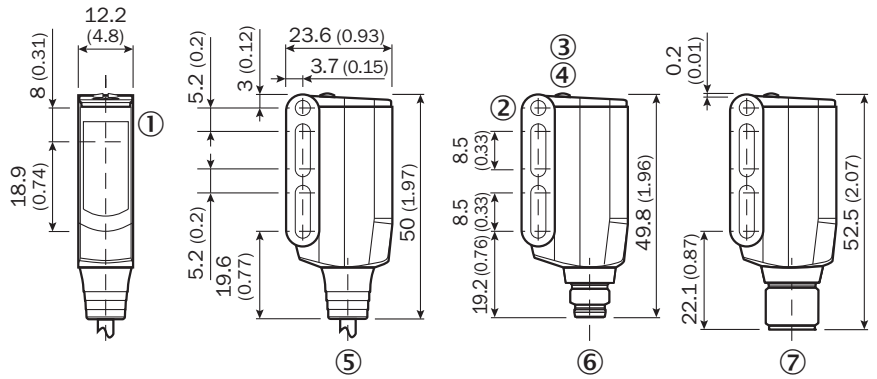

All dimensions in mm (inch)

Adjustments

All types

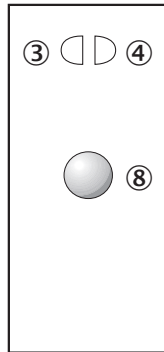

- ① Center of optical axis sender and receiver
- ② Mounting hole M3 (Ø 3.1 mm)
- ③ LED indicator yellow, light reception
- ④ LED indicator green, power on
- ⑤ Cable, PVC, 2 m / 5 m or 120 mm cable with plug M12, 4-pin
- ⑥ Plug M8, 4-pin
- ⑦ Plug M12, 4-pin
- ⑧ Teach-in button



Connection types

WL9-3P1132	WL9-3P2232	WL9-3P2432	WL9-3P3432
WL9-3P1232		WL9-3N2432	
WL9-3N1132			

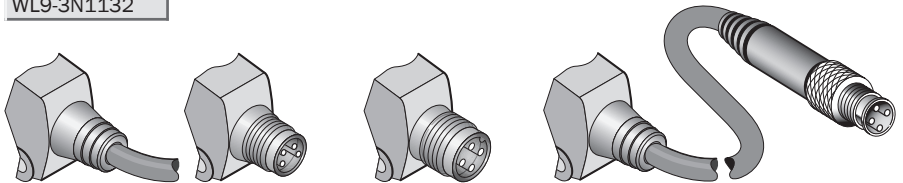

4 x 0.14 mm² M8, 4-pin M12, 4-pin M12, 4-pin with 120 mm cable

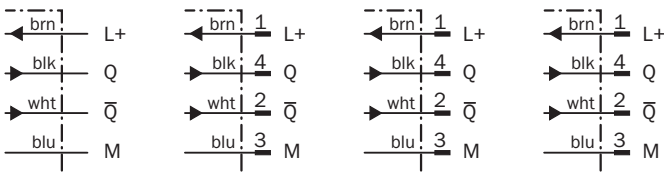

Accessories
Cables and connectors
Mounting systems
Reflectors

Technical data		WL9-3	P1132	P1232	P3432	P2232	N1132	P2432	N2432			
Scanning range typ. max.	0 ... 5 m											
Operating range, recommended	0 ... 3 m											
Relating to	Reflector PL80A											
Sensitivity setting	Teach-in button											
Light source, type of light	PinPoint-LED, red light, 650 nm ¹⁾											
Light spot diameter	45 mm at 1.5 m distance											
Polarization filter	✓											
Supply voltage V_S	10 ... 30 V DC ²⁾											
Ripple	< 5 V _{PP} ³⁾											
Current consumption	≤ 30 mA ⁴⁾											
Switching output	PNP complementary											
	NPN complementary											
Switching mode	Q = light-switching											
Output current I _A max.	≤ 100 mA											
Response time	< 0.5 ms ⁵⁾											
Switching frequency	1,000 Hz ⁶⁾											
Connection type	Cable, PVC, 2 m ⁷⁾											
	Cable, PVC, 5 m ⁷⁾											
	Plug, M8, 4-pin											
	Plug, M12, 4-pin											
	Cable with plug, M12, 4-pin, 120 mm ⁷⁾											
Protection class	⚡											
Circuit protection	A, B, C ⁸⁾											
Enclosure rating	IP 66, IP 67, IP 69K											
Ambient temperature	Operation -40 °C ... +60 °C											
	Storage -40 °C ... +75 °C											
RoHS	✓											
Weight	With cable approx. 80 g											
	With plug approx. 13 g											
Housing material	VISTAL™ Tech., PA66, PMMA, PC + ABS											

- 1) Average service life 100,000 h when T_A = +25 °C
 2) Limit values, reverse polarity protected, operation in short-circuit protected network max. 8 A
 3) May not exceed or fall short of V_S tolerances
 4) Without load
 5) Signal transit time with resistive load
 6) With light/dark ratio 1 : 1
 7) Do not bend below 0 °C
 8) A = V_S-supply connections reverse polarity protected
 B = Outputs Q and Q̄ short-circuit protected
 C = Interference pulse suppression

Scanning range

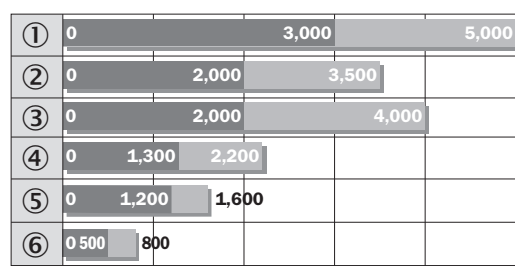

Reflector type	Operating range
1 PL80A	0 ... 3,000 mm
2 P250	0 ... 2,000 mm
3 PL40A	0 ... 2,000 mm
4 PL20A	0 ... 1,300 mm
5 PL10F	0 ... 1,200 mm
6 REF-IRF-56	0 ... 500 mm

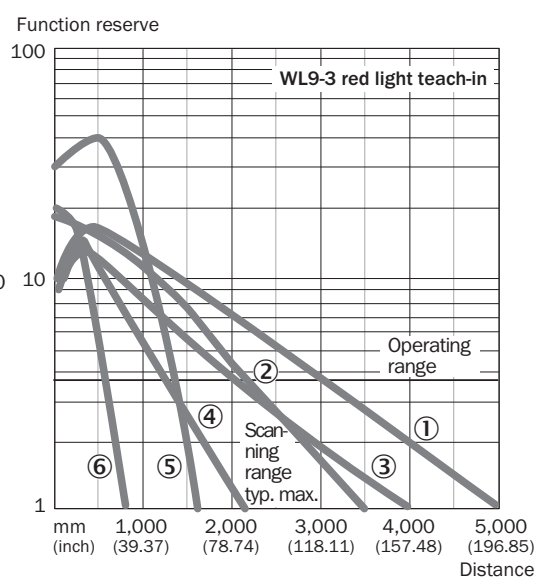

Ordering information

Model name	Part No.
WL9-3P1132	1049056
WL9-3P1232	1049057
WL9-3P3432	1049067
WL9-3P2232	1049060
WL9-3N1132	1049070
WL9-3P2432	1049063
WL9-3N2432	1049074

Light spot diameter

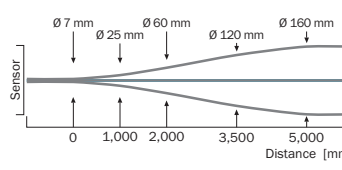

Photoelectric reflex sensor WL9-3, red light, focused

Scanning range
0 ... 0.4 m

Photoelectric reflex sensor

- VISTAL™ housing material is as tough as steel
- PinPoint LED creates a precise and highly visible light spot
- Autocollimation optics
- Variable mounting with M3 screws
- Multiple connection options

Dimensional drawing

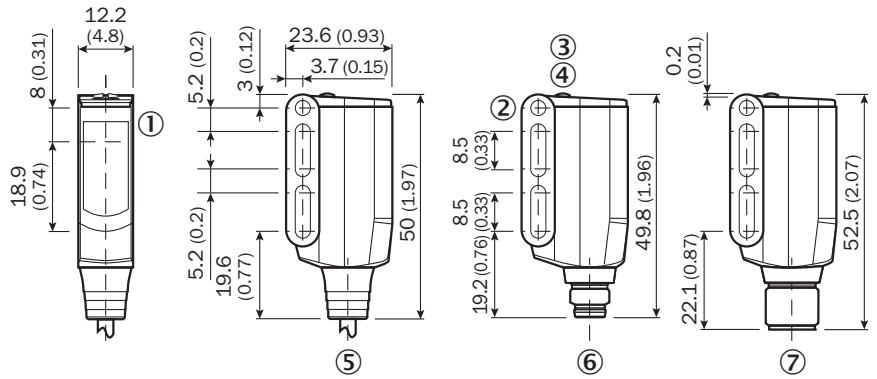

All dimensions in mm (inch)

Adjustments

All types

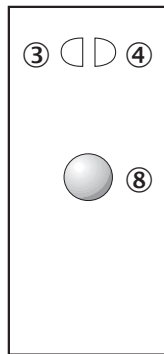

- ① Center of optical axis sender and receiver
- ② Mounting hole M3 (Ø 3.1 mm)
- ③ LED indicator yellow, light reception
- ④ LED indicator green, power on
- ⑤ Cable, PVC, 2 m or 120 mm cable with plug M12, 4-pin
- ⑥ Plug M8, 4-pin
- ⑦ Plug M12, 4-pin
- ⑧ Teach-in button



Connection types

WL9-3P1162	WL9-3P2262	WL9-3P2462	WL9-3P3462
WL9-3N1162		WL9-3N2462	

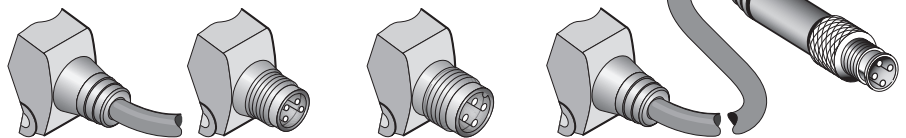

4 x 0.14 mm ²	M8, 4-pin	M12, 4-pin	M12, 4-pin with 120 mm cable
--------------------------	-----------	------------	------------------------------

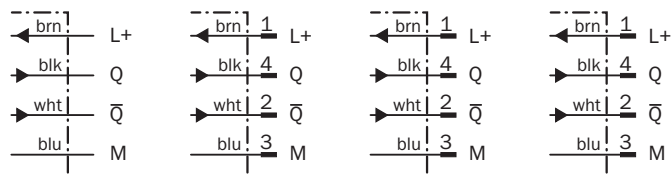

Accessories

- Cables and connectors
- Mounting systems
- Reflectors

Technical data		WL9-3	P3462	P1162	P2462	P2262	N2462	N1162				
Scanning range typ. max.	0 ... 0.4 m											
Operating range, recommended	0 ... 0.3 m											
Relating to	Reflector PL80A											
Sensitivity setting	Teach-in button											
Light source, type of light	PinPoint-LED, red light, 650 nm ¹⁾											
Light spot diameter	2.0 mm at 35 mm distance											
Polarization filter	✓											
Supply voltage V_S	10 ... 30 V DC ²⁾											
Ripple	< 5 V _{pp} ³⁾											
Current consumption	≤ 30 mA ⁴⁾											
Switching output	PNP complementary											
	NPN complementary											
Switching mode	Q = light-switching											
Output current I _A max.	≤ 100 mA											
Response time	< 0.5 ms ⁵⁾											
Switching frequency	1,000 Hz ⁶⁾											
Connection type	Cable, PVC, 2 m ⁷⁾											
	Plug, M8, 4-pin											
	Plug, M12, 4-pin											
	Cable with plug, M12, 4-pin, 120 mm ⁷⁾											
Protection class	⚡											
Circuit protection	A, B, C ⁸⁾											
Enclosure rating	IP 66, IP 67, IP 69K											
Ambient temperature	Operation -40 °C ... +60 °C											
	Storage -40 °C ... +75 °C											
RoHS	✓											
Weight	With cable approx. 80 g											
	With plug approx. 13 g											
Housing material	VISTAL™ Tech., PA66, PMMA, PC + ABS											

- 1) Average service life 100,000 h when T_A = +25 °C
- 2) Limit values, reverse polarity protected, operation in short-circuit protected network max. 8 A

- 3) May not exceed or fall short of V_S tolerances
- 4) Without load
- 5) Signal transit time with resistive load

- 6) With light/dark ratio 1 : 1
- 7) Do not bend below 0 °C

- 8) A = V_S-supply connections reverse polarity protected
- B = Outputs Q and \bar{Q} short-circuit protected
- C = Interference pulse suppression

Scanning range

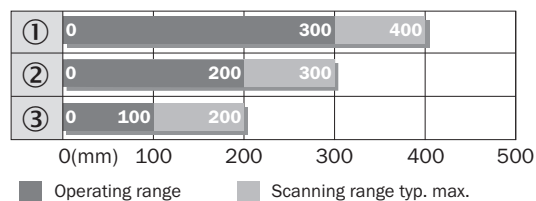

Reflector type	Operating range
① PL80A	0 ... 300 mm
② PL40A	0 ... 200 mm
③ REF-IRF-56	0 ... 100 mm

Light spot diameter

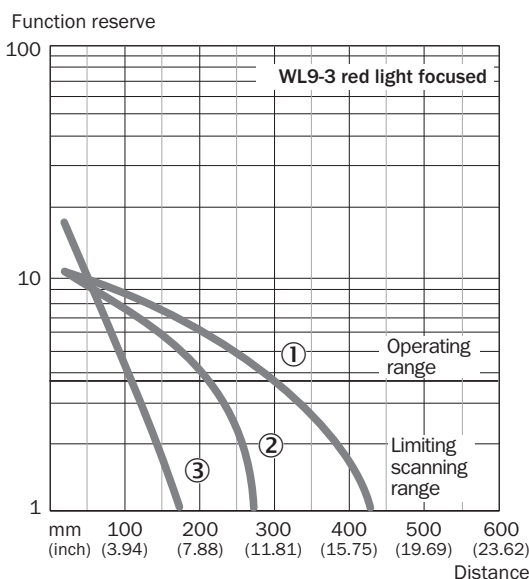
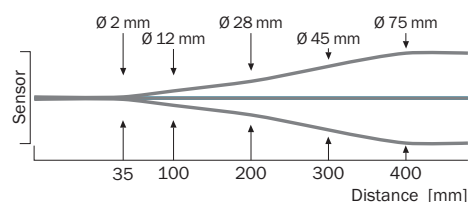

Ordering information

Model name	Part No.
WL9-3P3462	1049065
WL9-3P1162	1049054
WL9-3P2462	1049061
WL9-3P2262	1049058
WL9-3N2462	1049072
WL9-3N1162	1049068

Photoelectric reflex sensor WL9G-3, for transparent objects, red light

Scanning range
0 ... 5 m
Photoelectric reflex sensor

- VISTAL™ housing material is as tough as steel
- Continuous threshold adaption for clear material object detection
- PinPoint LED creates a precise and highly visible light spot
- Variable mounting with M3 screws
- Multiple connection options

Dimensional drawing

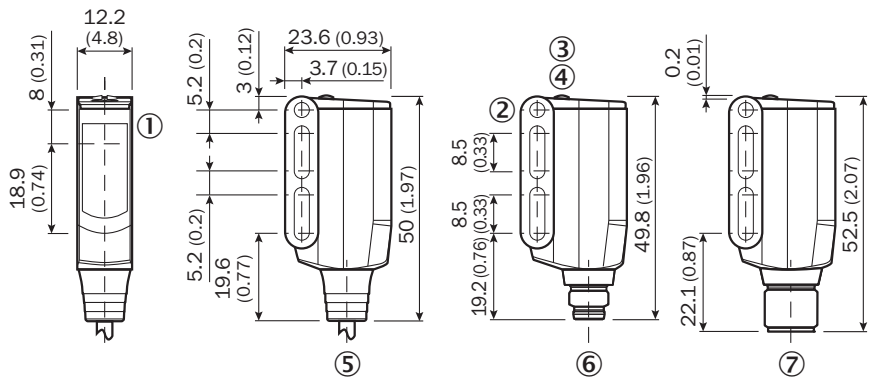

All dimensions in mm (inch)

Adjustments

All types

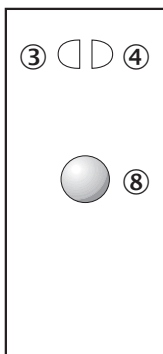

- ① Center of optical axis sender and receiver
- ② Mounting hole M3 (Ø 3.1 mm)
- ③ LED indicator yellow, light reception
- ④ LED indicator green, power on
- ⑤ Cable, PVC, 2 m or 120 mm cable with plug M12, 4-pin
- ⑥ Plug M8, 4-pin
- ⑦ Plug M12, 4-pin
- ⑧ Teach-in button



Connection types

WL9G-3P1132	WL9G-3P2232	WL9G-3P2432	WL9G-3P3432
WL9G-3N1132			

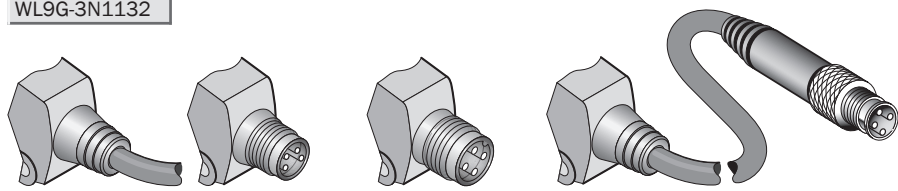

4 x 0.14 mm ²	M8, 4-pin	M12, 4-pin	M12, 4-pin with 120 mm cable
--------------------------	-----------	------------	------------------------------

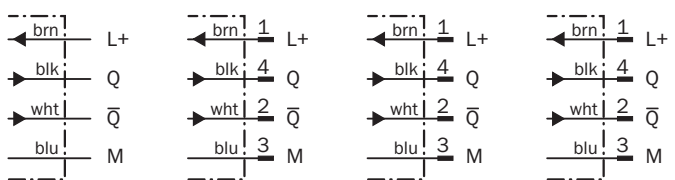

Accessories
Cables and connectors
Mounting systems
Reflectors

Technical data		WL9G-3	P1132	P2232	P2432	P3432	N1132					
Scanning range typ. max.	0 ... 5 m											
Operating range, recommended	0 ... 3 m											
Relating to	Reflector PL80A											
Sensitivity setting	Teach-in button											
Light source, type of light	PinPoint-LED, red light, 650 nm ¹⁾											
Light spot diameter	45 mm at 1.5 m distance											
Polarization filter	✓											
Supply voltage V _S	10 ... 30 V DC ²⁾											
Ripple	< 5 V _{PP} ³⁾											
Current consumption	≤ 30 mA ⁴⁾											
Switching output	PNP complementary											
	NPN complementary											
Switching mode	Q = light-switching											
Output current I _A max.	≤ 100 mA											
Response time	< 0.5 ms ⁵⁾											
Switching frequency	1,000 Hz ⁶⁾											
Connection type	Cable, PVC, 2 m ⁷⁾											
	Plug, M8, 4-pin											
	Plug, M12, 4-pin											
	Cable with plug, M12, 4-pin, 120 mm ⁷⁾											
Protection class	⚡											
Circuit protection	A, B, C ⁸⁾											
Enclosure rating	IP 66, IP 67, IP 69K											
Ambient temperature	Operation -40 °C ... +60 °C											
	Storage -40 °C ... +75 °C											
RoHS	✓											
Weight	With cable approx. 80 g											
	With plug approx. 13 g											
Housing material	VISTAL™ Tech., PA66, PMMA, PC + ABS											

- 1) Average service life 100,000 h when T_A = +25 °C
- 2) Limit values, reverse polarity protected, operation in short-circuit protected network max. 8 A
- 3) May not exceed or fall short of V_S tolerances
- 4) Without load
- 5) Signal transit time with resistive load
- 6) With light/dark ratio 1 : 1
- 7) Do not bend below 0 °C
- 8) A = V_S-supply connections reverse polarity protected
 B = Outputs Q and Q̄ short-circuit protected
 C = Interference pulse suppression

Teach-in function

Programming via teach-in button

Glass mode with dust compensation Align sensor to reflector without an object into the beam
 Press teach-in button > 2 s until the yellow signal LED is on
 Sensor is in operation

Standard operation with threshold Align sensor to reflector without an object into the beam
 Press teach-in button approx. 8 s until the yellow signal LED starts to flash
 Sensor is in operation

Ordering information

Model name	Part No.
WL9G-3P1132	1049081
WL9G-3P2232	1049082
WL9G-3P2432	1049083
WL9G-3P3432	1049084
WL9G-3N1132	1049085

Scanning range

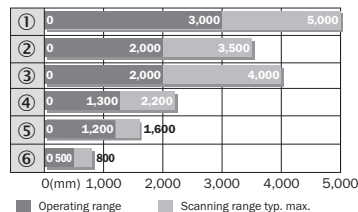

Reflector type	Operating range
① PL80A	0 ... 3,000 mm
② P250F	0 ... 2,000 mm
③ PL40A	0 ... 2,000 mm
④ PL20F	0 ... 1,300 mm
⑤ PL10F	0 ... 1,200 mm
⑥ REF-IRF-56	0 ... 500 mm

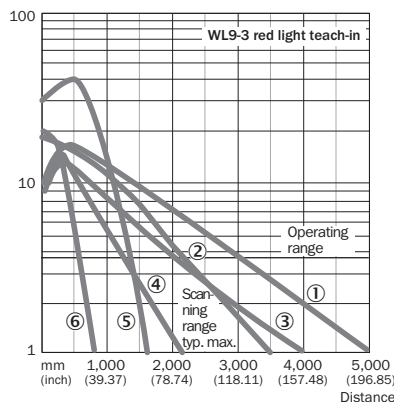

Light spot diameter

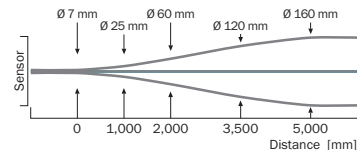

Through-beam photoelectric sensor WS/WE9-3, red light

Scanning range
0 ... 10 m

Through-beam photoelectric sensor

- VISTAL™ housing material is as tough as steel
- PinPoint LED creates a precise and highly visible light spot
- Variable mounting with M3 screws
- Multiple connection options

Dimensional drawing

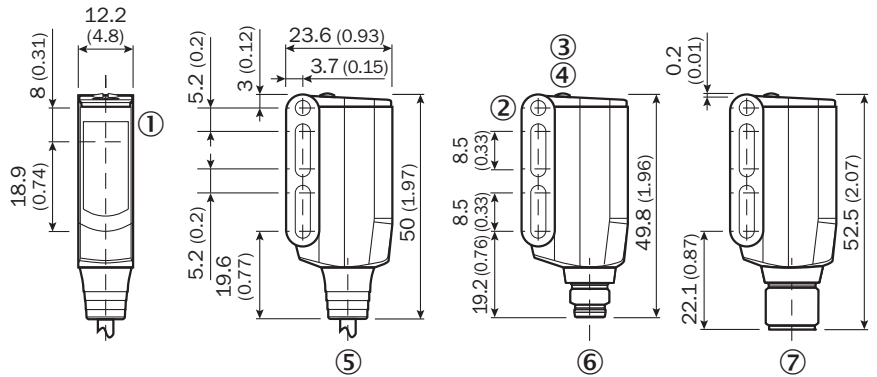

All dimensions in mm (inch)

Adjustments

All types

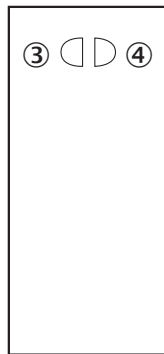

- ① Center of optical axis sender and receiver
- ② Mounting hole M3 (Ø 3.1 mm)
- ③ LED indicator yellow, light reception
- ④ LED indicator green, power on
- ⑤ Cable, PVC, 2 m or 120 mm cable with plug M12, 4-pin
- ⑥ Plug M8, 4-pin
- ⑦ Plug M12, 4-pin

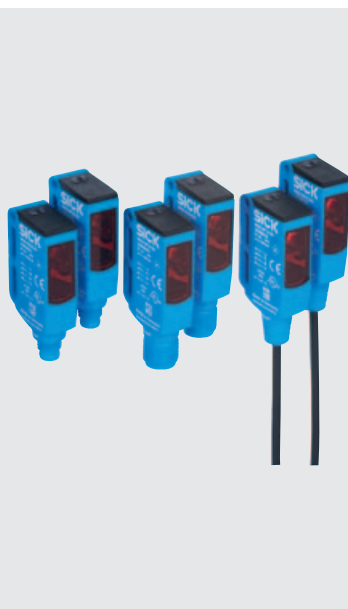

Connection types

WSE9-3P1130	WSE9-3P2230	WSE9-3P2430	WSE9-3P3430
WSE9-3N1130		WSE9-3N2430	

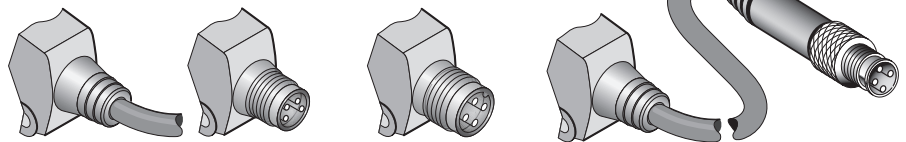

4 x 0.14 mm² M8, 4-pin M12, 4-pin M12, 4-pin with 120 mm cable

Accessories

Cables and connectors
Mounting systems

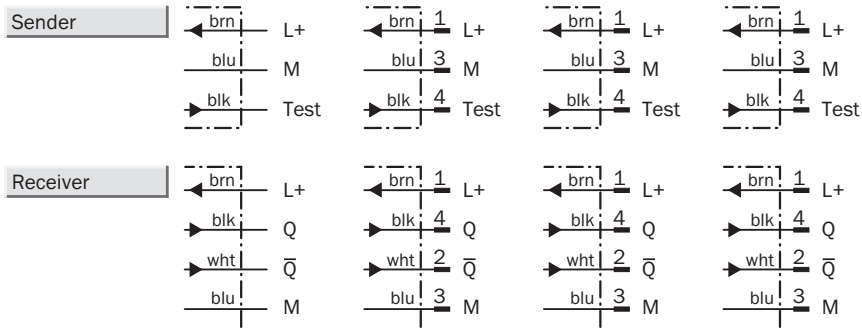

Technical data		WSE9-3	P1130	P2230	P2430	P3430	N1130	N2430				
Scanning range typ. max.	0 ... 10 m											
Operating range, recommended	0 ... 7 m											
Light source, type of light	PinPoint-LED, red light, 650 nm ¹⁾											
Light spot diameter	25 mm at 1.0 m distance											
Supply voltage V _S	10 ... 30 V DC ²⁾											
Ripple	< 5 V _{pp} ³⁾											
Current consumption	Sender: ≤ 30 mA ⁴⁾ Receiver: ≤ 20 mA ⁴⁾											
Switching output	PNP complementary NPN complementary											
Switching mode	Q = light-switching											
Test input	Sender OFF at 0 V											
Output current I _A max.	≤ 100 mA											
Response time	< 0.5 ms ⁵⁾											
Switching frequency	1,000 Hz ⁶⁾											
Connection type	Cable, PVC, 2 m ⁷⁾ Plug, M8, 4-pin Plug, M12, 4-pin Cable with plug, M12, 4-pin, 120 mm ⁷⁾											
Protection class	⚡											
Circuit protection	A, B, C ⁸⁾											
Enclosure rating	IP 66, IP 67, IP 69K											
Ambient temperature	Operation -40 °C ... +60 °C Storage -40 °C ... +75 °C											
RoHS	✓											
Weight	With cable approx. 80 g With plug approx. 13 g											
Housing material	VISTAL™ Tech., PA66, PMMA, PC + ABS											

- 1) Average service life 100,000 h when T_A = +25 °C
 2) Limit values, reverse polarity protected, operation in short-circuit protected network max. 8 A
 3) May not exceed or fall short of V_S tolerances
 4) Without load
 5) Signal transit time with resistive load
 6) With light/dark ratio 1 : 1
 7) Do not bend below 0 °C
 8) A = V_S-supply connections reverse polarity protected
 B = Outputs Q and \bar{Q} short-circuit protected
 C = Interference pulse suppression

Scanning range and functional reserves

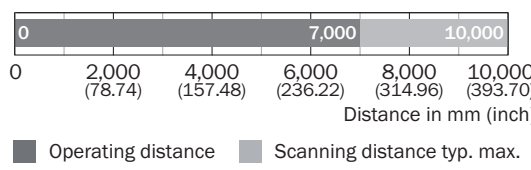

Light spot diameter

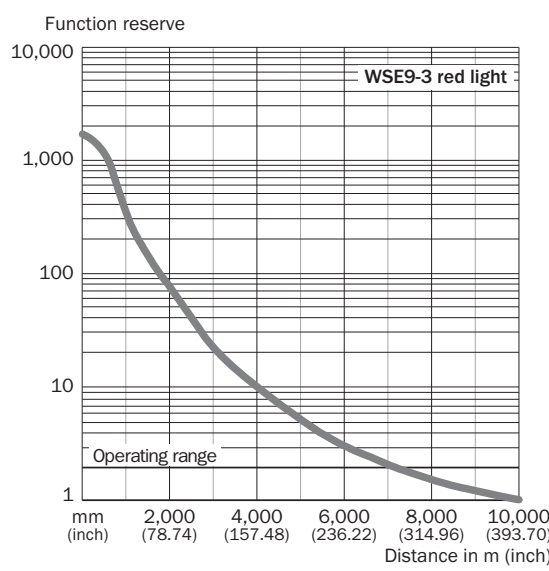
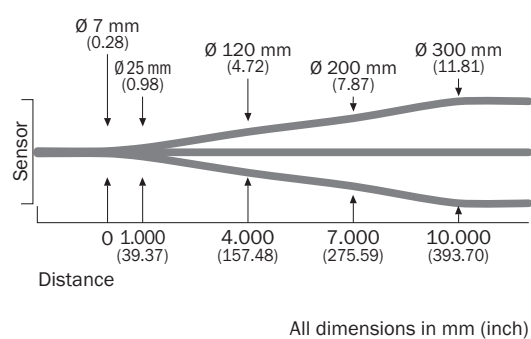

Ordering information

Model name	Part No.
WSE9-3P1130	1049075
WSE9-3P2230	1049076
WSE9-3P2430	1049077
WSE9-3P3430	1049078
WSE9-3N1130	1049079
WSE9-3N2430	1049080

Scanning distance
20 ... 350 mm

Photoelectric proximity sensors

- VISTAL™ housing material is as tough as steel
- PinPoint LED creates a precise and highly visible light spot
- Pilot LED (2nd sender LED) provides best-in-class background suppression
- Variable mounting with M4 screws
- Multiple connection options

Dimensional drawing

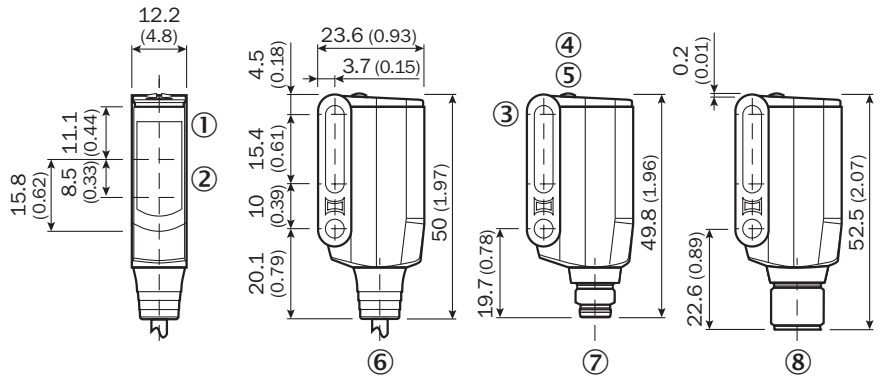

All dimensions in mm (inch)

Adjustments
All types

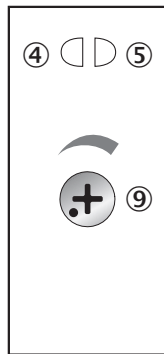

- ① Center of optical axis receiver
- ② Center of optical axis sender
- ③ Mounting hole M4 (Ø 4.1 mm)
- ④ LED indicator yellow, light reception
- ⑤ LED indicator green, power on
- ⑥ Cable, PVC, 2 m
- ⑦ Plug M8, 4-pin
- ⑧ Plug M12, 4-pin
- ⑨ Scanning distance adjustment



Connection types

WTB9M4-3P1161	WTB9M4-3P2261	WTB9M4-3P2461
WTB9M4-3N1161	WTB9M4-3N2261	

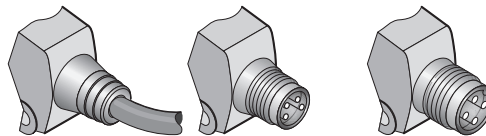

4 x 0.14 mm ²	M8, 4-pin	M12, 4-pin
--------------------------	-----------	------------

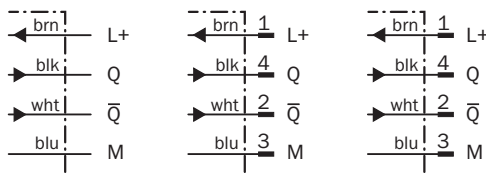

Accessories

Cables and connectors
Mounting systems

Technical data		WTB9M4-3	P1161	P2261	P2461	N1161	N2261					
Scanning distance, typ. max.	20 ... 350 mm ¹⁾											
Operating distance	20 ... 200 mm											
Scanning distance setting	Potentiometer, 5 turns											
Light source, type of light	PinPoint-LED, red light, 650 nm ²⁾											
Light spot diameter	4.5 mm at 75 mm distance											
Supply voltage V_S	10 ... 30 V DC ³⁾											
Ripple	< 5 V _{PP} ⁴⁾											
Current consumption	≤ 30 mA ⁵⁾											
Switching output	PNP complementary											
	NPN complementary											
Switching mode	Q = light-switching											
Output current I _A max.	≤ 100 mA ⁶⁾											
Response time	< 0.333 ms ⁷⁾											
Switching frequency, max.	1,500 Hz ⁸⁾											
Connection type	Cable, PVC, 2 m ⁹⁾											
	Plug, M8, 4-pin											
	Plug, M12, 4-pin											
Protection class	⊕											
Circuit protection	A, B, C ¹⁰⁾											
Enclosure rating	IP 66, IP 67, IP 69K											
Ambient temperature	Operation -40 °C ... +60 °C											
	Storage -40 °C ... +75 °C											
RoHS	✓											
Weight	With cable approx. 80 g											
	With plug approx. 13 g											
Housing material	VISTAL™ Tech., PA66, PMMA, PC + ABS											

- 1) Object to be detected with 90% remission (referred to standard white DIN 5033)
- 2) Average service life 100,000 h when T_A = +25 °C

- 3) Limit values, reverse polarity protected, operation in short-circuit protected network max. 8 A
- 4) May not exceed or fall short of V_S tolerances
- 5) Without load

- 6) From T_A 50 °C a max. load current of I_{L,max} 50 mA is valid
- 7) Signal transit time with resistive load
- 8) With light/dark ratio 1 : 1
- 9) Do not bend below 0 °C

- 10) A = V_S-supply connections reverse polarity protected
- B = Outputs Q and \bar{Q} short-circuit protected
- C = Interference pulse suppression

Scanning distance

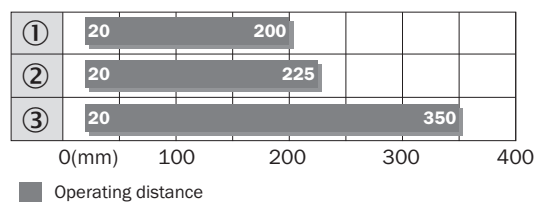

- ① Scanning distance on black, 6% remission
- ② Scanning distance on gray, 18% remission
- ③ Scanning distance on white, 90% remission

Light spot diameter

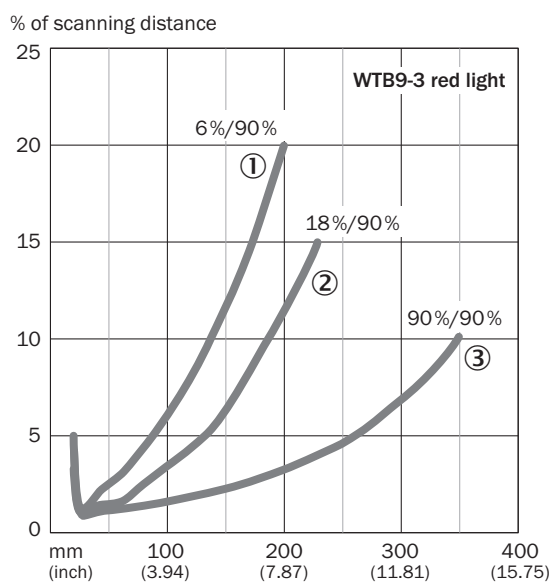
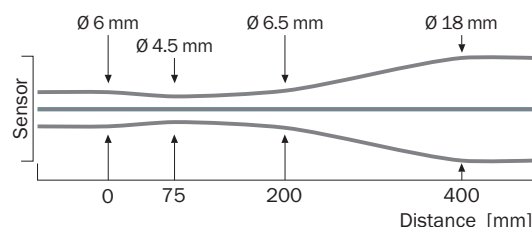

Ordering information

Model name	Part No.
WTB9M4-3P1161	1051887
WTB9M4-3P2261	1051889
WTB9M4-3P2461	1051891
WTB9M4-3N1161	1051882
WTB9M4-3N2261	1051885

Photoelectric proximity sensors WTB9M4-3, infrared

Scanning distance
20 ... 500 mm

Photoelectric proximity sensors

- VISTAL™ housing material is as tough as steel
- PinPoint LED creates a precise light spot
- Pilot LED (2nd sender LED) provides best-in-class background suppression
- Variable mounting with M4 screws
- Multiple connection options

Dimensional drawing

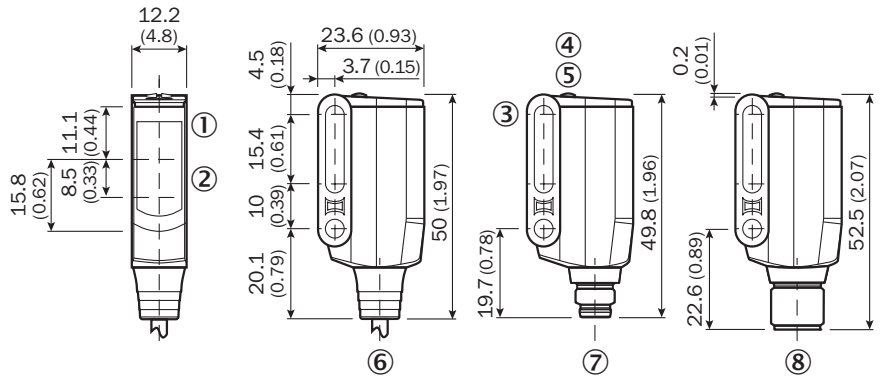

All dimensions in mm (inch)

Adjustments

All types

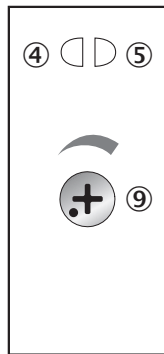

- ① Center of optical axis receiver
- ② Center of optical axis sender
- ③ Mounting hole M4 (Ø 4.1 mm)
- ④ LED indicator yellow, light reception
- ⑤ LED indicator green, power on
- ⑥ Cable, PVC, 2 m
- ⑦ Plug M8, 4-pin
- ⑧ Plug M12, 4-pin
- ⑨ Scanning distance adjustment



Connection types

WTB9M4-3P1111

WTB9M4-3P2211

WTB9M4-3P2411

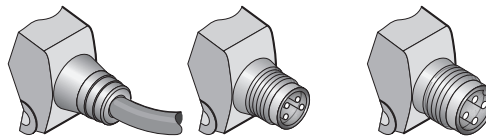

4 x 0.14 mm²

M8, 4-pin

M12, 4-pin

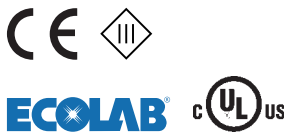
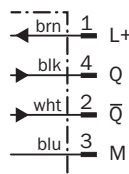
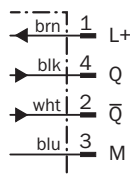
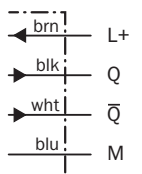

Accessories

Cables and connectors

Mounting systems

Technical data		WTB9M4-3	P1111	P2211	P2411						
Scanning distance, typ. max.	20 ... 500 mm ¹⁾										
Operating distance	20 ... 250 mm										
Scanning distance setting	Potentiometer, 5 turns										
Light source, type of light	LED, infrared, 850 nm ²⁾										
Light spot diameter	20 mm at 250 mm distance										
Supply voltage V_S	10 ... 30 V DC ³⁾										
Ripple	< 5 V _{PP} ⁴⁾										
Current consumption	≤ 30 mA ⁵⁾										
Switching output	PNP complementary										
Switching mode	Q = light-switching										
Output current I _A max.	≤ 100 mA										
Response time	< 0.5 ms ⁶⁾										
Switching frequency, max.	1,000 Hz ⁷⁾										
Connection type	Cable, PVC, 2 m ⁸⁾										
	Plug, M8, 4-pin										
	Plug, M12, 4-pin										
Protection class	⚡										
Circuit protection	A, B, C ⁹⁾										
Enclosure rating	IP 66, IP 67, IP 69K										
Ambient temperature	Operation -40 °C ... +60 °C										
	Storage -40 °C ... +75 °C										
RoHS	✓										
Weight	With cable approx. 80 g										
	With plug approx. 13 g										
Housing material	VISTAL™ Tech., PA66, PMMA, PC + ABS										

- 1) Object to be detected with 90% remission (referred to standard white DIN 5033)
- 2) Average service life 100,000 h when T_A = +25 °C

- 3) Limit values, reverse polarity protected, operation in short-circuit protected network max. 8 A
- 4) May not exceed or fall short of V_S tolerances

- 5) Without load
- 6) Signal transit time with resistive load
- 7) With light/dark ratio 1 : 1
- 8) Do not bend below 0 °C

- 9) A = V_S-supply connections reverse polarity protected
- B = Outputs Q and Q̄ short-circuit protected
- C = Interference pulse suppression

Scanning distance

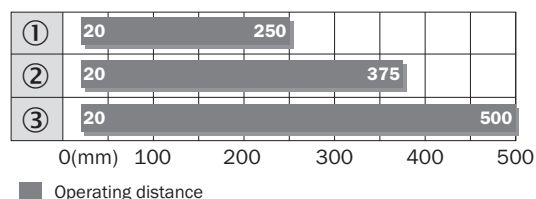

①	Scanning distance on black, 6% remission
②	Scanning distance on gray, 18% remission
③	Scanning distance on white, 90% remission

Light spot diameter

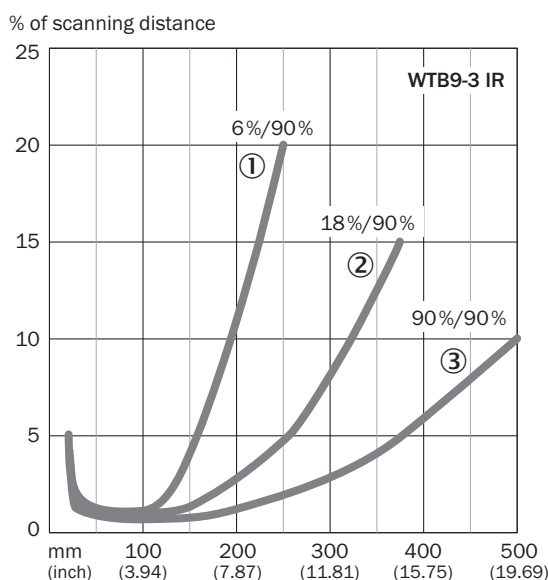
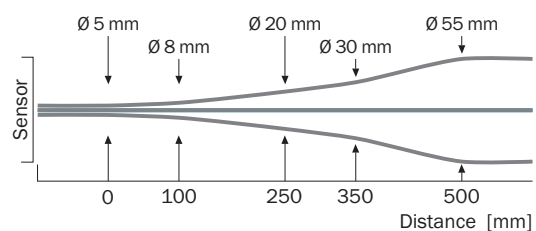

Ordering information

Model name	Part No.
WTB9M4-3P1111	1051886
WTB9M4-3P2211	1051888
WTB9M4-3P2411	1051890

Photoelectric reflex sensor WL9M4-3, red light, teach-in

Scanning range
0 ... 5 m
Photoelectric reflex sensor

- VISTAL™ housing material is as tough as steel
- PinPoint LED creates a precise and highly visible light spot
- Autocollimation optics
- Variable mounting with M4 screws
- Multiple connection options

Dimensional drawing

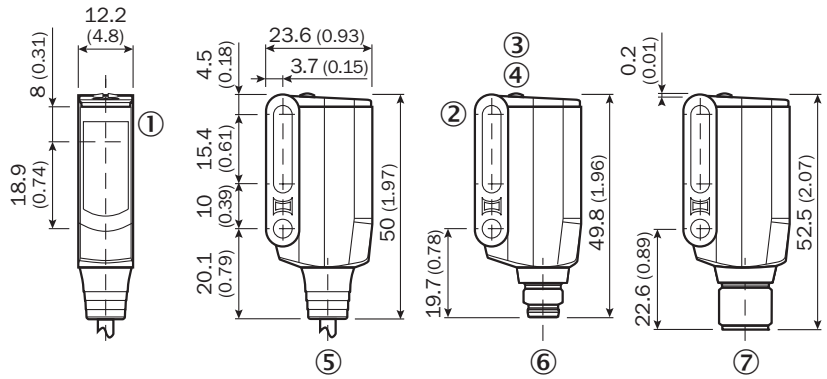

All dimensions in mm (inch)

Adjustments

All types

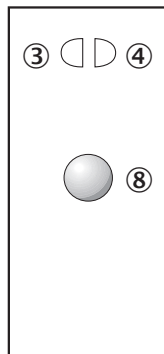

- ① Center of optical axis sender and receiver
- ② Mounting hole M4 (Ø 4.1 mm)
- ③ LED indicator yellow, light reception
- ④ LED indicator green, power on
- ⑤ Cable, PVC, 2 m or 120 mm cable with plug M12, 4-pin
- ⑥ Plug M8, 4-pin
- ⑦ Plug M12, 4-pin
- ⑧ Teach-in button



Connection types

WL9M4-3P1132	WL9M4-3V2232	WL9M4-3P2232	WL9M4-3P2432	WL9M4-3P3432
WL9M4-3N1132		WL9M4-3N2232		

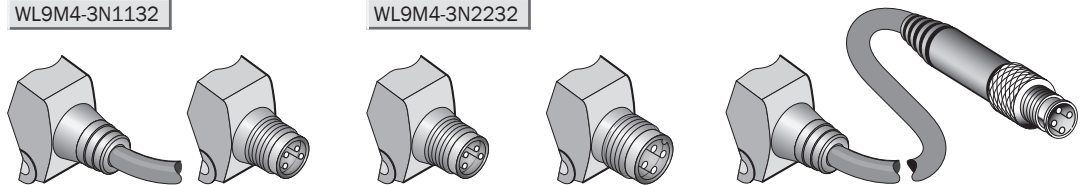

4 x 0.14 mm ²	M8, 4-pin	M8, 4-pin	M12, 4-pin	M12, 4-pin with 120 mm cable
--------------------------	-----------	-----------	------------	------------------------------

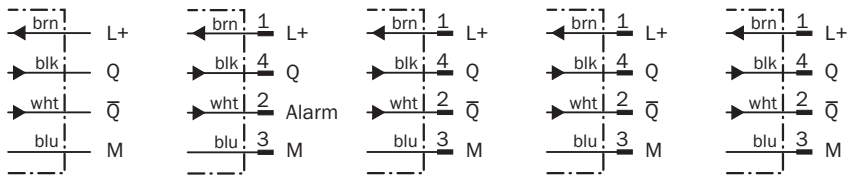

WL9M4-3V1132	WL9M4-3P2234
--------------	--------------

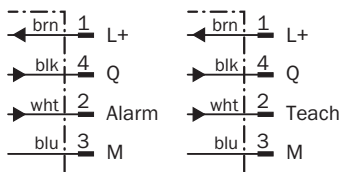

- Accessories**
- Cables and connectors
 - Mounting systems
 - Reflectors

Technical data		WL9M4-3	P1132	P2232	P2234	V1132	V2232	P2432	P3432	N1132	N2232
Scanning range typ. max.	0 ... 5 m										
Operating range, recommended	0 ... 3 m										
Relating to	Reflector PL80A										
Sensitivity setting	Teach-in button										
Light source, type of light	PinPoint-LED, red light, 650 nm ¹⁾										
Light spot diameter	45 mm at 1.5 m distance										
Polarization filter	✓										
Supply voltage V_S	10 ... 30 V DC ²⁾										
Ripple	< 5 V _{PP} ³⁾										
Current consumption	≤ 30 mA ⁴⁾										
Switching output	PNP complementary										
	PNP, VMA										
	NPN complementary										
Switching mode	Q = light-switching										
	Q = dark-switching										
Output current I_A max.	≤ 100 mA										
Response time	< 0.5 ms ⁵⁾										
Switching frequency	1,000 Hz ⁶⁾										
Connection type	Cable, PVC, 2 m ⁷⁾										
	Plug, M8, 4-pin										
	Plug, M12, 4-pin										
	Cable with plug, M12, 4-pin, 120 mm ⁷⁾										
Protection class	⚡										
Circuit protection	A, B, C ⁸⁾										
Enclosure rating	IP 66, IP 67, IP 69K										
Ambient temperature	Operation -40 °C ... +60 °C										
	Storage -40 °C ... +75 °C										
RoHS	✓										
Weight	With cable approx. 80 g										
	With plug approx. 13 g										
Housing material	VISTAL™ Tech., PA66, PMMA, PC + ABS										

- 1) Average service life 100,000 h when T_A = +25 °C
 2) Limit values, reverse polarity protected, operation in short-circuit protected network max. 8 A
 3) May not exceed or fall short of V_S tolerances
 4) Without load
 5) Signal transit time with resistive load
 6) With light/dark ratio 1 : 1
 7) Do not bend below 0 °C
 8) A = V_S-supply connections reverse polarity protected
 B = Outputs Q and Q̄ short-circuit protected
 C = Interference pulse suppression

Scanning range

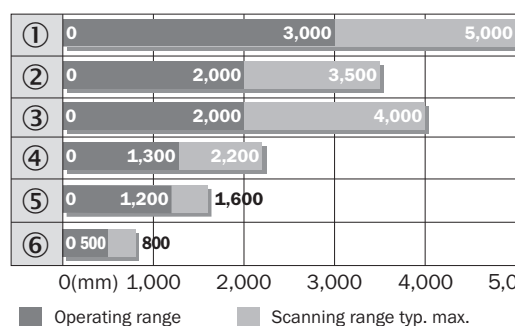

Reflector type	Operating range
1 PL80A	0 ... 3,000 mm
2 P250	0 ... 2,000 mm
3 PL40A	0 ... 2,000 mm
4 PL20A	0 ... 1,300 mm
5 PL10F	0 ... 1,200 mm
6 REF-IRF-56	0 ... 500 m

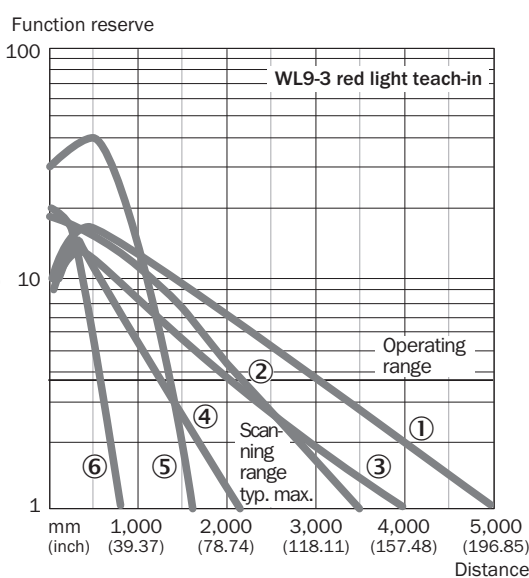

Ordering information

Model name	Part No.
WL9M4-3P1132	1051894
WL9M4-3P2232	1051895
WL9M4-3P2234	1051906
WL9M4-3V1132	1051908
WL9M4-3V2232	1051909
WL9M4-3P2432	1051896
WL9M4-3P3432	1051907
WL9M4-3N1132	1051892
WL9M4-3N2232	1051893

Light spot diameter

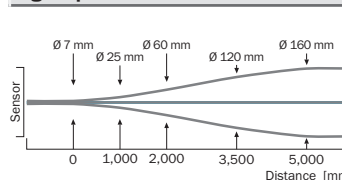

Scanning range
0 ... 5 m
Photoelectric reflex sensor

- VISTAL™ housing material is as tough as steel
- Continuous threshold adaption for clear material object detection
- PinPoint LED creates a precise and highly visible light spot
- Variable mounting with M4 screws
- Multiple connection options

Dimensional drawing

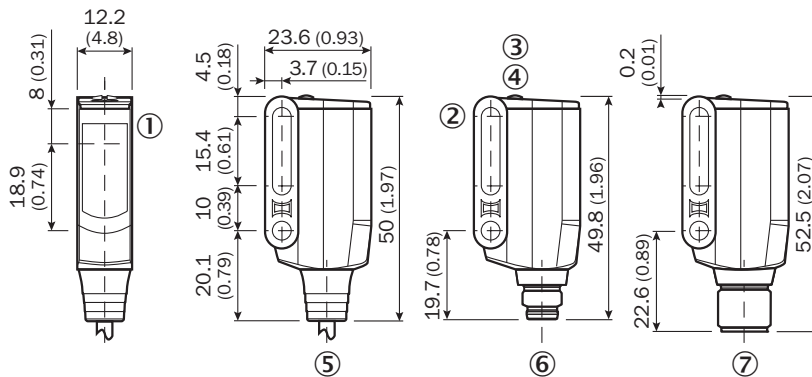

All dimensions in mm (inch)

Adjustments

All types

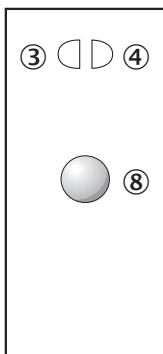

- ① Center of optical axis sender and receiver
- ② Mounting hole M4 (Ø 4.1 mm)
- ③ LED indicator yellow, light reception
- ④ LED indicator green, power on
- ⑤ Cable, PVC, 2 m or 120 mm cable with plug M12, 4-pin
- ⑥ Plug M8, 4-pin
- ⑦ Plug M12, 4-pin
- ⑧ Teach-in button



Connection types

WL9M4G-3P1132	WL9M4G-3P2232	WL9M4G-3P2432	WL9M4G-3P3432
WL9M4G-3N1132			

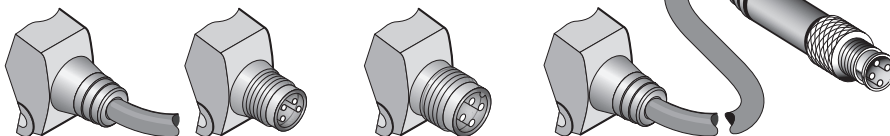

4 x 0.14 mm ²	M8, 4-pin	M12, 4-pin	M12, 4-pin with 120 mm cable
--------------------------	-----------	------------	------------------------------

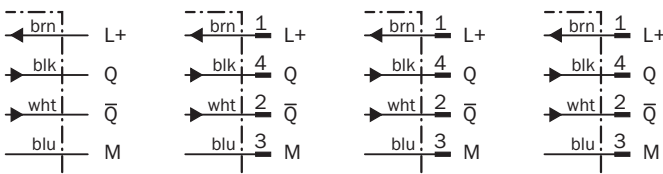

Accessories

Cables and connectors
Mounting systems
Reflectors

Technical data		WL9M4G-3	P1132	P2232	P2432	P3432	N1132					
Scanning range typ. max.	0 ... 5 m											
Operating range, recommended	0 ... 3 m											
Relating to	Reflector PL80A											
Sensitivity setting	Teach-in button											
Light source, type of light	PinPoint-LED, red light, 650 nm ¹⁾											
Light spot diameter	45 mm at 1.5 m distance											
Polarization filter	✓											
Supply voltage V _S	10 ... 30 V DC ²⁾											
Ripple	< 5 V _{PP} ³⁾											
Current consumption	≤ 30 mA ⁴⁾											
Switching output	PNP complementary											
	NPN complementary											
Switching mode	Q = light-switching											
Output current I _A max.	≤ 100 mA											
Response time	< 0.5 ms ⁵⁾											
Switching frequency	1,000 Hz ⁶⁾											
Connection type	Cable, PVC, 2 m ⁷⁾											
	Plug, M8, 4-pin											
	Plug, M12, 4-pin											
	Cable with plug, M12, 4-pin, 120 mm ⁷⁾											
Protection class	⚡											
Circuit protection	A, B, C ⁸⁾											
Enclosure rating	IP 66, IP 67, IP 69K											
Ambient temperature	Operation -40 °C ... +60 °C											
	Storage -40 °C ... +75 °C											
RoHS	✓											
Weight	With cable approx. 80 g											
	With plug approx. 13 g											
Housing material	VISTAL™ Tech., PA66, PMMA, PC + ABS											

- 1) Average service life 100,000 h when T_A = +25 °C
- 2) Limit values, reverse polarity protected, operation in short-circuit protected network max. 8 A

- 3) May not exceed or fall short of V_S tolerances
- 4) Without load
- 4) Signal transit time with resistive load

- 6) With light/dark ratio 1 : 1
- 7) Do not bend below 0 °C

- 8) A = V_S-supply connections reverse polarity protected
- B = Outputs Q and Q̄ short-circuit protected
- C = Interference pulse suppression

Teach-in function

Programming via teach-in button

Glass mode with dust compensation Align sensor to reflector without an object into the beam
 Press teach-in button > 2 s until the yellow signal LED is on
 Sensor is in operation

Standard operation with threshold Align sensor to reflector without an object into the beam
 Press teach-in button approx. 8 s until the yellow signal LED starts to flash
 Sensor is in operation

Ordering information

Model name	Part No.
WL9M4G-3P1132	1051898
WL9M4G-3P2232	1051899
WL9M4G-3P2432	1051900
WL9M4G-3P3432	1051910
WL9M4G-3N1132	1051897

Scanning range

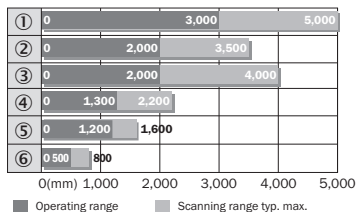

Reflector type	Operating range
① PL80A	0 ... 3,000 mm
② P250F	0 ... 2,000 mm
③ PL40A	0 ... 2,000 mm
④ PL20F	0 ... 1,300 mm
⑤ PL10F	0 ... 1,200 mm
⑥ REF-IRF-56	0 ... 500 mm

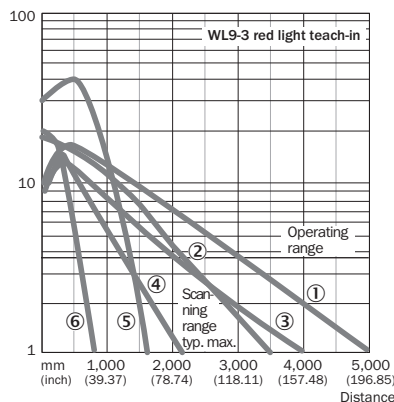

Light spot diameter

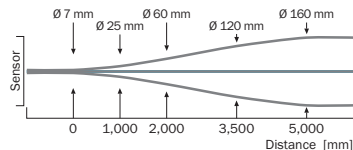

Scanning range
0 ... 10 m

Through-beam photoelectric sensor

- VISTAL™ housing material is as tough as steel
- PinPoint LED creates a precise and highly visible light spot
- Variable mounting with M4 screws
- Multiple connection options

Dimensional drawing

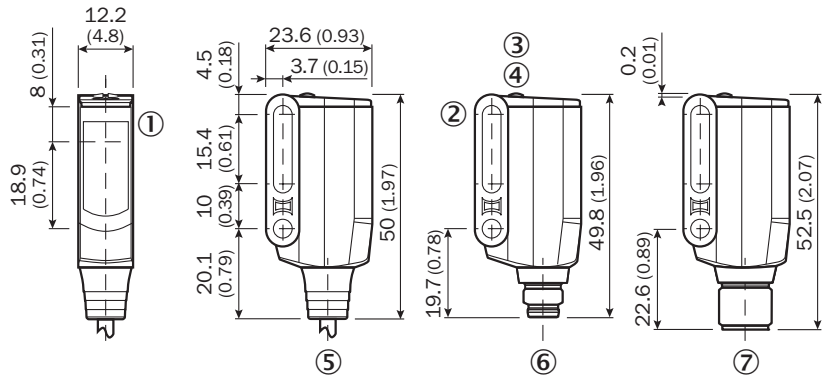

All dimensions in mm (inch)

Adjustments

All types

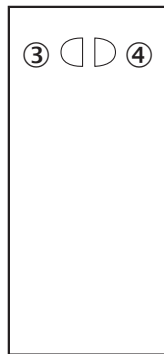

- ① Center of optical axis sender and receiver
- ② Mounting hole M4 (Ø 4.1 mm)
- ③ LED indicator yellow, light reception
- ④ LED indicator green, power on
- ⑤ Cable, PVC, 2 m
- ⑥ Plug M8, 4-pin
- ⑦ Plug M12, 4-pin

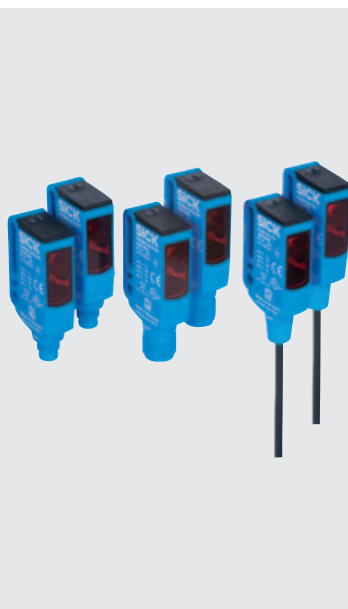

Connection types

WSE9M4-3P1130	WSE9M4-3P2230	WSE9M4-3P2430
WSE9M4-3N1130	WSE9M4-3N2230	WSE9M4-3N2430

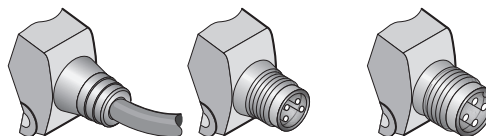

4 x 0.14 mm² M8, 4-pin M12, 4-pin

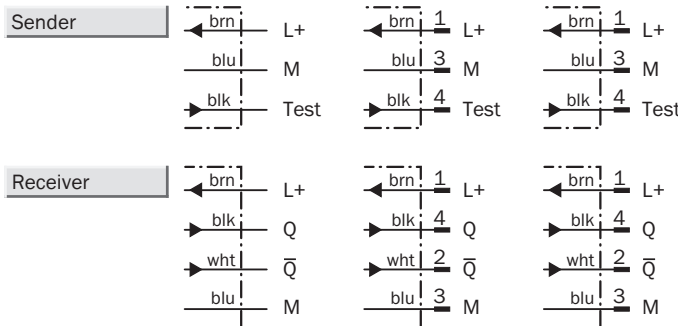

Accessories

Cables and connectors

Mounting systems



Technical data		WSE9M4-3	P1130	P2230	P2430	N1130	N2230	N2430				
Scanning range typ. max.	0 ... 10 m											
Operating range, recommended	0 ... 7 m											
Light source, type of light	PinPoint-LED, red light, 650 nm ¹⁾											
Light spot diameter	25 mm at 1.0 m distance											
Supply voltage V _S	10 ... 30 V DC ²⁾											
Ripple	< 5 V _{pp} ³⁾											
Current consumption	Sender: ≤ 30 mA ⁴⁾ Receiver: ≤ 20 mA ⁴⁾											
Switching output	PNP complementary NPN complementary											
Switching mode	Q = light-switching											
Test input	Sender OFF at 0 V											
Output current I _A max.	≤ 100 mA											
Response time	< 0.5 ms ⁵⁾											
Switching frequency	1,000 Hz ⁶⁾											
Connection type	Cable, PVC, 2 m ⁷⁾ Plug, M8, 4-pin Plug, M12, 4-pin											
Protection class	⚡											
Circuit protection	A, B, C ⁸⁾											
Enclosure rating	IP 66, IP 67, IP 69K											
Ambient temperature	Operation -40 °C ... +60 °C Storage -40 °C ... +75 °C											
RoHS	✓											
Weight	With cable approx. 80 g With plug approx. 13 g											
Housing material	VISTAL™ Tech., PA66, PMMA, PC + ABS											

- 2) Average service life 100,000 h when T_A = +25 °C
 3) Limit values, reverse polarity protected, operation in short-circuit protected network max. 8 A
 4) May not exceed or fall short of V_S tolerances
 5) Without load
 6) Signal transit time with resistive load
 7) With light/dark ratio 1 : 1
 8) Do not bend below 0 °C
 9) A = V_S-supply connections reverse polarity protected
 B = Outputs Q and Q̄ short-circuit protected
 C = Interference pulse suppression

Scanning range and functional reserves

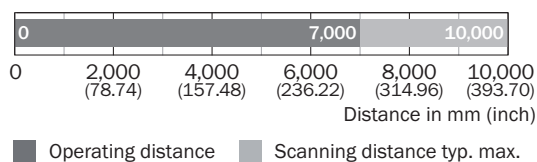

Light spot diameter

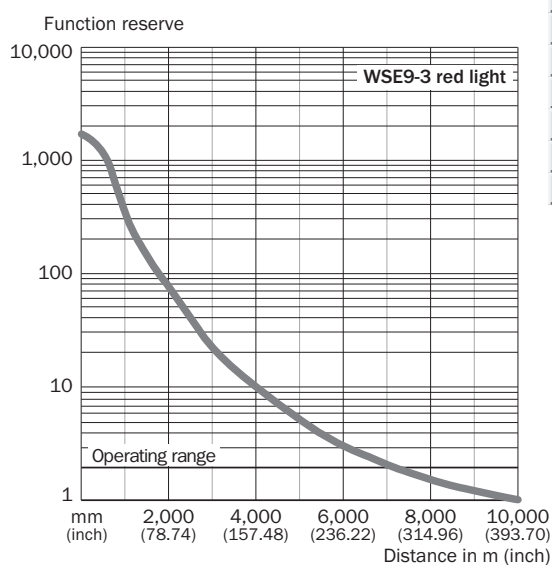
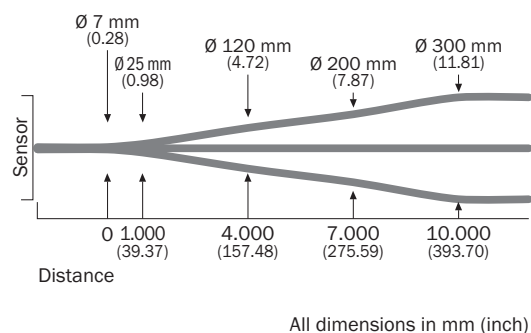

Ordering information

Model name	Part No.
WSE9M4-3P1130	1051911
WSE9M4-3P2230	1051912
WSE9M4-3P2430	1051913
WSE9M4-3N1130	1051914
WSE9M4-3N2230	1052938
WSE9M4-3N2430	1051915

Dimensional drawings and ordering information

SENSICK screw-in system M12, 4-pin, enclosure rating IP 67

Female connector M12, 4-pin, straight

Cable diameter 5 mm, 4 x 0.25 mm², sheath PVC

Model name	Part No.	Contacts	Cable length
DOL-1204-G02M	6009382	4	2 m
DOL-1204-G05M	6009866	4	5 m

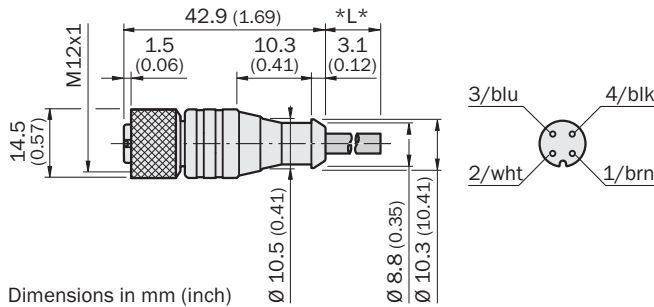

Female connector M12, 4-pin, right angle

Cable diameter 5 mm, 4 x 0.25 mm², sheath PVC

Model name	Part No.	Contacts	Cable length
DOL-1204-W02M	6009383	4	2 m
DOL-1204-W05M	6009867	4	5 m

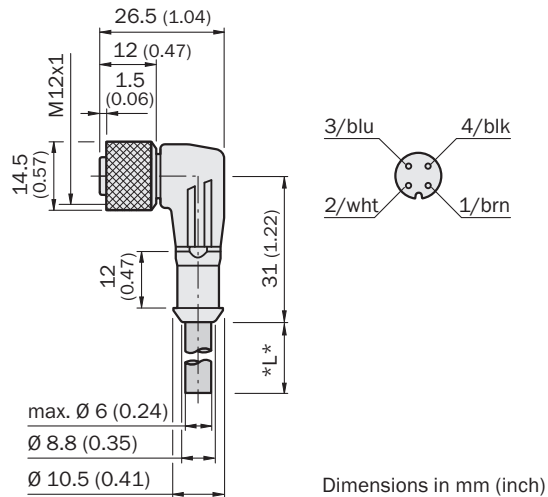

Female connector M8, 4-pin, straight

Cable diameter 5 mm, 4 x 0.25 mm², sheath PVC

Model name	Part No.	Cable length
DOL-0804-G02M	6009870	2 m
DOL-0804-G05M	6009872	5 m

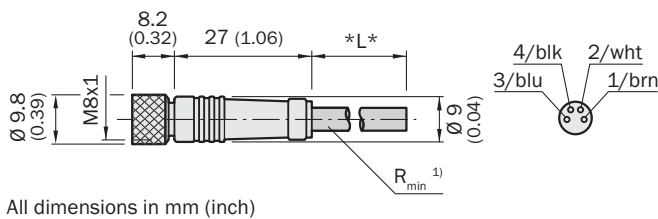

Female connector M8, 4-pin, right angle

Cable diameter 5 mm, 4 x 0.25 mm², sheath PVC

Model name	Part No.	Cable length
DOL-0804-W02M	6009871	2 m
DOL-0804-W05M	6009873	5 m

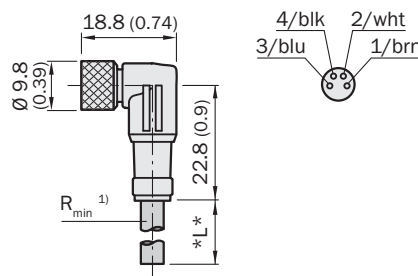

¹⁾ Minimum bend radius in dynamic use
 $R_{min} = 20 \times \text{cable diameter}$

²⁾ Not suitable for sender in through-beam photoelectric sensors

Dimensional drawings and ordering information

SENSICK screw-in system M12, 4-pin, enclosure rating IP 67

Female connector M12, 4-pin, straight

Cable diameter 5 mm, 4 x 0.25 mm², sheath PVC

Model name	Part No.	Contacts	Can be self-made for cables Ø 4.5 to 6.5 mm
DOS-1204-G	6007302	4	

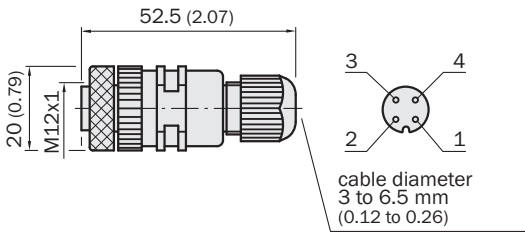

Dimensions in mm (inch)

Female connector M12, 4-pin, right angle

Cable diameter 5 mm, 4 x 0.25 mm², sheath PVC

Model name	Part No.	Contacts	Can be self-made for cables Ø 4.5 to 6.5 mm
DOS-1204-W	6007303	4	

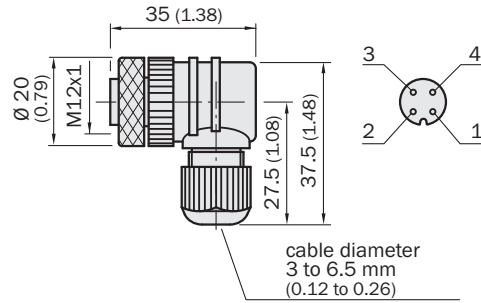

Dimensions in mm (inch)

Female connector M8, 4-pin, straight

Model name	Part No.
DOS-0804-G	6009974

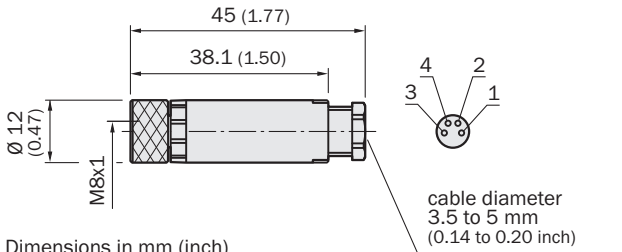

Dimensions in mm (inch)

Female connector M8, 4-pin, right angle

Model name	Part No.
DOS-0804-W	6009975

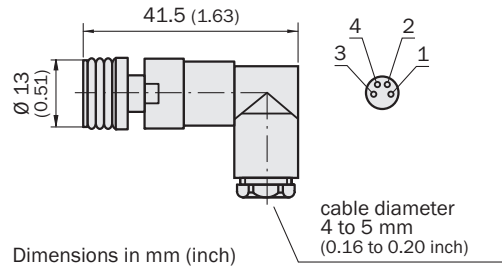

Dimensions in mm (inch)

Dimensional drawings and ordering information

Universal bar clamp systems

Plate N08(N) for universal bar clamp

Model name	Part No.
BEF-KHS-N08 ¹⁾	2051607

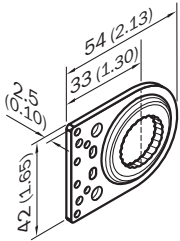

¹⁾ Plate: Steel, galvanized;
Clamp: Die-cast zinc

All dimensions in mm (inch)

Universal bar clamp

Model name	Part No.
BEF-KHS-KH3 ¹⁾	5322626

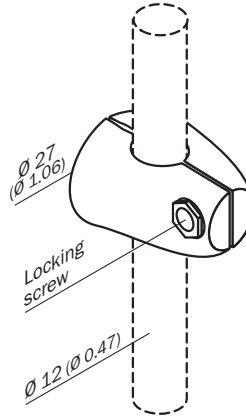

All dimensions in mm (inch)

¹⁾ Die-cast zinc

Mounting rod straight

Model name	Part No.	Size A
BEF-MS12G-A ¹⁾	4056054	200 mm

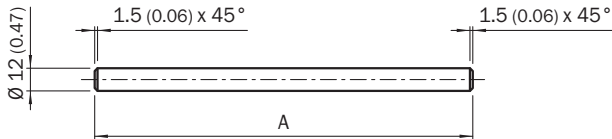

All dimensions in mm (inch)

¹⁾ Steel, galvanized

Mounting rod L-shape

Model name	Part No.	Size A	Size B
BEF-MS12L-B ¹⁾	4056053	250 mm	250 mm

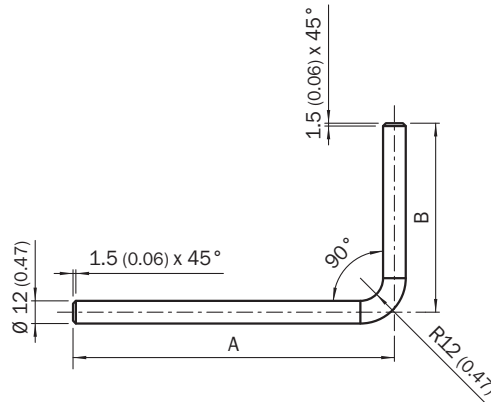

All dimensions in mm (inch)

¹⁾ Steel, galvanized

Mounting rod Z-shape

Model name	Part No.	Size A	Size B	Size C
BEF-MS12Z-A ¹⁾	4056056	150 mm	70 mm	150 mm

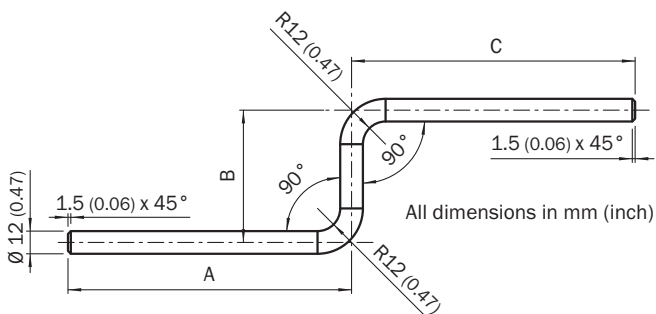

All dimensions in mm (inch)

¹⁾ Steel, galvanized

Dimensional drawings and ordering information

Universal bar clamp systems

Rod mounting clamp

Model name	Part No.	Material
BEF-RMC-D12	5321878	Aluminium

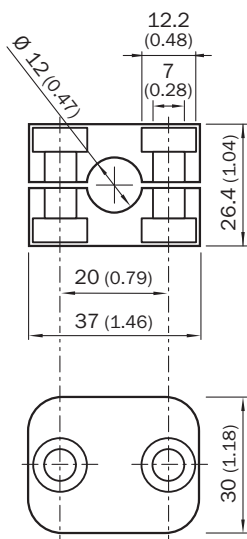

All dimensions in mm (inch)

Mounting bracket

Model name	Part No.	Material
BEF-WN-W9-2	2022855	Steel, galvanised

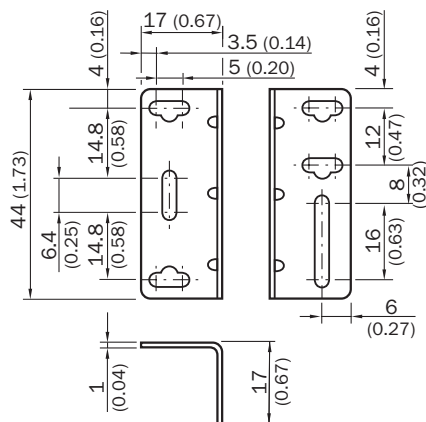

All dimensions in mm (inch)

Fastening plate with threaded sleeve M3

Model name	Part no.	Material
BEF-GPM3-W9	4066039	Plastic (PMMA), Threaded sleeve: Brass

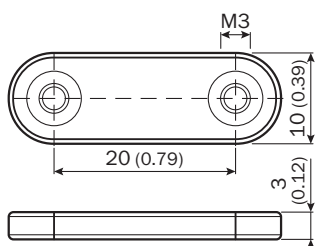

All dimensions in mm (inch)

Dimensional drawings and ordering information

Plastic design for temperatures up to 65 °C

Reflector, 20 x 40 mm

Model name	Part No.
PL20A	1012719

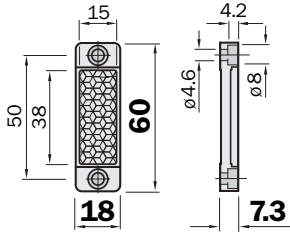

Reflector, 30 x 50 mm

Model name	Part No.
PL30A	1002314

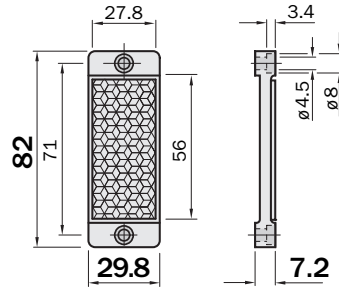

Reflector, 40 x 60 mm

Model name	Part No.
PL40A	1012720

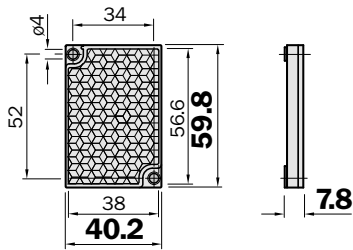

Reflector, 47 x 47 mm²

Model name	Part No.
P250	5304812

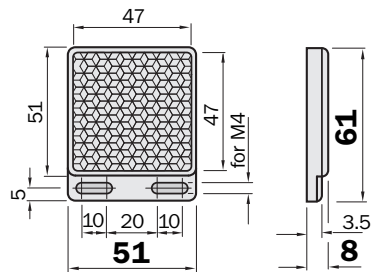

Reflector, 80 x 80 mm

Model name	Part No.
PL80A	1003865

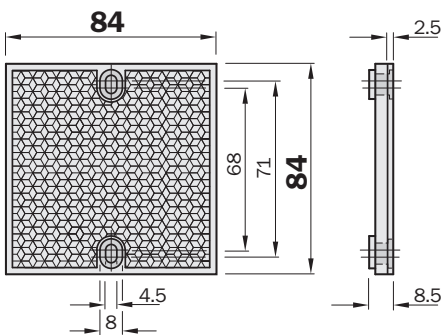

Reflector Ø 83 mm, center hole mounting

Model name	Part No.
C110	5304549

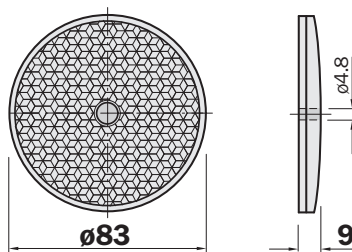

Reflective tape, self-adhesive

Model name	Part No.	Width	
REF-PLUS-R25	5319929	25 mm	Length of roll 22,8 m
REF-PLUS-R50	5319981	50 mm	Length of roll 22,8 m
REF-IRF-56	5314244	50 mm	Length 60 mm

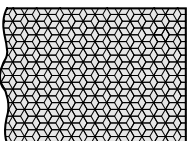

Dimensional drawings and ordering information

Slotted mask card

Slotted mask card for WS/WE9-3

Slot width X: 0.5 mm/1.0 mm/1.5 mm/2.0 mm

Model name	Part No.
BL-9-2	4033253

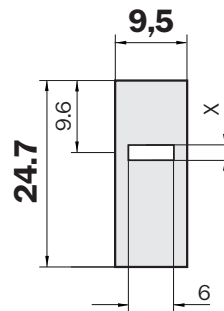
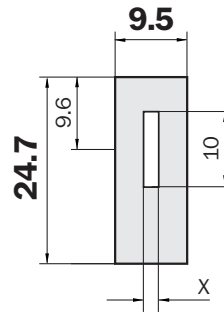
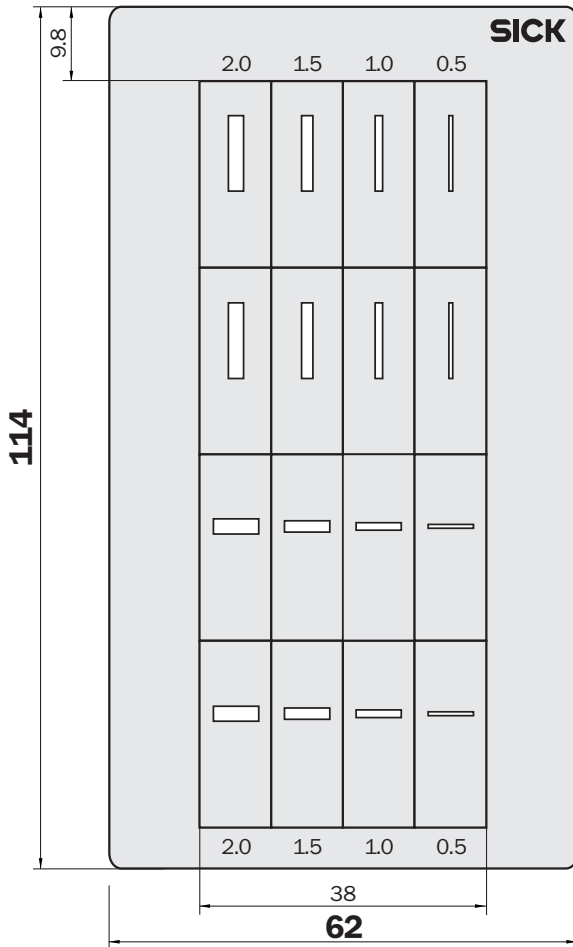

Worldwide presence with subsidiaries in the following countries:

- Australia
- Belgium/Luxembourg
- Brasil
- Ceská Republika
- China
- Danmark
- Deutschland
- España
- France
- Great Britain
- India
- Israel
- Italia
- Japan
- Nederland
- Norge

- Österreich
- Polska
- Republic of Korea
- Republika Slovenija
- România
- Russia
- Schweiz
- Singapore
- Suomi
- Sverige
- Taiwan
- Türkiye
- United Arab Emirates
- USA/Canada/México

Please find detailed addresses and additional representatives and agencies in all major industrial nations at www.sick.com

Handed over by:

Our Business Segment Expertise

Factory automation

With its intelligent sensors, safety systems, and automatic identification applications, SICK provides comprehensive solutions for factory automation.



- Non-contact detecting, counting, classifying, and positioning of any type of object
- Accident protection and personal safety using sensors, as well as safety software and services

Logistics automation

Sensors made by SICK form the basis for automating material flows and the optimization of sorting and warehousing processes.



- Automated identification with barcode and RFID reading devices for the purpose of sorting and target control in industrial material flow
- Detecting volume, position, and contours of objects and surroundings with laser measurement systems

Process automation

Optimized system solutions from SICK ensure efficient acquisition of environmental and process data in many industrial processes.



- Precise measurement of gases, liquids and dust concentrations for continuous monitoring of emissions and the acquisition of process data in production processes
- Gas flow measurements with maximum accuracy thanks to compact gas meters