

SNAP Digital Input Modules

Features

- Four channels per module
- 4,000-volt transient isolation
- Convenient pluggable wiring terminals
- Channel-specific LEDs
- UL and CE approved
- Accepts 22 to 14 AWG wire
- Factory Mutual approved (part numbers ending in FM)

Description

Opto 22 SNAP I/O digital input modules are part of the SNAP PAC System. Optical isolation on these modules provides 4,000 volts of transient (4000 V for 1 ms) protection for sensitive control electronics from industrial field signals. Digital input modules can sense either AC or DC signals.

All SNAP digital modules have removable top-mounted connectors to provide easy access for field wiring, and all operate on 5 VDC control logic. Each digital module features integral channel-specific LEDs for convenient troubleshooting and maintenance. Each module is factory tested twice and is UL and CE approved. In addition, part numbers ending in FM are Factory Mutual approved.

SNAP input modules are used to sense the on or off status for AC or DC voltages from such sources as proximity switches, push buttons, or auxiliary contacts. The SNAP-IDC5G is ideal for detecting 48 VDC in telecom applications. The SNAP-IDC5-HT is designed for sensors that have a high leakage current.

The SNAP-IDC5-SW and SNAP-IDC5-SW-NC modules supply power to an external dry contact switch and sense switch closure (SNAP-IDC5-SW) or opening (SNAP-IDC5-SW-NC).

SNAP-IAC5MA and SNAP-IDC5MA feature manual-on/manual-off/automatic switches, ideal for testing control applications. The switches override input



SNAP Digital Input Modules

from field devices, so you can determine whether a problem lies in the application or in the device.

SNAP racks use a retention rail locking system that holds modules securely to the rack. Normally, a hold-down screw is not required. However, for applications that require additional module security, each module has provisions for two 4-40 by 1/2-inch standard machine screws to hold the module in position on the SNAP rack.

Part Numbers

Part	Description
SNAP-IAC5	SNAP 4-channel 90–140 VAC input, 5 VDC logic
SNAP-IAC5A	SNAP 4-channel 180–280 VAC input, 5 VDC logic
SNAP-IAC5MA	SNAP 4-channel isolated 90–140 VAC/VDC input, 5 VDC logic, with manual/auto switches
SNAP-IAC5FM	SNAP 4-channel 90–140 VAC/VDC input, 5 VDC logic, Factory Mutual approved
SNAP-IAC5AFM	SNAP 4-channel 180–280 VAC input, 5 VDC logic, Factory Mutual approved
SNAP-IDC5	SNAP 4-channel 10–32 VDC input, 5 VDC logic
SNAP-IDC5D	SNAP 4-channel 2.5–28 VDC input, 5 VDC logic
SNAP-IDC5FAST	SNAP 4-channel high-speed 2.5–16 VDC input, 5 VDC logic
SNAP-IDC5-FAST-A	SNAP 4-channel high-speed 18–32 VDC input, 5 VDC logic
SNAP-IDC5G	SNAP 4-channel 35–75 VAC/DC input, 5 VDC logic
SNAP-IDC5AF	SNAP 4-channel high-speed 75–140 VDC input, 5 VDC logic
SNAP-IDC5GF	SNAP 4-channel high-speed 35–75 VDC input, 5 VDC logic
SNAP-IDC5-HT	SNAP 4-channel 15–32 VDC leakage-tolerant input, 5 VDC logic
SNAP-IDC5MA	SNAP 4-channel isolated high-speed 10–32 VAC/VDC input, 5 VDC logic, with manual/auto switches
SNAP-IDC5-SW	SNAP 4-channel switch status input, normally open
SNAP-IDC5-SW-NC	SNAP 4-channel switch status input, normally closed
SNAP-IDC5FM	SNAP 4-channel 10–32 VDC input, 5 VDC logic, Factory Mutual approved
SNAP-IDC5DFM	SNAP 4-channel 2.5–28 VDC input, 5 VDC logic
SNAP-RETN4	SNAP 4-module retention rail (OEM)
SNAP-RETN4B	SNAP 4-module retention rail, 25-pack (OEM)
SNAP-RETN6	SNAP 6-module retention rail (OEM)
SNAP-RETN6B	SNAP 6-module retention rail, 25-pack (OEM)
SNAP-FUSE4AB	SNAP 4-amp fuse, 25-pac

SNAP digital input modules are compatible with all SNAP PAC brains and rack-mounted controllers, including Wired+Wireless™.

Notes for legacy hardware: These modules can also be used with SNAP Ultimate, SNAP Ethernet, and SNAP Simple brains, and with other SNAP brains such as the serial B3000 and the B3000HA. They also mount on B-series, M-series, and D-series racks.

SNAP Digital Input Modules

Wiring Options

For easier, faster wiring of field devices to input modules, see the *SNAP TEX Cables and Breakout Boards Data Sheet*, form #1756. Each SNAP TEX cable snaps into the top of the module and terminates at the breakout board with 18-gauge, color-coded flying leads, already stripped and ready for wiring. Breakout boards offer optional fusing, fuse-blown indicators, and bussed power to loads.

Specifications: AC Input Modules

	SNAP-IAC5	SNAP-IAC5A	SNAP-IAC5MA
Key Feature	--	--	Diagnostic switches
Wire size	22 to 14 AWG	22 to 14 AWG	22 to 14 AWG
Torque, hold-down screws	4 in-lb (0.45 N-m)	4 in-lb (0.45 N-m)	4 in-lb (0.45 N-m)
Torque, connector screws	5.26 in-lb (0.6 N-m)	5.26 in-lb (0.6 N-m)	5.26 in-lb (0.6 N-m)
Field Side Ratings (each channel)			
Nominal Input Voltage	120 VAC/VDC	240 VAC/VDC	120 VAC/VDC
Channel-to-channel isolation	300 VAC (1,500 V transient)	300 VAC (1,500 V transient)	300 VAC (1,500 V transient)
Input Voltage Range	90–140 VAC/VDC	180–280 VAC/VDC	90–140 VAC/VDC
Turn-on Voltage	90 VAC/VDC	180 VAC/VDC	90 VAC/VDC
Turn-off Voltage	35 VAC/VDC	35 VAC/VDC	35 VAC/VDC
Input Resistance	169 K ohms (nominal)	305 K ohms (nominal)	169 K ohms (nominal)
Logic Side Ratings			
Logic Output Voltage	<.5 V max. (on) @ 2 mA sinking 2.7 V min. (off) @ 400 mA sourcing	<.5 V max. (on) @ 2 mA sinking 2.7 V min. (off) @ 400 mA sourcing	<.5 V max. (on) @ 2 mA sinking 2.7 V min. (off) @ 400 mA sourcing
Logic Supply Voltage*	5 VDC ± 0.25 VDC	5 VDC ± 0.25 VDC	5 VDC ± 0.25 VDC
Logic Supply Current	50 mA maximum	50 mA maximum	50 mA maximum
Negative True Logic Output Drive	TTL 74 Series = 1 UL TTL 74LS Series = 5 UL	TTL 74 Series = 1 UL TTL 74LS Series = 5 UL	TTL 74 Series = 1 UL TTL 74LS Series = 5 UL
Module Ratings			
Number of Channels Per Module	4	4	4
Turn-on Time	30 msec	30 msec	30 msec
Turn-off Time	30 msec	30 msec	30 msec
Optical Isolation, Field to Logic	4,000 volts (transient)	4,000 volts (transient)	4,000 volts (transient)
Temperature	-20 °C to 70 °C, operating -40 °C to 85 °C, storage	-20 °C to 70 °C, operating -40 °C to 85 °C, storage	-20 °C to 70 °C, operating -40 °C to 85 °C, storage
Agency Approvals	UL, CE, CSA, RoHS, DFARS	UL, CE, CSA, RoHS, DFARS	UL, CE, RoHS, DFARS
Warranty	Lifetime	Lifetime	30 months

* When used with an I/O processor (brain or on-the-rack controller), the processor requires 5.0 to 5.2 VDC.

SNAP Digital Input Modules

Specifications: DC Input Modules

See [page 7](#) for SNAP-IDC5-SW and SNAP-IDC5-SW-NC specifications and wiring.

	SNAP-IDC5	SNAP-IDC5D	SNAP-IDC5G	SNAP-IDC5-HT
Key Feature	--	--	--	Leakage-tolerant
Wire size	22 to 14 AWG	22 to 14 AWG	22 to 14 AWG	22 to 14 AWG
Torque, hold-down screws	4 in-lb (0.45 N-m)	4 in-lb (0.45 N-m)	4 in-lb (0.45 N-m)	4 in-lb (0.45 N-m)
Torque, connector screws	5.26 in-lb (0.6 N-m)	5.26 in-lb (0.6 N-m)	5.26 in-lb (0.6 N-m)	5.26 in-lb (0.6 N-m)
Field Side Ratings (each channel)				
Nominal Input Voltage	24 VAC/VDC	5 VDC	48 VAC/VDC	24 VAC/VDC
Channel-to-channel isolation	300 VAC (1,500 V transient)	300 VAC (1,500 V transient)	300 VAC (1,500 V transient)	300 VAC (1,500 V transient)
Input Voltage Range	10–32 VAC/VDC	2.5–28 VDC	35–75 VAC/VDC	15–32 VAC/VDC
Turn-on Voltage	10 VAC/VDC	2.5 VDC	35 VAC/VDC	15 VAC/VDC
Turn-off Voltage	3 VAC/VDC	1 VDC	7 VAC/VDC	8 VAC/VDC
Input Resistance	15 K ohms (nominal)	3 K ohms (nominal)	64 K ohms (nominal)	3 K ohms (nominal)
Logic Side Ratings				
Logic Output Voltage	<.5 V max. (on) @ 2 mA sinking 2.7 V min. (off) @ 0.4 mA sourcing	<.5 V max. (on) @ 2 mA sinking 2.7 V min. (off) @ 0.4 mA sourcing	<.5 V max. (on) @ 2 mA sinking 2.7 V min. (off) @ 0.4 mA sourcing	<.5 V max. (on) @ 2 mA sinking 2.7 V min. (off) @ 0.4 mA sourcing
Logic Supply Voltage***	5 VDC ± 0.25 VDC	5 VDC ± 0.25 VDC	5 VDC ± 0.25 VDC	5 VDC ± 0.25 VDC
Logic Supply Current	50 mA maximum	50 mA maximum	50 mA maximum	50 mA maximum
Negative True Logic Output Drive	TTL 74 Series = 1 UL TTL 74LS Series = 5 UL	TTL 74 Series = 1 UL TTL 74LS Series = 5 UL	TTL 74 Series = 1 UL TTL 74LS Series = 5 UL	TTL 74 Series = 1 UL TTL 74LS Series = 5 UL
Module Ratings				
Number of Channels Per Module	4	4	4	4
Turn-on Time	5 msec	1 msec	5 msec	20 msec
Turn-off Time	15 msec	1 msec	15 msec	25 msec
Optical Isolation (Field Side to Logic Side)	4,000 volts (transient)	4,000 volts (transient)	4,000 volts (transient)	4,000 volts (transient)
Temperature	-20 to 70 °C, operating -40 to 85 °C, storage	-20 to 70 °C, operating -40 to 85 °C, storage	-20 to 70 °C, operating -40 to 85 °C, storage	-20 to 70 °C, operating -40 to 85 °C, storage
Agency Approvals	UL, CE, CSA, RoHS, DFARS	UL, CE, CSA, RoHS, DFARS	UL, CE, RoHS, DFARS	CE, RoHS, DFARS
Warranty	Lifetime	Lifetime	Lifetime	Lifetime

* At 20kHz, 5Vp-p square wave input, 50% duty cycle.

** At 20kHz, 28Vp-p square wave input, 50% duty cycle.

*** When used with an I/O processor (brain or on-the-rack controller), the processor requires 5.0 to 5.2 VDC.

SNAP Digital Input Modules

Specifications: DC Input Modules (continued)

See [page 7](#) for SNAP-IDC5-SW and SNAP-IDC5-SW-NC specifications and wiring.

	SNAP-IDC5GF	SNAP-IDC5AF
Key Feature	--	--
Wire size	22 to 14 AWG	22 to 14 AWG
Torque, hold-down screws	4 in-lb (0.45 N-m)	4 in-lb (0.45 N-m)
Torque, connector screws	5.26 in-lb (0.6 N-m)	5.26 in-lb (0.6 N-m)
Field Side Ratings (each channel)		
Nominal Input Voltage	48 VDC	120 VDC
Channel-to-channel isolation	300 VAC (1,500 V transient)	300 VAC (1,500 V transient)
Input Voltage Range	35–75 VDC	75–140 VDC
Turn-on Voltage	35 VDC	75 VDC
Turn-off Voltage	20 VDC	35 VDC
Input Resistance	54 K ohms (nominal)	169 K ohms (nominal)
Logic Side Ratings		
Logic Output Voltage	<0.5 V max. (on) @ 2 mA sinking 2.7 V min. (off) @ 0.4 mA sourcing	<0.5 V max. (on) @ 2 mA sinking 2.7 V min. (off) @ 400 mA sourcing
Logic Supply Voltage*	5 VDC ± 0.25 VDC	5 VDC ± 0.25 VDC
Logic Supply Current	50 mA maximum	50 mA maximum
Negative True Logic Output Drive	TTL 74 Series = 1 UL TTL 74LS Series = 5 UL	TTL 74 Series = 1 UL TTL 74LS Series = 5 UL
Module Ratings		
Number of Channels Per Module	4	4
Turn-on Time	1 msec	1 msec
Turn-off Time	1 msec	1 msec
Optical Isolation (Field Side to Logic Side)	4,000 volts (transient)	4,000 volts (transient)
Temperature	-20 °C to 70 °C, operating -40 °C to 85 °C, storage	-20 °C to 70 °C, operating -40 °C to 85 °C, storage

* When used with an I/O processor (brain or on-the-rack controller), the processor requires 5.0 to 5.2 VDC.

SNAP Digital Input Modules

Specifications: DC Input Modules (continued)

See page 7 for SNAP-IDC5-SW and SNAP-IDC5-SW-NC specifications and wiring.)

	SNAP-IDC5FAST*	SNAP-IDC5-FAST-A**	SNAP-IDC5MA
Key Feature	High-speed	High-speed	Diagnostic switches
Wire size	22 to 14 AWG	22 to 14 AWG	22 to 14 AWG
Torque, hold-down screws	4 in-lb (0.45 N-m)	4 in-lb (0.45 N-m)	4 in-lb (0.45 N-m)
Torque, connector screws	5.26 in-lb (0.6 N-m)	5.26 in-lb (0.6 N-m)	5.26 in-lb (0.6 N-m)
Field Side Ratings (each channel)			
Nominal Input Voltage	5 VDC	28 VDC	24 VAC/VDC
Channel-to-channel isolation	300 VAC (1,500 V transient)	300 VAC (1,500 V transient)	300 VAC (1,500 V transient)
Input Voltage Range	2.5–16 VDC	18–32 VDC	10–32 VAC/VDC
Turn-on Voltage	2.5 VDC	18 VDC	10 VAC/VDC
Turn-off Voltage	1 VDC	5 VDC	3 VAC/VDC
Input Resistance	440 ohms (nominal)	8 K ohms (nominal)	15 K ohms (nominal)
Logic Side Ratings			
Logic Output Voltage	<0.5 V max. (on) @ 2 mA sinking 2.7 V min. (off) @ 0.4 mA sourcing	<0.5 V max. (on) @ 2 mA sinking 2.7 V min. (off) @ 0.4 mA sourcing	<0.5 V max. (on) @ 2 mA sinking 2.7 V min. (off) @ 400 mA sourcing
Logic Supply Voltage***	5 VDC ± 0.25 VDC	5 VDC ± 0.25 VDC	5 VDC ± 0.25 VDC
Logic Supply Current	50 mA maximum	50 mA maximum	50 mA maximum
Negative True Logic Output Drive	TTL 74 Series = 1 UL TTL 74LS Series = 5 UL	TTL 74 Series = 1 UL TTL 74LS Series = 5 UL	TTL 74 Series = 1 UL TTL 74LS Series = 5 UL
Module Ratings			
Number of Channels Per Module	4	4	4
Turn-on Time	0.025 msec*	0.025 msec**	5 msec
Turn-off Time	0.025 msec*	0.025 msec**	15 msec
Optical Isolation (Field Side to Logic Side)	4,000 volts (transient)	4,000 volts (transient)	4,000 volts (transient)
Temperature	-20 °C to 70 °C, operating -40 °C to 85 °C, storage	-20 °C to 70 °C, operating -40 °C to 85 °C, storage	-20 °C to 70 °C, operating -40 °C to 85 °C, storage
Agency Approvals	UL, CE, FM, CSA, RoHS, DFARS	UL, CE, CSA, RoHS, DFARS	CE, RoHS, DFARS
Warranty	Lifetime	Lifetime	30 months

* At 20kHz, 5Vp-p square wave input, 50% duty cycle.

** At 20kHz, 28Vp-p square wave input, 50% duty cycle.

*** When used with an I/O processor (brain or on-the-rack controller), the processor requires 5.0 to 5.2 VDC.

SNAP Digital Input Modules

Specifications: AC and DC Input Modules (FM models)

	SNAP-IAC5FM	SNAP-IAC5AFM	SNAP-IDC5FM	SNAP-IDC5DFM
Key Feature	Factory Mutual approved	Factory Mutual approved	Factory Mutual approved	Factory Mutual approved
Wire size	22 to 14 AWG	22 to 14 AWG	22 to 14 AWG	22 to 14 AWG
Torque, hold-down screws	4 in-lb (0.45 N-m)	4 in-lb (0.45 N-m)	4 in-lb (0.45 N-m)	4 in-lb (0.45 N-m)
Torque, connector screws	5.26 in-lb (0.6 N-m)	5.26 in-lb (0.6 N-m)	5.26 in-lb (0.6 N-m)	5.26 in-lb (0.6 N-m)
Field Side Ratings (each channel)				
Nominal Input Voltage	120 VAC/VDC	240 VAC/ VDC	24 VAC/VDC	5 VDC
Channel-to-channel isolation	300 VAC (1,500 V transient)	300 VAC (1,500 V transient)	300 VAC (1,500 V transient)	300 VAC (1,500 V transient)
Input Voltage Range	90–140 VAC/VDC	180–280 VAC/VDC	10–32 VAC/VDC	2.5–28 VDC
Turn-on Voltage	90 VAC/VDC	180 VAC/VDC	10 VAC/VDC	2.5 VDC
Turn-off Voltage	35 VAC/VDC	35 VAC/VDC	3 VAC/VDC	1 VDC
Input Resistance	169 K ohms (nominal)	305 K ohms (nominal)	15 K ohms (nominal)	3 K ohms (nominal)
Logic Side Ratings				
Logic Output Voltage	<.5 V max. (on) @ 2 mA sinking 2.7 V min. (off) @ 400 mA sourcing	<.5 V max. (on) @ 2 mA sinking 2.7 V min. (off) @ 400 mA sourcing	<.5 V max. (on) @ 2 mA sinking 2.7 V min. (off) @ 0.4 mA sourcing	<.5 V max. (on) @ 2 mA sinking 2.7 V min. (off) @ 0.4 mA sourcing
Logic Supply Voltage*	5 VDC ± 0.25 VDC	5 VDC ± 0.25 VDC	5 VDC ± 0.25 VDC	5 VDC ± 0.25 VDC
Logic Supply Current	50 mA maximum	50 mA maximum	50 mA maximum	50 mA maximum
Negative True Logic Output Drive	TTL 74 Series=1 UL TTL 74LS Series=5 UL	TTL 74 Series=1 UL TTL 74LS Series=5 UL	TTL 74 Series=1 UL TTL 74LS Series=5 UL	TTL 74 Series=1 UL TTL 74LS Series=5 UL
Module Ratings				
Number of Channels Per Module	4	4	4	4
Turn-on Time	30 msec	30 msec	5 msec	1 msec
Turn-off Time	30 msec	30 msec	15 msec	1 msec
Optical Isolation (Field Side to Logic Side)	4,000 volts (transient)	4,000 volts (transient)	4,000 volts (transient)	4,000 volts (transient)
Temperature	-20 to 70 °C, operating -40 to 85 °C, storage	-20 to 70 °C, operating -40 to 85 °C, storage	-20 to 70 °C, operating -40 to 85 °C, storage	-20 to 70 °C, operating -40 to 85 °C, storage
Agency Approvals	CE, FM, RoHS, DFARS	CE, FM, RoHS, DFARS	CE, FM, RoHS, DFARS	CE, FM, RoHS, DFARS
Warranty	Lifetime	Lifetime	Lifetime	Lifetime

*When used with an I/O processor (brain or on-the-rack controller), the processor requires 5.0 to 5.2 VDC.

SNAP Digital Input Modules

SNAP-IDC5-SW and SNAP-IDC5-SW-NC Modules

Description

The SNAP-IDC5-SW and SNAP-IDC5-SW-NC modules provide four channels of contact status input. Each module supplies 15 volts of power to an external dry contact switch. The SNAP-IDC5-SW senses switch closure; the SNAP-IDC5-SW-NC senses switch opening. Each user-supplied switch is connected with two wires. Because these modules include power for the switch, they are particularly cost-effective when labor costs for wiring external power are high.

Typical switches for use with these modules are switched status sensors (level sensors, pressure indicators, etc.), magnetic reed switches (used on doors or windows for burglar alarms), snap-action micro switches, the auxiliary switches on motor starters, and most relay contacts.

CAUTION: The SNAP-IDC5-SW and SNAP-IDC5-SW-NC inputs are not intended to be used with contacts that are connected to any external user-supplied voltage or currents.

SNAP-IDC5-SW and SNAP-IDC5-SW-NC Wiring Diagram

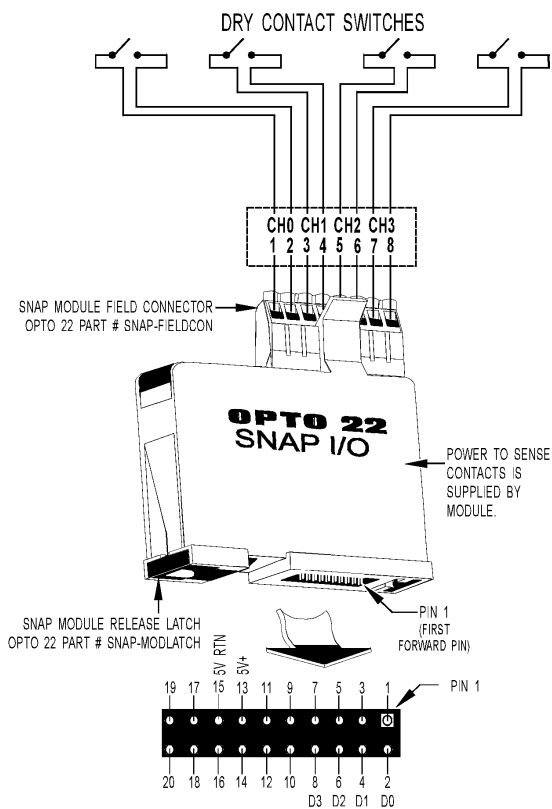

SNAP DIGITAL MODULE BASE CONTROL CONNECTOR (BOTTOM VIEW)

Specifications

Field Side Ratings (each channel)	
Open Circuit Voltage (Switch Open)	15 VDC typical
Short Circuit Current (Switch Closed)	7 milliamps nominal
Minimum Off Resistance	>20 K ohms
Maximum Allowable On Resistance (Wire + Contact Resistance)	500 ohms
Logic Side Ratings	
Logic Output Voltage for SNAP-IDC5-SW (normally open)	<0.5 V max. (switch closed; LED on) @ 2 mA sinking 2.7 V min. (switch open; LED off) @ 0.4 mA sourcing
Logic Output Voltage for SNAP-IDC5-SW-NC (normally closed)	<0.5 V max. (switch closed; LED off) @ 2 mA sinking 2.7 V min. (switch open; LED on) @ 0.4 mA sourcing
Maximum Operating Common Mode Voltage (Field Term to Logic Connector)	250 V
Power Requirements	5 VDC (±0.25) @ 200 mA
Module Ratings	
Number of Channels Per Module	4
Turn-on Time	5 msec
Turn-off Time	25 msec
Channel-to-channel Isolation	None
Input-to-output Isolation	1500 V AC/DC
Wire size	22 to 14 AWG
Torque, hold-down screws	4 in-lb (0.45 N-m)
Torque, connector screws	5.26 in-lb (0.6 N-m)
Temperature	-20 °C to 70 °C, operating -40 °C to 85 °C, storage
Agency Approvals	UL, CE, RoHS, DFARS FM (SNAP-IDC5SW only)
Warranty	Lifetime

SNAP Digital Input Modules

Schematics

Most AC and DC Input Modules

See previous page for SNAP-IDC5-SW and SNAP-IDC5-SW-NC wiring diagram.

MA Modules with Manual/Auto Switches (Top View)

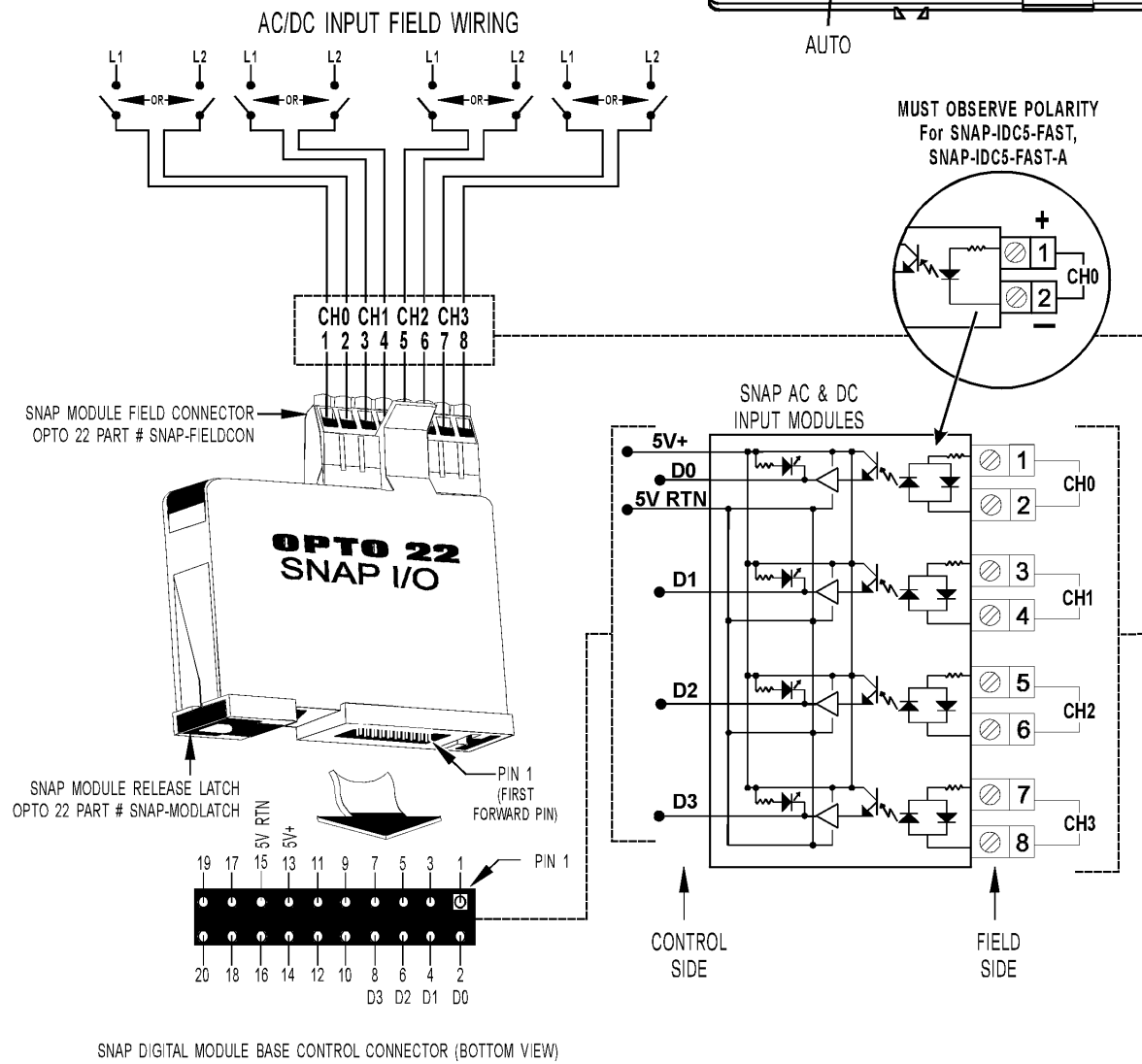
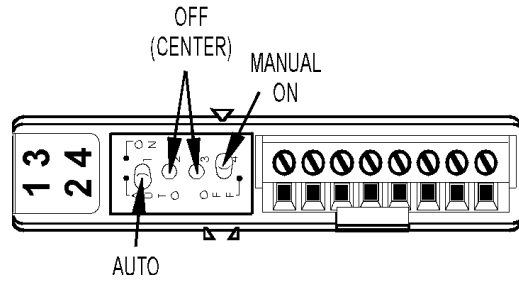

SNAP MODULE FIELD CONNECTOR
OPTO 22 PART # SNAP-FIELDCON

OPTO 22
SNAP I/O

SNAP MODULE RELEASE LATCH
OPTO 22 PART # SNAP-MODLATCH

PIN 1
(FIRST FORWARD PIN)

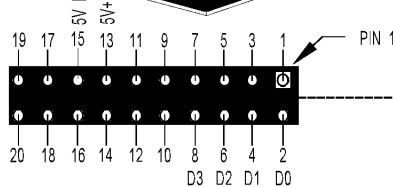

SNAP DIGITAL MODULE BASE CONTROL CONNECTOR (BOTTOM VIEW)

SNAP Digital Input Modules

Dimensional Drawing

All Modules Except MA

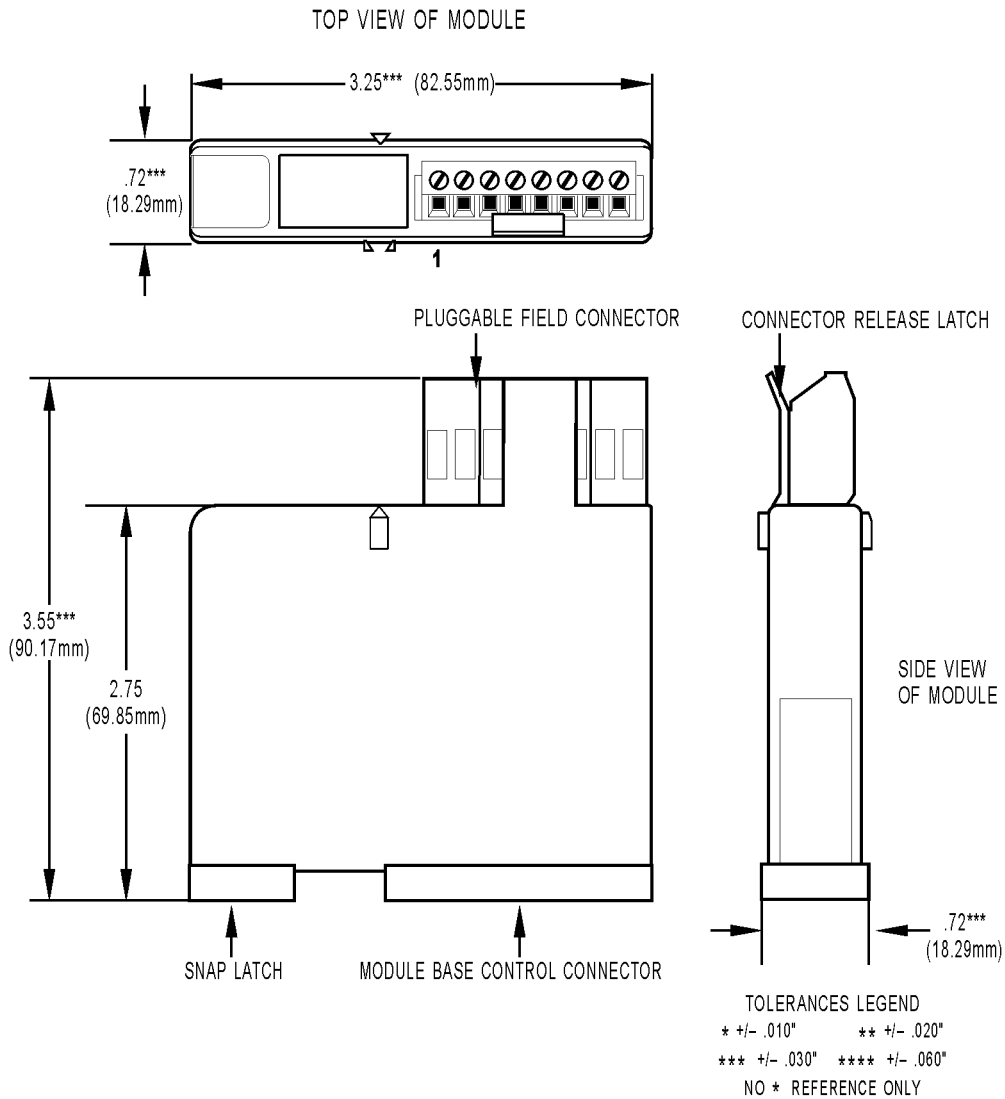

SNAP Digital Input Modules

Dimensional Drawing

All MA Modules

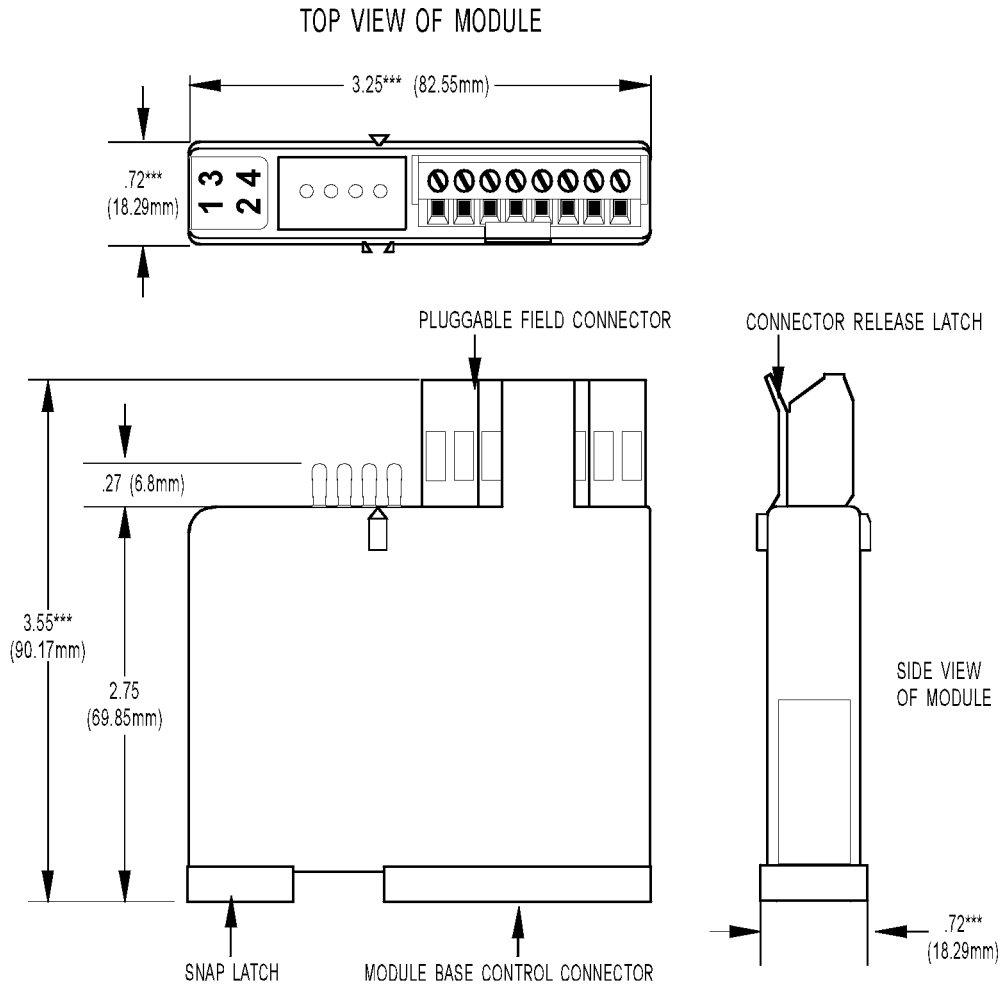

TOLERANCES LEGEND

- * +/- .010"
- ** +/- .020"
- *** +/- .030"
- **** +/- .060"
- NO * REFERENCE ONLY

SNAP Digital Input Modules

Dimensional Drawing

All Models

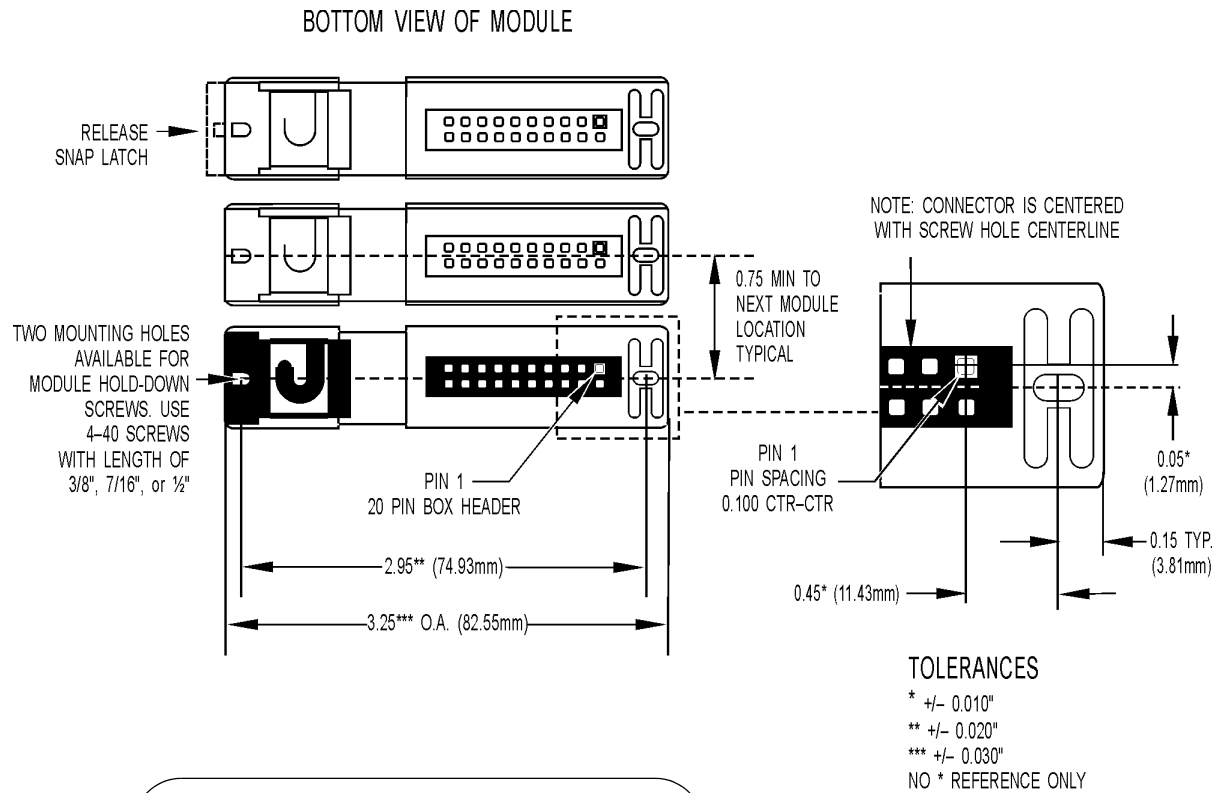

IMPORTANT: The mounting rack connector has 24 pins; the module connector has 20 pins. The extra pins on the mounting rack connector prevent misalignment of the module during installation.

SNAP Digital Input Modules

Dimensional Drawing

All Models

SNAP Digital Module Mounted on SNAP Rack

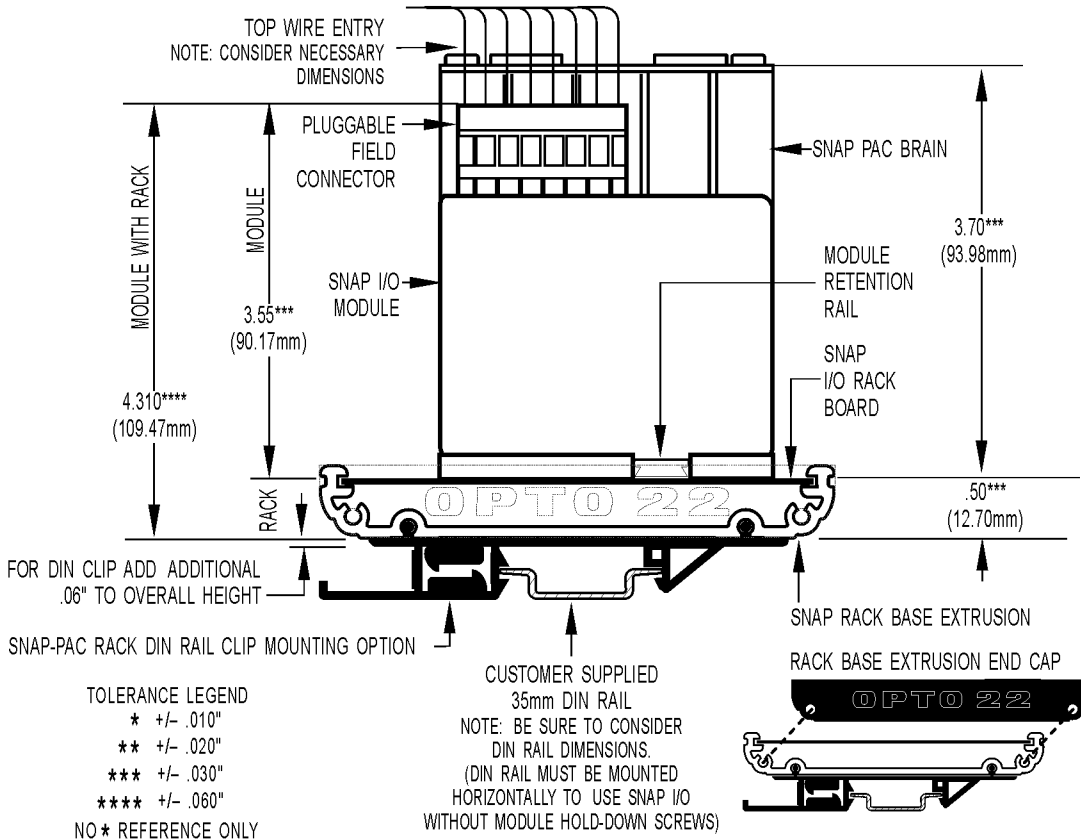

More About Opto 22

Products

Opto 22 develops and manufactures reliable, flexible, easy-to-use hardware and software products for industrial automation, energy management, remote monitoring, and data acquisition applications.

groov

groov puts your system on your mobile device. With zero programming, you can build mobile operator interfaces to monitor and control systems from Allen-Bradley, Siemens, Schneider Electric, Modicon, and many more. Web-based groov puts mobile-ready gadgets at your fingertips. Tag them from your existing tag database, and they automatically scale for use on any device with a modern web browser. See groov.com for more information and your free trial.

SNAP PAC System

Designed to simplify the typically complex process of selecting and applying an automation system, the SNAP PAC System consists of four integrated components:

- SNAP PAC controllers
- PAC Project™ Software Suite
- SNAP PAC brains
- SNAP I/O™

SNAP PAC Controllers

Programmable automation controllers (PACs) are multifunctional, modular controllers based on open standards.

Opto 22 has been manufacturing PACs for over two decades. The standalone SNAP PAC S-series, the rack-mounted SNAP PAC R-series, and the software-based SoftPAC™ all handle a wide range of digital, analog, and serial functions for data collection, remote monitoring, process control, and discrete and hybrid manufacturing.

SNAP PACs are based on open Ethernet and Internet Protocol (IP) standards, so you can build or extend a system easily, without the expense and limitations of proprietary networks and protocols. Wired+Wireless™ models are also available.

PAC Project Software Suite

Opto 22's PAC Project Software Suite provides full-featured, cost-effective control programming, HMI (human machine interface) development and runtime, OPC server, and database connectivity software for your SNAP PAC System.

Control programming includes both easy-to-learn flowcharts and optional scripting. Commands are in plain English; variables and I/O point names are fully descriptive.

PAC Project Basic offers control and HMI tools and is free for download on our website, www.opto22.com. PAC Project

Professional, available for separate purchase, adds one SoftPAC, OptoOPCServer, OptoDataLink, options for controller redundancy or segmented networking, and support for legacy Opto 22 serial *mistic*™ I/O units.

SNAP PAC Brains

While SNAP PAC controllers provide central control and data distribution, SNAP PAC brains provide distributed intelligence for I/O processing and communications. Brains offer analog, digital, and serial functions, including thermocouple linearization; PID loop control; and optional high-speed digital counting (up to 20 kHz), quadrature counting, TPO, and pulse generation and measurement.

SNAP I/O

I/O provides the local connection to sensors and equipment. Opto 22 SNAP I/O offers 1 to 32 points of reliable I/O per module, depending on the type of module and your needs. Analog, digital, and serial modules are all mixed on the same mounting rack and controlled by the same processor (SNAP PAC brain or rack-mounted controller).

Quality

Founded in 1974, Opto 22 has established a worldwide reputation for high-quality products. All are made in the U.S.A. at our manufacturing facility in Temecula, California. Because we test each product twice before it leaves our factory, rather than only testing a sample of each batch, we can guarantee most solid-state relays and optically isolated I/O modules for life.

Free Product Support

Opto 22's California-based Product Support Group offers free, comprehensive technical support for Opto 22 products. Our staff of support engineers represents decades of training and experience. Support is available in English and Spanish by phone or email, Monday–Friday, 7 a.m. to 5 p.m. PST.

Additional support is always available on our website: how-to videos, OptoKnowledgeBase, self-training guide, troubleshooting and user's guides, and OptoForums.

In addition, hands-on training is available for free at our Temecula, California headquarters, and you can [register online](#).

Purchasing Opto 22 Products

Opto 22 products are sold directly and through a worldwide network of distributors, partners, and system integrators. For more information, contact Opto 22 headquarters at 800-321-6786 or 951-695-3000, or visit our website at www.opto22.com.



www.opto22.com