

P10

workshop tool trolley
with 299 tools for 5 drawers
810.5299

Workshop trolley P10

with 8 compartments

873.0008

THE ENTRY MODEL TO SATISFY HIGH STANDARDS



P10



DUO Lock Brilliant locking system



Eight drawers each load capacity up to 50 kg



Stable **ball bearing**



Stainless steel surface

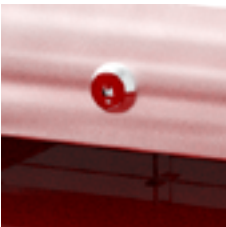

Lock lockable



Anti-static castors with brakes



Integrated **corner protection**



Paper roll holder included



Can holder included

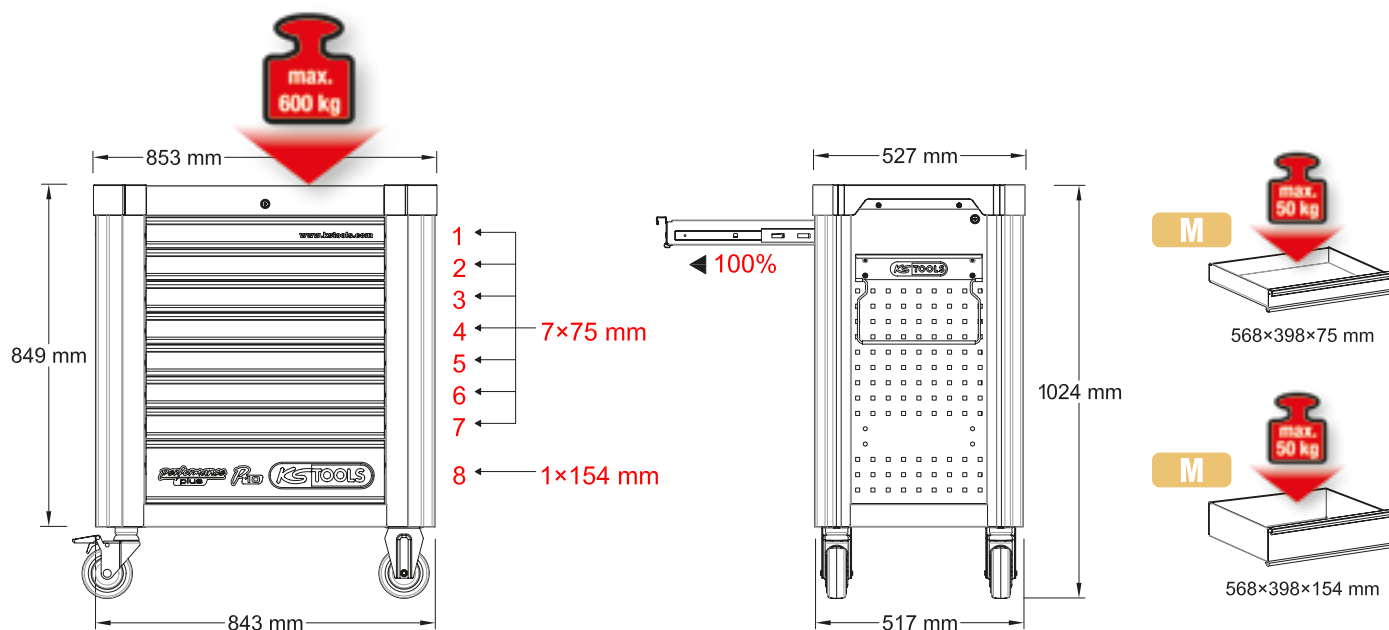

P10 workshop tool trolley set with 299 tools for 5 drawers

810.5299



M

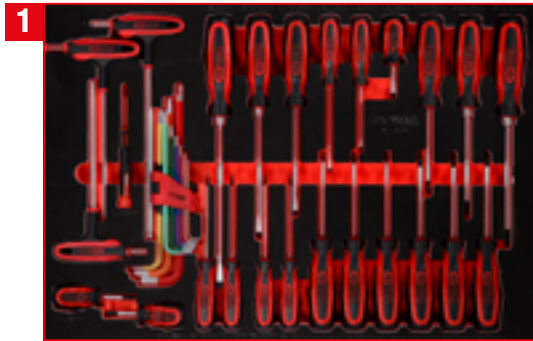

Screwdriver set in foam insert

811.0034

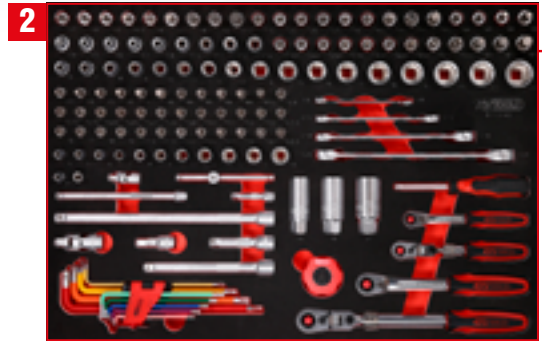

1/4" + 3/8" socket spanner set in foam insert

811.0140



1/2" screwdriver bit set in foam insert

811.0064



Screw spanner set in foam insert

811.0038



Pliers, hammer and chisel set in foam insert

811.1023

811.0034

M Screwdriver set

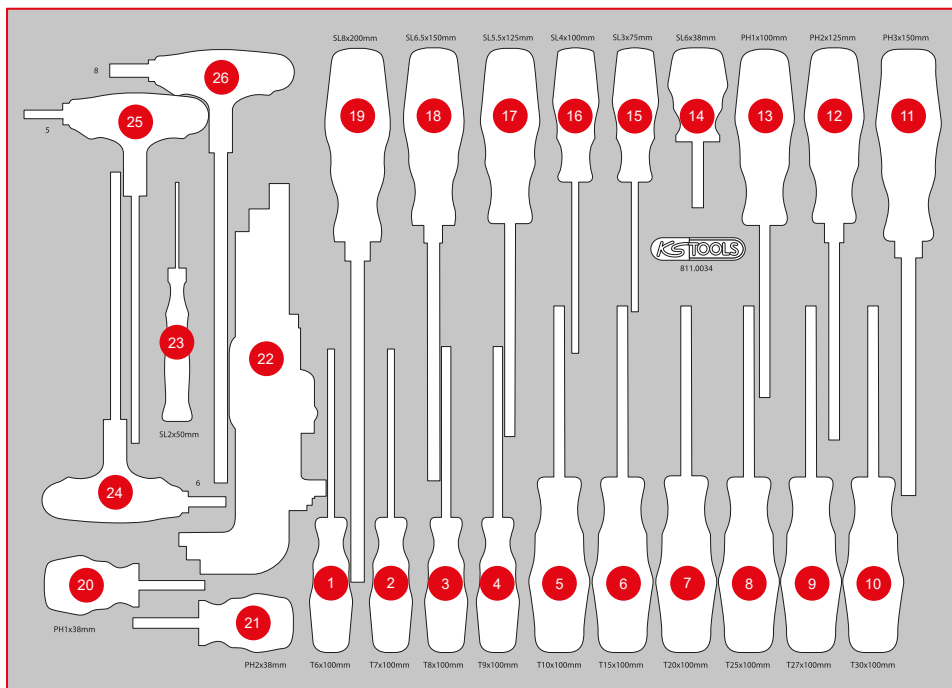
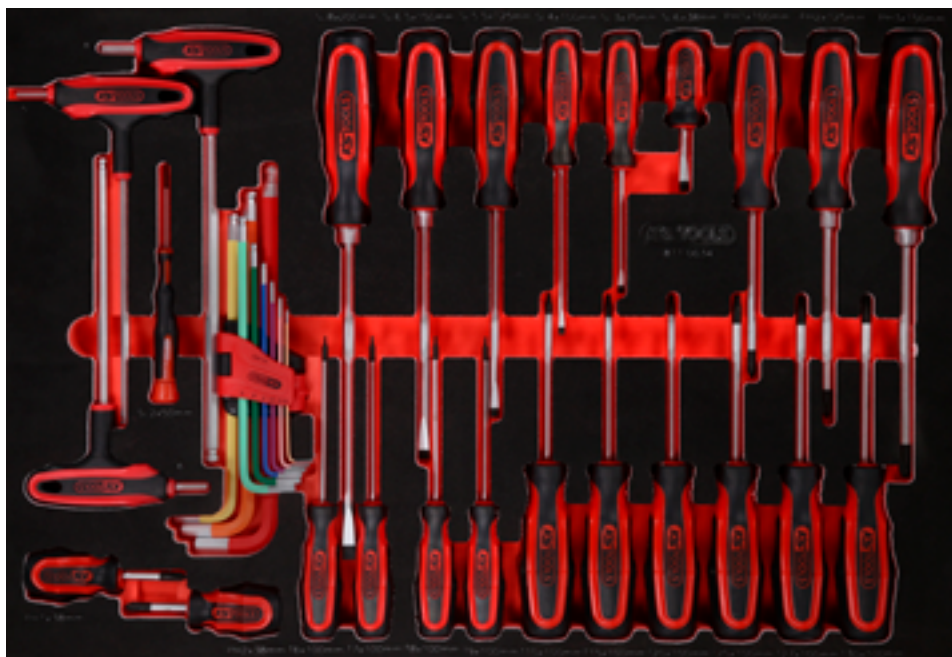

Pos.	Code	Description	pcs
1	159.1134	ERGOTORQUEplus screwdriver, Torx, T6	1
2	159.1135	ERGOTORQUEplus screwdriver, Torx, T7	1
3	159.1030	ERGOTORQUEplus screwdriver, Torx, T8	1
4	159.1031	ERGOTORQUEplus screwdriver, Torx, T9	1
5	159.1032	ERGOTORQUEplus screwdriver, Torx, T10	1
6	159.1033	ERGOTORQUEplus screwdriver, Torx, T15	1
7	159.1034	ERGOTORQUEplus screwdriver, Torx, T20	1
8	159.1035	ERGOTORQUEplus screwdriver, Torx, T25	1
9	159.1036	ERGOTORQUEplus screwdriver, Torx, T27	1
10	159.1037	ERGOTORQUEplus screwdriver, Torx, T30	1
11	159.1024	ERGOTORQUEplus screwdriver for screws PH, PH3, 265 mm	1
12	159.1022	ERGOTORQUEplus screwdriver for screws PH, PH2, 230 mm	1
13	159.1029	ERGOTORQUEplus screwdriver for screws PH, PH1, 205 mm	1
14	159.1001	ERGOTORQUEplus screwdriver for slotted screws, 6 mm, stubby	1
15	159.1002	ERGOTORQUEplus screwdriver for slotted screws, 3 mm, 155 mm	1
16	159.1004	ERGOTORQUEplus screwdriver for slotted screws, 4 mm, 180 mm	1
17	159.1006	ERGOTORQUEplus screwdriver for slotted screws, 5.5 mm, 230 mm	1
18	159.1009	ERGOTORQUEplus screwdriver for slotted screws, 6.5 mm, 255 mm	1
19	159.1011	ERGOTORQUEplus screwdriver for slotted screws, 8 mm, 315 mm	1
20	159.1141	ERGOTORQUEplus screwdriver for screws PH, PH1, stubby	1
21	159.1026	ERGOTORQUEplus screwdriver for screws PH, PH2, stubby	1
22	151.4420	Ball ended hexagon key wrench set, extra long, 9 pcs	9
23	500.7109	Precision screwdriver, slot, 2 mm	1
24	151.8135	T-handle ball ended hexagon key wrench, 6 mm	1
25	151.8134	T-handle ball ended hexagon key wrench, 5 mm	1
26	151.8137	T-handle ball ended hexagon key wrench, 8 mm	1

811.0140

M 1/4" + 3/8" socket spanner set

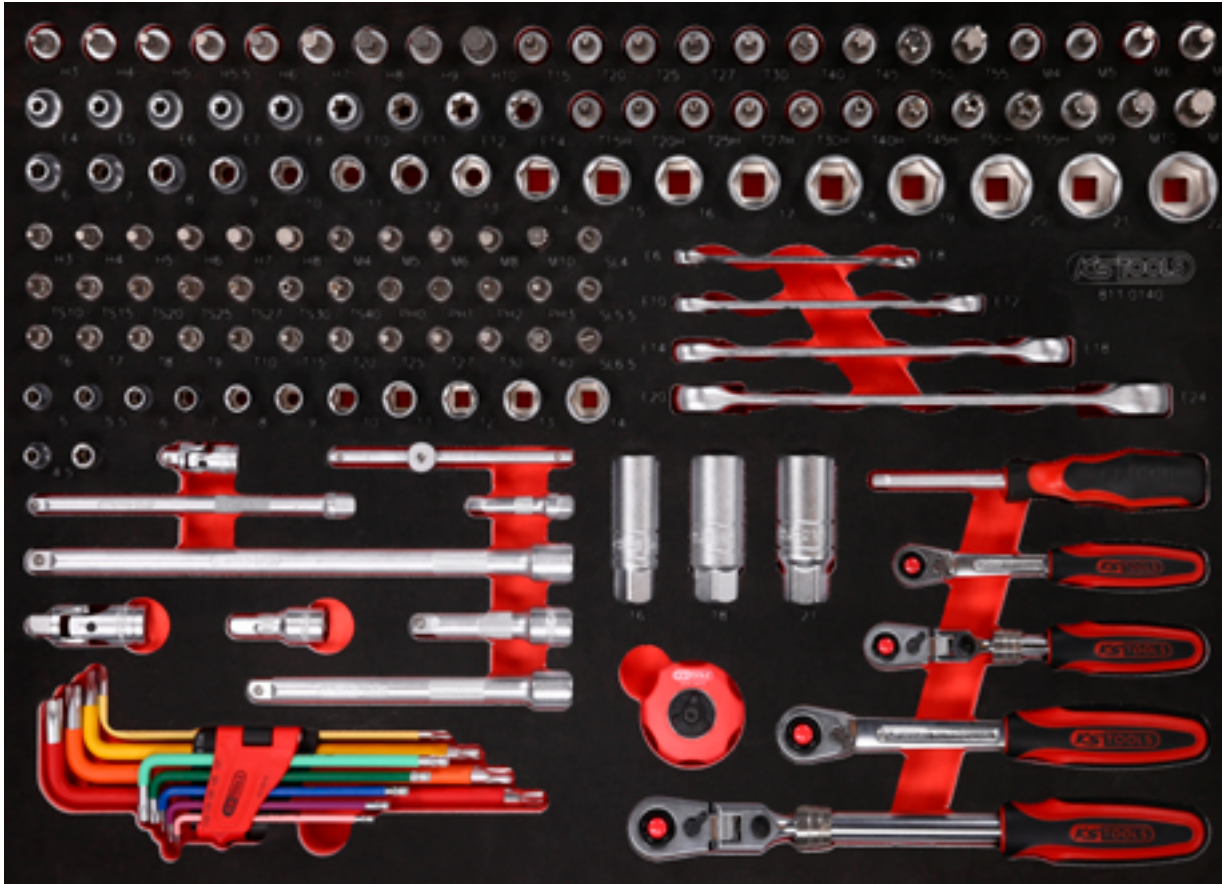

Pos.	Code	Description	pcs	Pos.	Code	Description	pcs	Pos.	Code	Description	pcs
1	911.3863	3/8" Bit socket hexagon, 3 mm	1	24	911.4339	3/8" Torx E Socket, E5	1	47	917.3809	3/8" Hexagonal socket, 9 mm	1
2	911.3864	3/8" Bit socket hexagon, 4 mm	1	25	911.4340	3/8" Torx E Socket, E6	1	48	917.3810	3/8" Hexagonal socket, 10 mm	1
3	911.3865	3/8" Bit socket hexagon, 5 mm	1	26	911.4341	3/8" Torx E Socket, E7	1	49	917.3811	3/8" Hexagonal socket, 11 mm	1
4	911.38655	3/8" Bit socket hexagon, 5,5 mm	1	27	911.4342	3/8" Torx E Socket, E8	1	50	917.3812	3/8" Hexagonal socket, 12 mm	1
5	911.3866	3/8" Bit socket hexagon, 6 mm	1	28	911.4318	3/8" Torx E Socket, E10	1	51	917.3813	3/8" Hexagonal socket, 13 mm	1
6	911.3867	3/8" Bit socket hexagon, 7 mm	1	29	911.4319	3/8" Torx E Socket, E11	1	52	917.3814	3/8" Hexagonal socket, 14 mm	1
7	911.3868	3/8" Bit socket hexagon, 8 mm	1	30	911.4320	3/8" Torx E Socket, E12	1	53	917.3815	3/8" Hexagonal socket, 15 mm	1
8	917.3969	3/8" Bit socket hexagon, 9 mm	1	31	911.4321	3/8" Torx E Socket, E14	1	54	917.3816	3/8" Hexagonal socket, 16 mm	1
9	917.3857	3/8" Bit socket hexagon, 10 mm	1	32	911.3961	3/8" Bit socket Torx tamperproof, TB15	1	55	917.3817	3/8" Hexagonal socket, 17 mm	1
10	911.3869	3/8" Bit socket Torx, T15	1	33	911.3962	3/8" Bit socket Torx tamperproof, TB20	1	56	917.3818	3/8" Hexagonal socket, 18 mm	1
11	911.3870	3/8" Bit socket Torx, T20	1	34	911.3963	3/8" Bit socket Torx tamperproof, TB25	1	57	917.3819	3/8" Hexagonal socket, 19 mm	1
12	911.3871	3/8" Bit socket Torx, T25	1	35	911.3964	3/8" Bit socket Torx tamperproof, TB27	1	58	917.3820	3/8" Hexagonal socket, 20 mm	1
13	911.3872	3/8" Bit socket Torx, T27	1	36	911.3965	3/8" Bit socket Torx tamperproof, TB30	1	59	917.3821	3/8" Hexagonal socket, 21 mm	1
14	911.3873	3/8" Bit socket Torx, T30	1	37	911.3966	3/8" Bit socket Torx tamperproof, TB40	1	60	917.3822	3/8" Hexagonal socket, 22 mm	1
15	911.3874	3/8" Bit socket Torx, T40	1	38	911.3967	3/8" Bit socket Torx tamperproof, TB45	1	61	911.1436	1/4" Bit socket hexagon, 3 mm	1
16	911.3885	3/8" Bit socket Torx, T45	1	39	911.3968	3/8" Bit socket Torx tamperproof, TB50	1	62	911.1437	1/4" Bit socket hexagon, 4 mm	1
17	911.3884	3/8" Bit socket Torx, T50	1	40	911.3969	3/8" Bit socket Torx tamperproof, TB55	1	63	911.1438	1/4" Bit socket hexagon, 5 mm	1
18	911.3888	3/8" Bit socket Torx, T55	1	41	917.3901	3/8" Bit socket spline (XZN), M9	1	64	911.1439	1/4" Bit socket hexagon, 6 mm	1
19	911.3918	3/8" Bit socket spline (XZN), M4	1	42	911.3920	3/8" Bit socket spline (XZN), M10	1	65	911.1440	1/4" Bit socket hexagon, 7 mm	1
20	911.3915	3/8" Bit socket spline (XZN), M5	1	43	917.3903	3/8" Bit socket spline (XZN), M12	1	66	911.1441	1/4" Bit socket hexagon, 8 mm	1
21	911.3916	3/8" Bit socket spline (XZN), M6	1	44	917.3806	3/8" Hexagonal socket, 6 mm	1	67	917.1541	1/4" Bit socket spline (XZN), M4	1
22	911.3917	3/8" Bit socket spline (XZN), M8	1	45	917.3807	3/8" Hexagonal socket, 7 mm	1	68	917.1542	1/4" Bit socket spline (XZN), M5	1
23	911.4338	3/8" Torx E Socket, E4	1	46	917.3808	3/8" Hexagonal socket, 8 mm	1	69	917.1543	1/4" Bit socket spline (XZN), M6	1

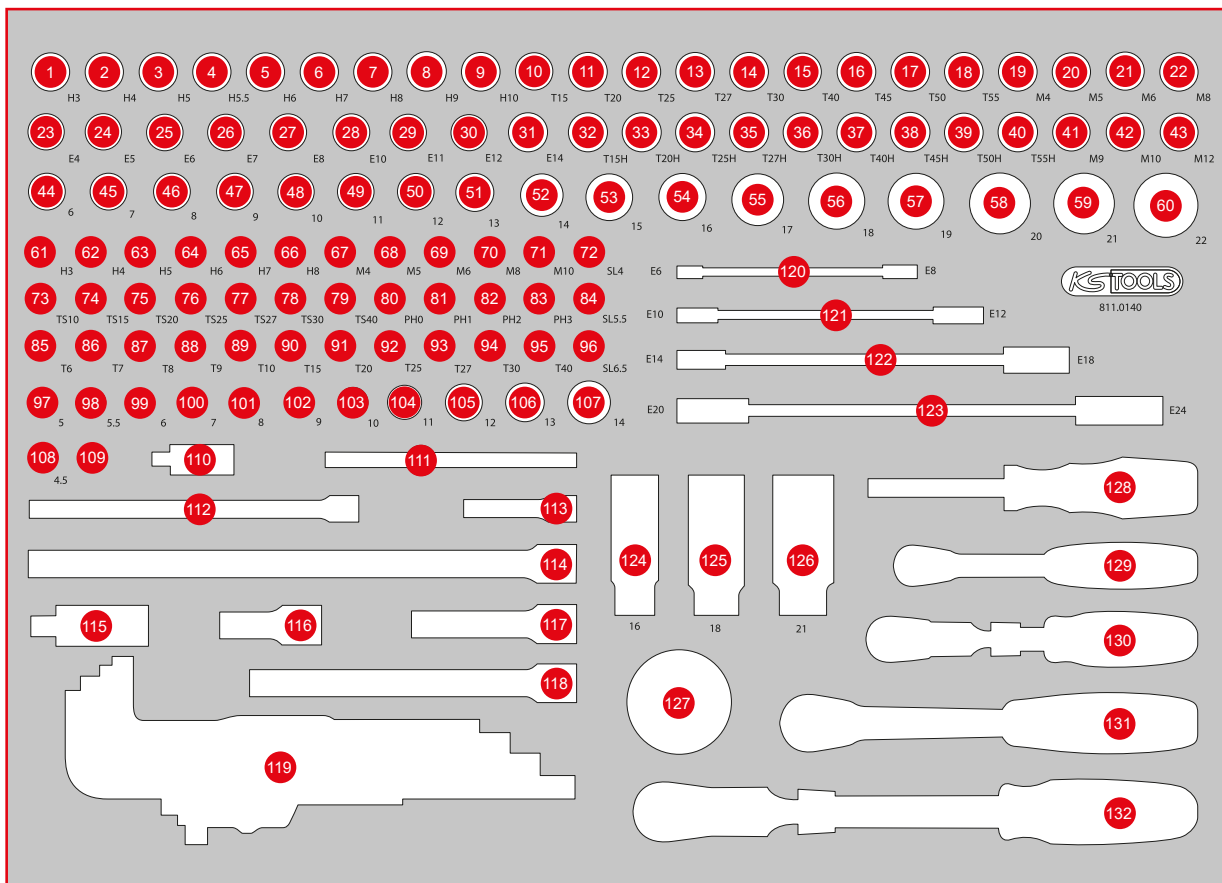

Pos.	Code	Description	pcs	Pos.	Code	Description	pcs	Pos.	Code	Description	pcs
70	917.1545	1/4" Bit socket spline (XZN), M8	1	93	911.1449	1/4" Bit socket Torx, T27	1	116	911.3852	3/8" Extension with knurling, 45 mm	1
71	917.1546	1/4" Bit socket spline (XZN), M10	1	94	911.1446	1/4" Bit socket Torx, T30	1	117	911.3801	3/8" Extension with knurling, 75 mm	1
72	911.1418	1/4" Bit socket slot, 4 mm	1	95	911.1447	1/4" Bit socket Torx, T40	1	118	911.3802	3/8" Extension with knurling, 150 mm	1
73	911.1701	1/4" Bit socket five star tamperproof, TS10	1	96	917.1421	1/4" Bit socket slot, 6,5 mm	1	119	151.5210	Ball head Torx angled socket wrench set, extra long, 9 pcs	9
74	911.1702	1/4" Bit socket five star tamperproof, TS15	1	97	917.1405	1/4" Hexagonal socket, 5 mm	1	120	911.0371	Double ring spanner for Torx E profile, E6 x E8	1
75	911.1703	1/4" Bit socket five star tamperproof, TS20	1	98	917.14055	1/4" Hexagonal socket, 5,5 mm	1	121	911.0373	Double ring spanner for Torx E profile, E10 x E12	1
76	911.1704	1/4" Bit socket five star tamperproof, TS25	1	99	917.1406	1/4" Hexagonal socket, 6 mm	1	122	911.0374	Double ring spanner for Torx E profile, E14 x E18	1
77	911.1705	1/4" Bit socket five star tamperproof, TS27	1	100	917.1407	1/4" Hexagonal socket, 7 mm	1	123	911.0376	Double ring spanner for Torx E profile, E20 x E24	1
78	911.1706	1/4" Bit socket five star tamperproof, TS30	1	101	917.1408	1/4" Hexagonal socket, 8 mm	1	124	911.3804	3/8" Spark plug socket, 16 mm	1
79	911.1707	1/4" Bit socket five star tamperproof, TS40	1	102	917.1409	1/4" Hexagonal socket, 9 mm	1	125	911.3823	3/8" Spark plug socket, 18 mm	1
80	911.1482	1/4" Bit socket, PH0	1	103	917.1410	1/4" Hexagonal socket, 10 mm	1	126	911.3805	3/8" Spark plug socket, 21 mm	1
81	911.1415	1/4" Bit socket, PH1	1	104	917.1411	1/4" Hexagonal socket, 11 mm	1	127	914.1410	Mini hand reversible ratchet, 1/4", 72 teethh	1
82	911.1416	1/4" Bit socket, PH2	1	105	917.1412	1/4" Hexagonal socket, 12 mm	1	128	911.1434	1/4" Square drive screwdriver, 150 mm	1
83	911.1417	1/4" Bit socket, PH3	1	106	917.1413	1/4" Hexagonal socket, 13 mm	1	129	920.1490	1/4" SlimPOWER Reversible ratchet, 72 teeth	1
84	911.1419	1/4" Bit socket slot, 5,5 mm	1	107	917.1414	1/4" Hexagonal socket, 14 mm	1	130	914.1420	1/4" SlimPOWER telescopic-joint reversible ratchet, 72 teeth	1
85	911.4407	1/4" Bit socket Torx, T6	1	108	917.14045	1/4" Hexagonal socket, 4,5 mm	1	131	920.3890	3/8" SlimPOWER Reversible ratchet, 72 teeth	1
86	911.4362	1/4" Bit socket Torx, T7	1	109	911.0101	1/4" socket with magnet	1	132	914.3820	3/8" SlimPOWER Telescopic reversible ratchet, 72 teeth	1
87	911.1448	1/4" Bit socket Torx, T8	1	110	911.1450	1/4" Universal joint	1				
88	911.1478	1/4" Bit socket Torx, T9	1	111	911.1425	Sliding T-bar, 1/4", 110 mm	1				
89	911.1442	1/4" Bit socket Torx, T10	1	112	911.1451	1/4" Extension with hexagon drive, 150 mm	1				
90	911.1443	1/4" Bit socket Torx, T15	1	113	911.1423	1/4" Extension with hexagon drive, 50 mm	1				
91	911.1444	1/4" Bit socket Torx, T20	1	114	911.3803	3/8" Extension with knurling, 250 mm	1				
92	911.1445	1/4" Bit socket Torx, T25	1	115	911.3850	3/8" Universal joint	1				

811.0064

M 1/2" Screwdriver bit set



Pos.	Code	Description	pcs	Pos.	Code	Description	pcs	Pos.	Code	Description	pcs
1	920.1290	1/2" SlimPOWER Reversible ratchet, 72 teeth	1	12	515.0991	SlimPOWER 1/2"Alloy rim impact socket, 15 mm	1	23	911.1656	Hex bit socket, ball ended, long, 1/2", 6 mm	1
2	911.1204	Sliding T-bar, 1/2", 250 mm	1	13	515.0992	SlimPOWER 1/2"Alloy rim impact socket, 17 mm	1	24	911.1657	Hex bit socket, ball ended, long, 1/2", 7 mm	1
3	911.1383	Wobble extension, 1/2", 125 mm	1	14	515.0993	SlimPOWER 1/2"Alloy rim impact socket, 19 mm	1	25	911.1658	Hex bit socket, ball ended, long, 1/2", 8 mm	1
4	911.1202	1/2" Extensions, 125 mm	1	15	515.0994	SlimPOWER 1/2"Alloy rim impact socket, 21 mm	1	26	911.1659	Hex bit socket, ball ended, long, 1/2", 9 mm	1
5	911.1203	1/2" Extensions, 250 mm	1	16	515.0995	SlimPOWER 1/2"Alloy rim impact socket, 22 mm	1	27	911.1660	Hex bit socket, ball ended, long, 1/2", 10 mm	1
6	911.1384	Wobble extension, 1/2", 250 mm	1	17	911.1352	1/2" Bit socket spline (XZN), M8, 110 mm	1	28	911.1526	1/2" Bit socket Torx, long, T45	1
7	911.1381	Wobble extension, 1/2", 50 mm	1	18	911.1359	1/2" Bit socket spline (XZN), M9, 110 mm	1	29	911.1326	1/2" Bit socket hexagon, long, 6 mm	1
8	911.1250	1/2" Universal joint	1	19	911.1353	1/2" Bit socket spline (XZN), M10, 110 mm	1	30	911.1328	1/2" Bit socket hexagon, long, 8 mm	1
9	911.1234	Adaptor, 1/2"F x 3/4"M	1	20	911.1354	1/2" Bit socket spline (XZN), M12, 110 mm	1	31	911.5313	Hex bit socket, ball ended, long, 1/2", 6 mm	1
10	150.1701	3/4" Impact bit socket for spline(XZN®) screws	1	21	911.1355	1/2" Bit socket spline (XZN), M14, 110 mm	1	32	911.1960	1/2" Bit socket hexagon, 10 mm, 140 mm	1
11	911.3545	3/4" 12 Point socket, short, 34 mm	1	22	911.1655	Hex bit socket, ball ended, long, 1/2", 5 mm	1	33	911.1366	1/2" Bit socket Torx, T45	1

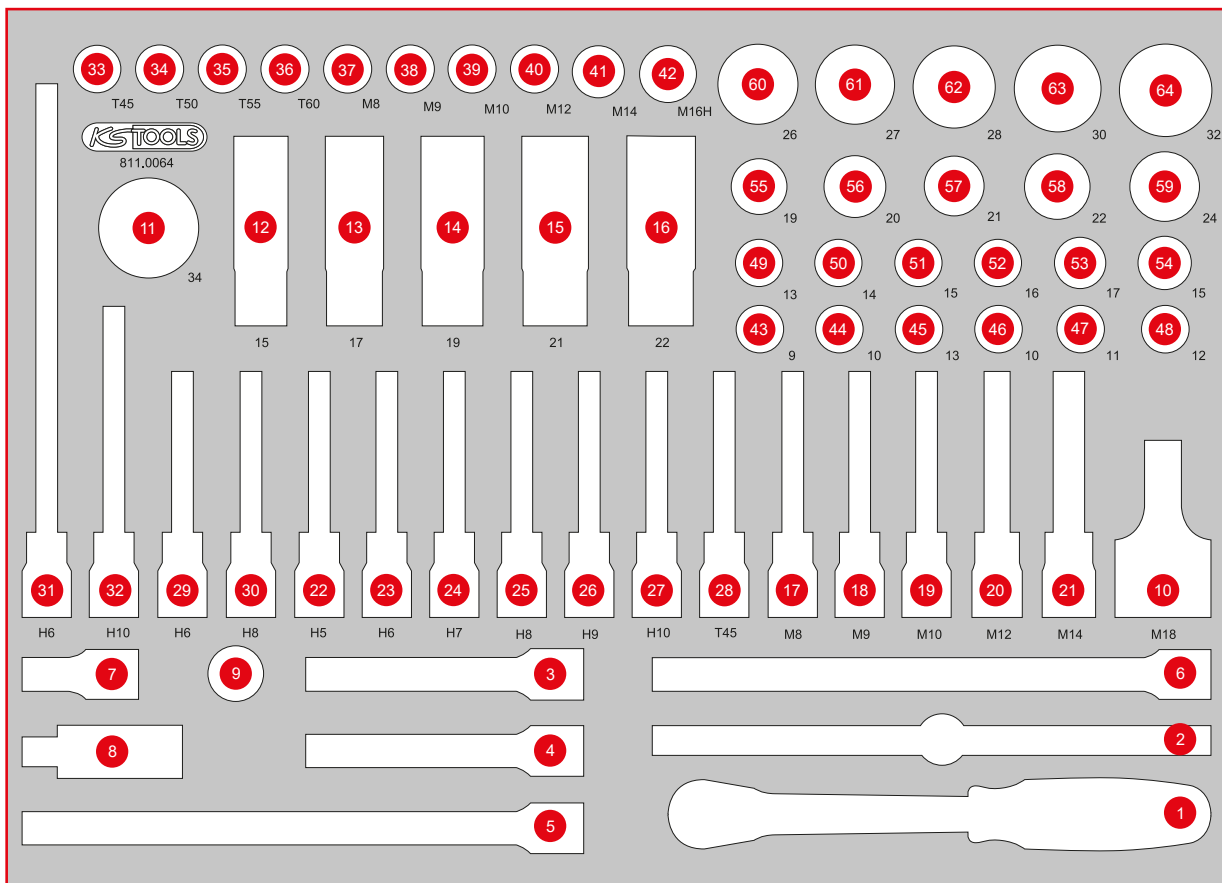

Pos.	Code	Description	pcs	Pos.	Code	Description	pcs	Pos.	Code	Description	pcs
34	911.1367	1/2" Bit socket Torx, T50	1	44	911.1570	1/2" 12 Point socket, 10 mm	1	55	917.1219	1/2" Hexagonal socket, 19 mm	1
35	911.1368	1/2" Bit socket Torx, T55	1	45	911.1573	1/2" 12 Point socket, 13 mm	1	56	917.1220	1/2" Hexagonal socket, 20 mm	1
36	911.1369	1/2" Bit socket Torx, T60	1	46	917.1210	1/2" Hexagonal socket, 10 mm	1	57	917.1221	1/2" Hexagonal socket, 21 mm	1
37	911.1342	1/2" Bit socket spline (XZN), M8, 55 mm	1	47	917.1211	1/2" Hexagonal socket, 11 mm	1	58	917.1222	1/2" Hexagonal socket, 22 mm	1
38	911.1313	1/2" Bit socket spline (XZN), M9, 55 mm	1	48	917.1212	1/2" Hexagonal socket, 12 mm	1	59	917.1224	1/2" Hexagonal socket, 24 mm	1
39	911.1343	1/2" Bit socket spline (XZN), M10, 55 mm	1	49	917.1213	1/2" Hexagonal socket, 13 mm	1	60	917.1343	1/2" Hexagonal socket, 26 mm	1
40	911.1344	1/2" Bit socket spline (XZN), M12, 55 mm	1	50	917.1214	1/2" Hexagonal socket, 14 mm	1	61	917.1227	1/2" Hexagonal socket, 27 mm	1
41	911.1345	1/2" Bit socket spline (XZN), M14, 55 mm	1	51	917.1215	1/2" Hexagonal socket, 15 mm	1	62	917.1344	1/2" Hexagonal socket, 28 mm	1
42	911.1348	1/2" Bit socket spline (XZN) tamperproof, M16, 55 mm	1	52	917.1216	1/2" Hexagonal socket, 16 mm	1	63	917.1230	1/2" Hexagonal socket, 30 mm	1
43	917.1362	1/2" 12 Point socket, 9 mm	1	53	917.1217	1/2" Hexagonal socket, 17 mm	1	64	917.1232	1/2" Hexagonal socket, 32 mm	1
				54	917.1218	1/2" Hexagonal socket, 18 mm	1				

M Screw spanner set

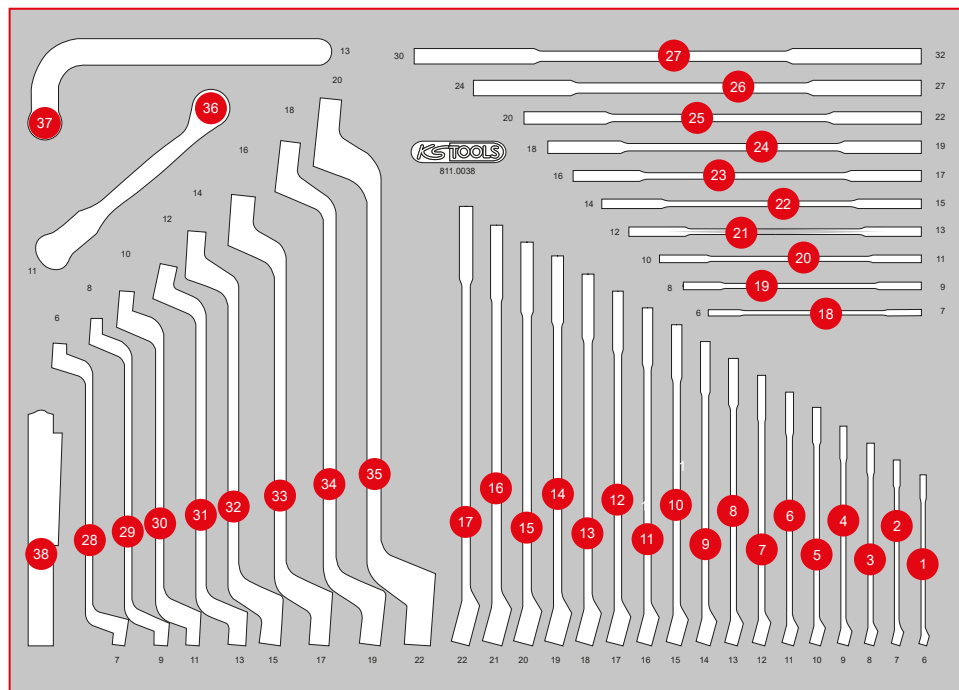

Pos.	Code	Description	pcs
1	517.0606	Combination spanners, offset, 6 mm	1
2	517.0607	Combination spanners, offset, 7 mm	1
3	517.0608	Combination spanners, offset, 8 mm	1
4	517.0609	Combination spanners, offset, 9 mm	1
5	517.0610	Combination spanners, offset, 10 mm	1
6	517.0611	Combination spanners, offset, 11 mm	1
7	517.0612	Combination spanners, offset, 12 mm	1
8	517.0613	Combination spanners, offset, 13 mm	1
9	517.0614	Combination spanners, offset, 14 mm	1
10	517.0615	Combination spanners, offset, 15 mm	1
11	517.0616	Combination spanners, offset, 16 mm	1
12	517.0617	Combination spanners, offset, 17 mm	1
13	517.0618	Combination spanners, offset, 18 mm	1
14	517.0619	Combination spanners, offset, 19 mm	1
15	517.0620	Combination spanners, offset, 20 mm	1
16	517.0621	Combination spanners, offset, 21 mm	1
17	517.0622	Combination spanners, offset, 22 mm	1
18	517.0701	Double open ended spanners, 6 x 7 mm	1
19	517.0702	Double open ended spanners, 8 x 9 mm	1
20	517.0704	Double open ended spanners, 10 x 11 mm	1
21	517.0707	Double open ended spanners, 12 x 13 mm	1
22	517.0709	Double open ended spanners, 14 x 15 mm	1
23	517.0710	Double open ended spanners, 16 x 17 mm	1
24	517.0712	Double open ended spanners, 18 x 19 mm	1
25	517.0714	Double open ended spanners, 20 x 22 mm	1
26	517.0716	Double open ended spanners, 24 x 27 mm	1
27	517.0718	Double open ended spanners, 30 x 32 mm	1
28	517.0801	Double ring spanner, offset, 6 x 7 mm	1
29	517.0802	Double ring spanner, offset, 8 x 9 mm	1
30	517.0804	Double ring spanner, offset, 10 x 11 mm	1
31	517.0807	Double ring spanner, offset, 12 x 13 mm	1
32	517.0809	Double ring spanner, offset, 14 x 15 mm	1
33	517.0810	Double ring spanner, offset, 16 x 17 mm	1
34	517.0812	Double ring spanner, offset, 18 x 19 mm	1
35	517.0813	Double ring spanner, offset, 20 x 22 mm	1
36	518.0381	CHROMEplus Open double ring spanner, with flexible joint, 11 mm	1
37	152.1396	Injector pump wrench 13 mm	1
38	150.4370	perfectLight torch 85 lumen	1

M Pliers, Hammer and chisel set



Pos.	Code	Description	pcs
1	156.0236	Pin punch, Ø 2 mm, cylindrical shaft	1
2	156.0231	Pin punch, Ø 3 mm, cylindrical shaft	1
3	156.0232	Pin punch, Ø 4 mm, cylindrical shaft	1
4	156.0233	Pin punch, Ø 5 mm, cylindrical shaft	1
5	156.0234	Pin punch, Ø 6 mm, cylindrical shaft	1
6	156.0235	Pin punch, Ø 8 mm, cylindrical shaft	1
7	156.0253	Flat chisel, octagon, 16 mm	1
8	156.0254	Flat chisel, octagon, 18 mm	1
9	156.0243	Centre punch, octagon 10 mm	1
10	156.0242	Cross chisel, octagon, 7 mm	1
11	115.1012	ERGOTORQUE diagonal side cutter, 160 mm	1
12	115.1021	ERGOTORQUE combination pliers, 180 mm	1
13	115.1024	ERGOTORQUE long nose pliers serrated cutter, 200 mm	1
14	115.1231	Multifunction pliers for insulated and non insulated cable terminals, 220 mm	1
15	115.1033	Self grip wrench, 220 mm	1
16	115.2010	Water pump pliers, 240 mm	1
17	115.1239	Self regulating wire stripper, 0,2 - 6 mm	1
18	500.1029	Circlip pliers for external circlips, 160 mm	1
19	907.2232	Gasket scraper, 25 x 200 mm	1
20	201.2320	Steel wire brake saddle wire brush 2 rowed, straight	1
21	142.1402	Fitters Hammer, fibreglas handle, 400 g	1
22	140.5252	Recoil free soft faced Hammer, 400 g	1
23	911.8138	Trim plastic wedge, 195 x 30 mm	1

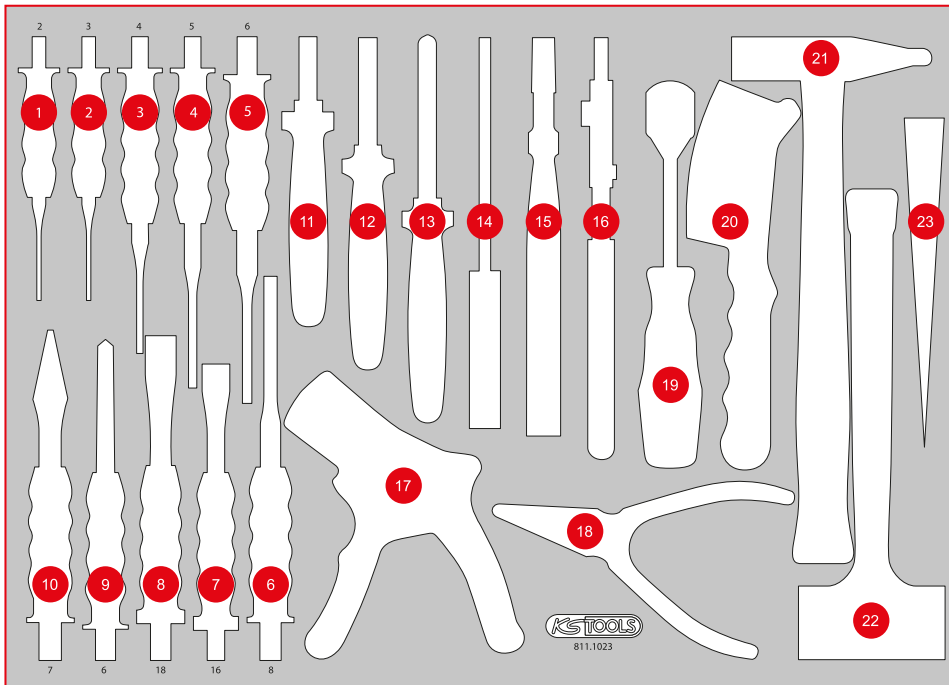

P10

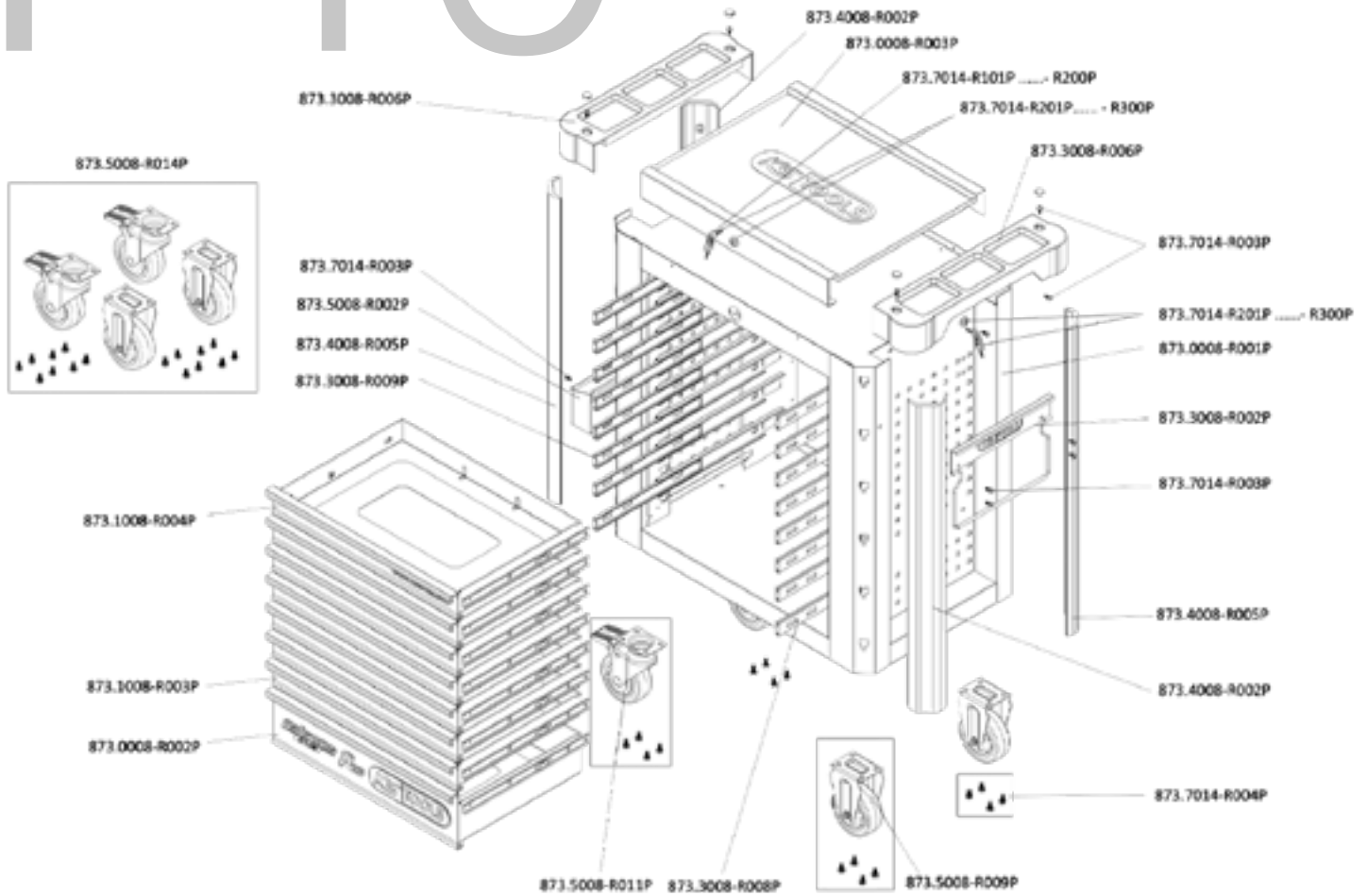

INDIVIDUAL PARTS LIST

Item No.	Description	Amount
873.7014-R101P...	Replacement key for PERFORMANCEplus workshop trolley lock number xyz	2
873.7014-R201P...	Lock with 2 keys for PERFORMANCEplus workshop trolley lock number xyz	2
873.0008-R001P	Body with handle	1
873.0008-R002P	Compartment with logo and ball-bearing guide, 568x398x145 mm	1
873.0008-R003P	Stainless steel worktop	1
873.1008-R003P	Compartment with ball-bearing guide, for workshop trolley P10/P10TC/P15, 568x398x65 mm	6
873.1008-R004P	Compartment with website and ball-bearing guide, for workshop trolley P10/P15, 568x398x65 mm	1
873.3008-R002P	Paper roll holder for PERFORMANCEplus workshop trolley	1
873.3008-R006P	Storage for work surface	2
873.3008-R008P	Full extension (with ball-bearing guide) with automatic retraction	8
873.3008-R009P	Full extension (with ball-bearing guide) with automatic retraction	8
873.4008-R002P	Plastic bumpers	2
873.4008-R005P	Plastic bumpers	2
873.5008-R002P	Can holder for PERFORMANCEplus workshop trolley	1
873.5008-R009P	Fixed castors for PERFORMANCEplus workshop trolley, incl. screws	2
873.5008-R011P	Swivel castors with brakes, for PERFORMANCEplus workshop trolley, incl. screws	2
873.5008-R014P	Roller set for PERFORMANCEplus workshop trolley, incl. screws	1
873.7014-R003P	M6x12 screws for PERFORMANCEplus workshop trolley accessories	14
873.7014-R004P	M8 screws for PERFORMANCEplus workshop trolley rollers (16 pcs.)	1



873.7014-R101P...R200P
Replacement key for lock number xyz



873.7014-R201P...R300P
Lock with 2 keys for lock number xyz



873.3008-R008P
Full extension (with ball-bearing guide) with automatic retraction, right



873.3008-R009P
Full extension (with ball-bearing guide) with automatic retraction, left



873.5008-R009P
Fixed castors, incl. screws



873.5008-R011P
Swivel castors with brakes, incl. screws



873.5008-R014P
Roller set, incl. screws



873.0008-R003P
Stainless steel work surface



873.3008-R006P
Storage for work surface, including screw cover, usable on both sides



873.1008-R004P
Compartment with website and ball-bearing guide, 568x398x65 mm



873.1008-R003P
Compartment with ball-bearing guide, 568x398x65 mm



873.0008-R002P
Compartment with logo and ball-bearing guide, 568x398x145 mm



873.5008-R002P
Can holder, 310 mm



873.3008-R002P
Paper roll holder, 320 mm



873.4008-R005P
Plastic bumpers, front left, back right



873.4008-R002P
Plastic bumpers, front right, back left



873.7014-R004P
M8 screws (16 pcs.)



873.7014-R003P
M6x12 screw (1 pcs.)



873.0008-R001P
Body with handle



A thousand great parts for tough guys!

