



Features

- RoHS compliant*
- Surface Mount SMC package
- Standoff Voltage: 5.0 to 495 volts
- Power Dissipation: 1500 watts

Applications

- IEC 61000-4-2 ESD (Min. Level 4)
- IEC 61000-4-4 EFT
- IEC 61000-4-5 Surge

SMCJ Transient Voltage Suppressor Diode Series

General Information

The markets of portable communications, computing and video equipment are challenging the semiconductor industry to develop increasingly smaller electronic components.

Bourns offers Transient Voltage Suppressor Diodes for surge and ESD protection applications, in compact chip package DO-214AB (SMC) size format. The Transient Voltage Suppressor series offers a choice of Working Peak Reverse Voltage from 5 V up to 495 V and Breakdown Voltage up to 550 V. Typical fast response times are less than 1.0 picosecond for unidirectional devices and less than 5.0 picoseconds for bidirectional devices from 0 V to Minimum Breakdown Voltage.

Bourns® Chip Diodes conform to JEDEC standards, are easy to handle with standard pick and place equipment and their flat configuration minimizes roll away.

Agency Recognition

Description	
UL	File Number: E153537

Electrical Characteristics (@ T_A = 25 °C Unless Otherwise Noted)

Parameter	Symbol	Value	Unit
Minimum Peak Pulse Power Dissipation (T _P = 1 ms) (Note 1,2)	P _{PK}	1500	Watts
Peak Forward Surge Current 8.3 ms Single Half Sine Wave Superimposed on Rated Load (JEDEC Method) (Note 3)	I _{FSM}	200	Amps
Steady State Power Dissipation @ T _L = 75 °C	P _{M(AV)}	5.0	Watts
Maximum Instantaneous Forward Voltage @ I _{PP} = 100 A (For Unidirectional Units Only)	V _F	3.5 5.0	Volts
Operating Temperature Range	T _J	-55 to +150	°C
Storage Temperature Range	T _{STG}	-55 to +150	°C

1. Non-repetitive current pulse, per Pulse Waveform graph and derated above T_A = 25 °C per Pulse Derating Curve.
2. Thermal Resistance Junction to Lead.
3. 8.3 ms Single Half-Sine Wave duty cycle = 4 pulses maximum per minute (unidirectional units only).

BOURNS®

Asia-Pacific:

Tel: +886-2 2562-4117 • Email: asiacus@bourns.com

Europe:

Tel: +36 88 885 877 • Email: eurocus@bourns.com

The Americas:

Tel: +1-951 781-5500 • Email: americus@bourns.com

www.bourns.com

How to Order

Package	SMCJ	5.0	CA - H
SMCJ = SMC/DO-214AB			
Working Peak Reverse Voltage	5.0 = 5.0 V _{RWM} (Volts)		
Suffix	A = 5 % Tolerance Unidirectional Device CA = 5 % Tolerance Bidirectional Device		
Reel	(blank) = 13 inch reel -H = 7 inch reel		



WARNING Cancer and Reproductive Harm - www.P65Warnings.ca.gov

*RoHS Directive 2015/863, Mar 31, 2015 and Annex.
Specifications are subject to change without notice.

Users should verify actual device performance in their specific applications.

The products described herein and this document are subject to specific legal disclaimers as set forth on the last page of this document, and at www.bourns.com/docs/legal/disclaimer.pdf.

SMCJ Transient Voltage Suppressor Diode Series

Electrical Characteristics (@ T_A = 25 °C Unless Otherwise Noted)

Unidirectional Device		Bidirectional Device		Breakdown Voltage V _{BR} (Volts)			Working Peak Reverse Voltage	Maximum Reverse Leakage @ V _{RWM}	Maximum Reverse Voltage @ I _{RSM}	Maximum Reverse Surge Current
Part No.	Marking	Part No.	Marking	Min.	Max.	@ I _T (mA)	V _{RWM} (V)	I _R (μA)	V _{RSM} (V)	I _{RSM} (A)
SMCJ5.0A	GDE	SMCJ5.0CA	BDE	6.40	7.00	10	5	800	9.2	163
SMCJ6.0A	GDG	SMCJ6.0CA	BDG	6.67	7.37	10	6	800	10.3	145.7
SMCJ6.5A	GDK	SMCJ6.5CA	BDK	7.22	7.98	10	6.5	500	11.2	134
SMCJ7.0A	GDM	SMCJ7.0CA	BDM	7.78	8.60	10	7	200	12	125
SMCJ7.5A	GDP	SMCJ7.5CA	BDP	8.33	9.21	1	7.5	100	12.9	116.3
SMCJ8.0A	GDR	SMCJ8.0CA	BDR	8.89	9.83	1	8	50	13.6	110.3
SMCJ8.5A	GDT	SMCJ8.5CA	BDT	9.44	10.4	1	8.5	20	14.4	104.2
SMCJ9.0A	GDV	SMCJ9.0CA	BDV	10.0	11.1	1	9	10	15.4	97.4
SMCJ10A	GDY	SMCJ10CA	BDY	11.1	12.3	1	10	5	17	88.3
SMCJ11A	GDZ	SMCJ11CA	BDZ	12.2	13.5	1	11	1	18.2	82.5
SMCJ12A	GEE	SMCJ12CA	BEE	13.3	14.7	1	12	1	19.9	75.4
SMCJ13A	GEG	SMCJ13CA	BEG	14.4	15.9	1	13	1	21.5	69.8
SMCJ14A	GEK	SMCJ14CA	BEK	15.6	17.2	1	14	1	23.2	64.7
SMCJ15A	GEM	SMCJ15CA	BEM	16.7	18.5	1	15	1	24.4	61.5
SMCJ16A	GEP	SMCJ16CA	BEP	17.8	19.7	1	16	1	26	57.7
SMCJ17A	GER	SMCJ17CA	BER	18.9	20.9	1	17	1	27.6	54.4
SMCJ18A	GET	SMCJ18CA	BET	20.0	22.1	1	18	1	29.2	51.4
SMCJ20A	GEV	SMCJ20CA	BEV	22.2	24.5	1	20	1	32.4	46.3
SMCJ22A	GEX	SMCJ22CA	BEX	24.4	26.9	1	22	1	35.5	42.3
SMCJ24A	GEZ	SMCJ24CA	BEZ	26.7	29.5	1	24	1	38.9	38.6
SMCJ26A	GFE	SMCJ26CA	BFE	28.9	31.9	1	26	1	42.1	35.7
SMCJ28A	GFG	SMCJ28CA	BFG	31.1	34.4	1	28	1	45.4	33.1
SMCJ30A	GFK	SMCJ30CA	BFK	33.3	36.8	1	30	1	48.4	31
SMCJ33A	GFM	SMCJ33CA	BFM	36.7	40.6	1	33	1	53.3	28.1
SMCJ36A	GFP	SMCJ36CA	BFP	40	44.2	1	36	1	58.1	25.9
SMCJ40A	GFR	SMCJ40CA	BFR	44.4	49.1	1	40	1	64.5	23.3
SMCJ43A	GFT	SMCJ43CA	BFT	47.8	52.8	1	43	1	69.4	21.7
SMCJ45A	GFV	SMCJ45CA	BFV	50	55.3	1	45	1	72.7	20.6
SMCJ48A	GFX	SMCJ48CA	BFX	53.3	58.9	1	48	1	77.4	19.4
SMCJ51A	GFZ	SMCJ51CA	BFZ	56.7	62.7	1	51	1	82.4	18.2
SMCJ54A	GGE	SMCJ54CA	BGE	60	66.3	1	54	1	87.1	17.3
SMCJ58A	GGG	SMCJ58CA	BGG	64.4	71.2	1	58	1	93.6	16.1
SMCJ60A	GGK	SMCJ60CA	BGK	66.7	73.7	1	60	1	96.8	15.5
SMCJ64A	GGM	SMCJ64CA	BGM	71.1	78.6	1	64	1	103	14.6
SMCJ70A	GGP	SMCJ70CA	BGP	77.8	86.0	1	70	1	113	13.3
SMCJ75A	GGR	SMCJ75CA	BGR	83.3	92.1	1	75	1	121	12.4
SMCJ78A	GGT	SMCJ78CA	BGT	86.7	95.8	1	78	1	126	11.9
SMCJ85A	GGV	SMCJ85CA	BGV	94.4	104	1	85	1	137	11
SMCJ90A	GGX	SMCJ90CA	BGX	100	111	1	90	1	146	10.3
SMCJ100A	GGZ	SMCJ100CA	BGZ	111	123	1	100	1	162	9.3
SMCJ110A	GHE	SMCJ110CA	BHE	122	135	1	110	1	177	8.4
SMCJ120A	GHG	SMCJ120CA	BHG	133	147	1	120	1	193	7.9
SMCJ130A	GHK	SMCJ130CA	BHK	144	159	1	130	1	209	7.2
SMCJ150A	GHM	SMCJ150CA	BHM	167	185	1	150	1	243	6.2
SMCJ160A	GHP	SMCJ160CA	BHP	178	197	1	160	1	259	5.8
SMCJ170A	GHR	SMCJ170CA	BHR	189	209	1	170	1	275	5.5
SMCJ180A	GHT	SMCJ180CA	BHT	201	222	1	180	1	292	5.1
SMCJ200A	GHV	SMCJ200CA	BHV	224	247	1	200	1	324	4.6
SMCJ220A	GHX	SMCJ220CA	BHX	246	272	1	220	1	356	4.2
SMCJ250A	GHZ	SMCJ250CA	BHZ	279	309	1	250	1	405	3.7
SMCJ300A	GJE	SMCJ300CA	BJE	335	371	1	300	1	486	3.1
SMCJ350A	GJG	SMCJ350CA	BJG	391	432	1	350	1	567	2.6
SMCJ400A	GJK	SMCJ400CA	BJK	447	494	1	400	1	648	2.3
SMCJ408A	408A	SMCJ408CA	408CA	456	504	1	408	1	658	2.3
SMCJ440A	GJM	SMCJ440CA	BJM	492	543	1	440	1	713	2.1
SMCJ495A	495A	SMCJ495CA	495CA	522.5	577.5	1	495	1	760	2.0

Notes:

- Suffix 'A' denotes a 5 % tolerance unidirectional device.
- Suffix 'CA' denotes a 5 % tolerance bidirectional device.
- For bidirectional devices with a V_R of 10 volts or less, the I_R limit is double.

Specifications are subject to change without notice.

Users should verify actual device performance in their specific applications.

The products described herein and this document are subject to specific legal disclaimers as set forth on the last page of this document, and at www.bourns.com/docs/legal/disclaimer.pdf.

SMCJ Transient Voltage Suppressor Diode Series



Product Dimensions

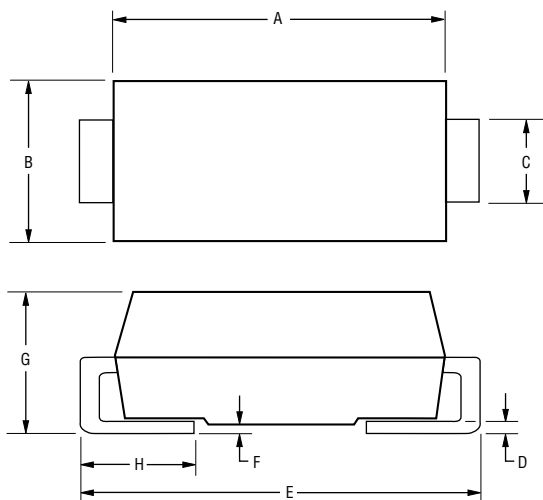

Dimension	SMC (DO-214AB)
A	$\frac{6.60 - 7.11}{(0.260 - 0.280)}$
B	$\frac{5.59 - 6.22}{(0.220 - 0.245)}$
C	$\frac{2.90 - 3.20}{(0.115 - 0.125)}$
D	$\frac{0.15 - 0.31}{(0.006 - 0.012)}$
E	$\frac{7.75 - 8.13}{(0.305 - 0.320)}$
F	$\frac{0.05 - 0.202}{(0.002 - 0.008)}$
G	$\frac{2.00 - 2.62}{(0.079 - 0.103)}$
H	$\frac{0.76 - 1.52}{(0.030 - 0.060)}$

DIMENSIONS: $\frac{\text{MM}}{\text{(INCHES)}}$

Recommended Footprint

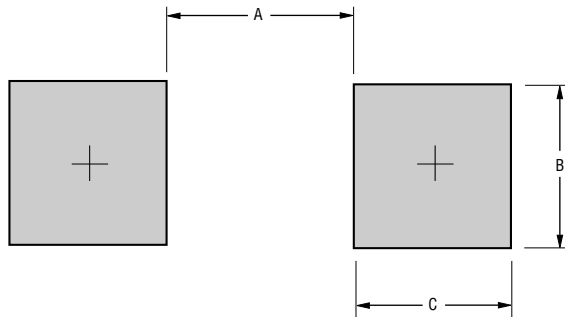

Dimension	SMC (DO-214AB)
A (Max.)	$\frac{4.69}{(0.185)}$
B (Min.)	$\frac{3.07}{(0.121)}$
C (Min.)	$\frac{1.52}{(0.060)}$

DIMENSIONS: $\frac{\text{MM}}{\text{(INCHES)}}$

Physical Specifications

CaseMolded plastic per UL Class 94V-0
 Polarity..... Cathode band indicates unidirectional device
 No cathode band indicates bidirectional device
 Weight0.21 grams

SMCJ Transient Voltage Suppressor Diode Series



Rating & Characteristic Curves

Pulse Derating Curve

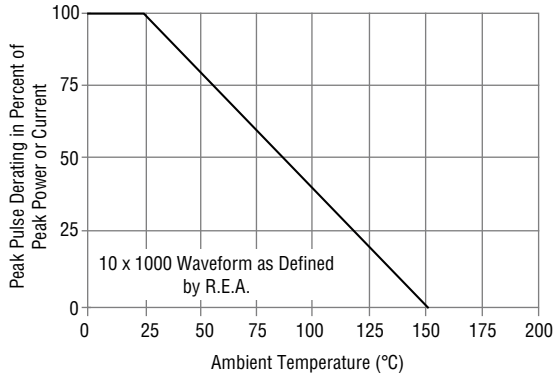

Maximum Non-Repetitive Surge Current

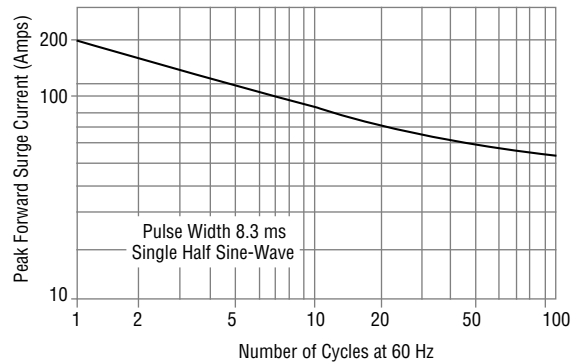

Pulse Waveform

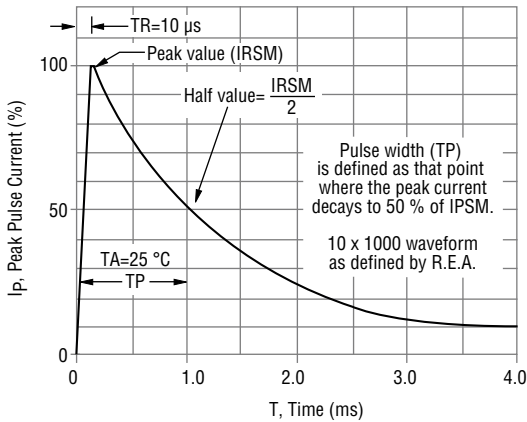

Typical Junction Capacitance

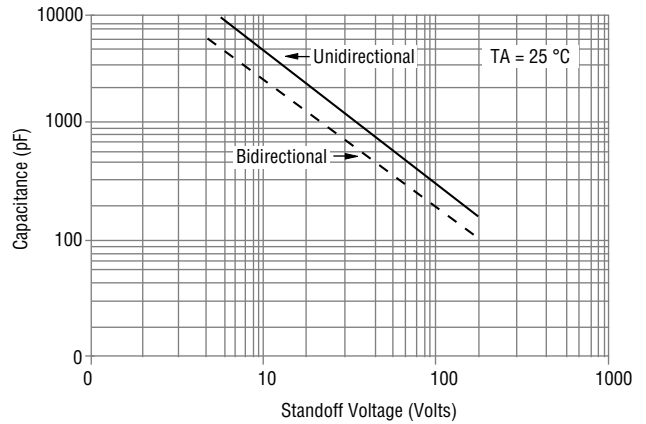

Pulse Rating Curve

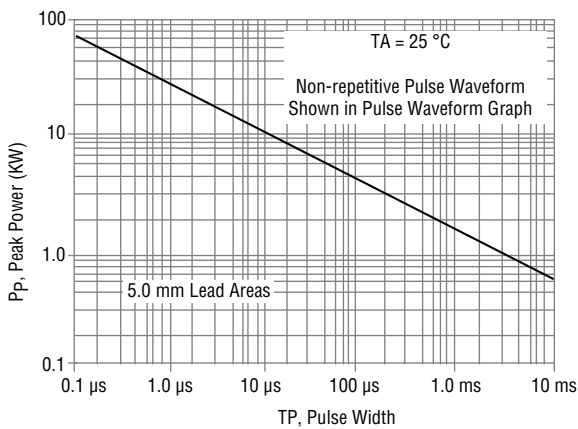

Steady State Power Derating Curve

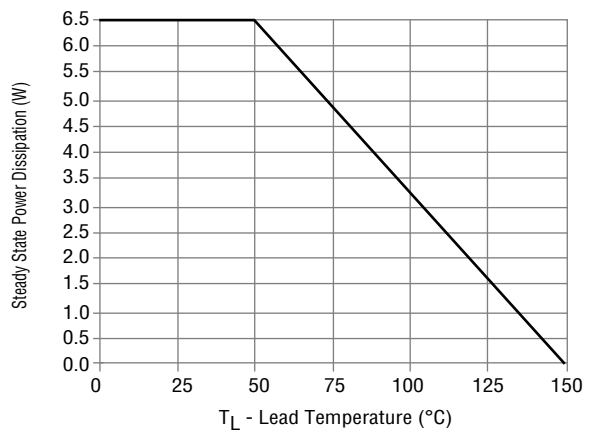

Specifications are subject to change without notice.

Users should verify actual device performance in their specific applications.

The products described herein and this document are subject to specific legal disclaimers as set forth on the last page of this document, and at www.bourns.com/docs/legal/disclaimer.pdf.

SMCJ Transient Voltage Suppressor Diode Series

BOURNS®

Packaging Information

The product will be dispensed in tape and reel format (see diagram below).

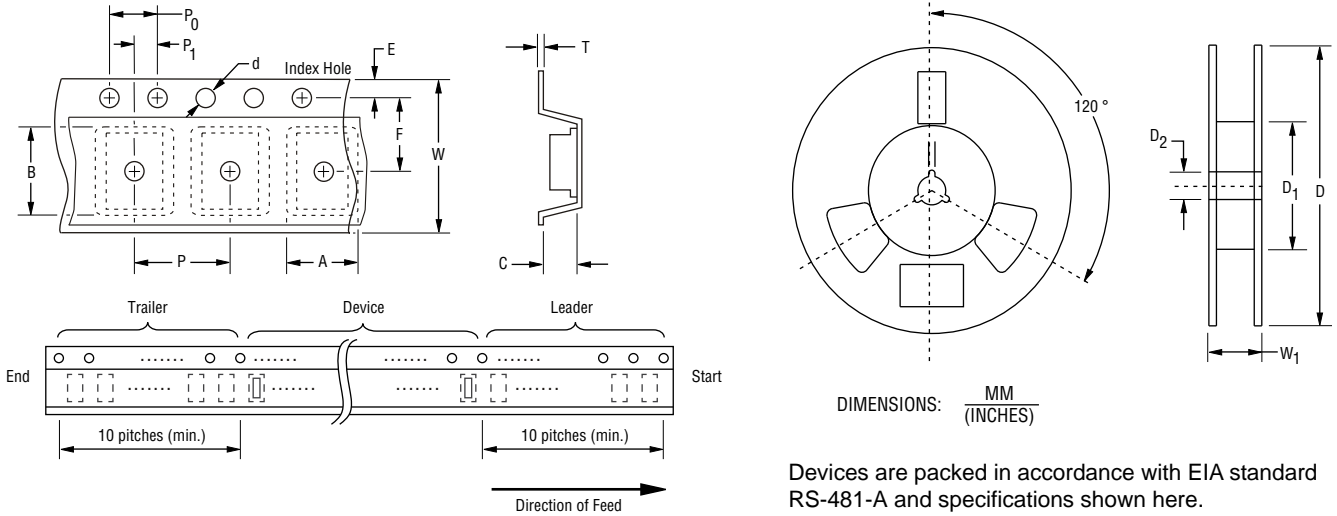

Devices are packed in accordance with EIA standard RS-481-A and specifications shown here.

Item	Symbol	SMC (DO-214AB)	
		7 Inch Reel	13 Inch Reel
Carrier Width	A	6.0 ± 2.0 (0.236 - 0.079)	
Carrier Length	B	8.3 ± 0.20 (0.327 ± 0.008)	
Carrier Depth	C	2.5 ± 0.20 (0.098 ± 0.008)	
Sprocket Hole	d	1.50 ± 0.10 (0.059 ± 0.004)	
Reel Outside Diameter	D	$\frac{178}{(7.008)}$	$\frac{330}{(12.992)}$
Reel Inner Diameter	D ₁	$\frac{50.0}{(1.969)}$ MIN.	
Feed Hole Diameter	D ₂	$13.0 +0.50/-0.20$ (0.512 +0.020/-0.008)	
Sprocket Hole Position	E	1.75 ± 0.10 (0.069 ± 0.004)	
Punch Hole Position	F	7.50 ± 0.10 (0.295 ± 0.004)	
Punch Hole Pitch	P	8.00 ± 0.10 (0.315 ± 0.004)	
Sprocket Hole Pitch	P ₀	4.00 ± 0.10 (0.157 ± 0.004)	
Embossment Center	P ₁	2.00 ± 0.10 (0.079 ± 0.004)	
Overall Tape Thickness	T	0.30 ± 0.10 (0.012 ± 0.004)	
Tape Width	W	16.00 ± 0.30 (0.630 ± 0.012)	
Reel Width	W ₁	$\frac{22.4}{(0.882)}$ MAX.	
Quantity per Reel	--	500	3,000

REV. 09/19

Specifications are subject to change without notice.

Users should verify actual device performance in their specific applications.

The products described herein and this document are subject to specific legal disclaimers as set forth on the last page of this document, and at www.bourns.com/docs/legal/disclaimer.pdf.

This legal disclaimer applies to purchasers and users of Bourns® products manufactured by or on behalf of Bourns, Inc. and its affiliates (collectively, “Bourns”).

Unless otherwise expressly indicated in writing, Bourns® products and data sheets relating thereto are subject to change without notice. Users should check for and obtain the latest relevant information and verify that such information is current and complete before placing orders for Bourns® products.

The characteristics and parameters of a Bourns® product set forth in its data sheet are based on laboratory conditions, and statements regarding the suitability of products for certain types of applications are based on Bourns’ knowledge of typical requirements in generic applications. The characteristics and parameters of a Bourns® product in a user application may vary from the data sheet characteristics and parameters due to (i) the combination of the Bourns® product with other components in the user’s application, or (ii) the environment of the user application itself. The characteristics and parameters of a Bourns® product also can and do vary in different applications and actual performance may vary over time. Users should always verify the actual performance of the Bourns® product in their specific devices and applications, and make their own independent judgments regarding the amount of additional test margin to design into their device or application to compensate for differences between laboratory and real world conditions.

Unless Bourns has explicitly designated an individual Bourns® product as meeting the requirements of a particular industry standard (e.g., ISO/TS 16949) or a particular qualification (e.g., UL listed or recognized), Bourns is not responsible for any failure of an individual Bourns® product to meet the requirements of such industry standard or particular qualification. Users of Bourns® products are responsible for ensuring compliance with safety-related requirements and standards applicable to their devices or applications.

Bourns® products are not recommended, authorized or intended for use in nuclear, lifesaving, life-critical or life-sustaining applications, nor in any other applications where failure or malfunction may result in personal injury, death, or severe property or environmental damage. Unless expressly and specifically approved in writing by two authorized Bourns representatives on a case-by-case basis, use of any Bourns® products in such unauthorized applications might not be safe and thus is at the user’s sole risk. Life-critical applications include devices identified by the U.S. Food and Drug Administration as Class III devices and generally equivalent classifications outside of the United States.

Bourns expressly identifies those Bourns® standard products that are suitable for use in automotive applications on such products’ data sheets in the section entitled “Applications.” Unless expressly and specifically approved in writing by two authorized Bourns representatives on a case-by-case basis, use of any other Bourns® standard products in an automotive application might not be safe and thus is not recommended, authorized or intended and is at the user’s sole risk. If Bourns expressly identifies a sub-category of automotive application in the data sheet for its standard products (such as infotainment or lighting), such identification means that Bourns has reviewed its standard product and has determined that if such Bourns® standard product is considered for potential use in automotive applications, it should only be used in such sub-category of automotive applications. Any reference to Bourns® standard product in the data sheet as compliant with the AEC-Q standard or “automotive grade” does not by itself mean that Bourns has approved such product for use in an automotive application.

Bourns® standard products are not tested to comply with United States Federal Aviation Administration standards generally or any other generally equivalent governmental organization standard applicable to products designed or manufactured for use in aircraft or space applications. Bourns expressly identifies Bourns® standard products that are suitable for use in aircraft or space applications on such products’ data sheets in the section entitled “Applications.” Unless expressly and specifically approved in writing by two authorized Bourns representatives on a case-by-case basis, use of any other Bourns® standard product in an aircraft or space application might not be safe and thus is not recommended, authorized or intended and is at the user’s sole risk.

The use and level of testing applicable to Bourns® custom products shall be negotiated on a case-by-case basis by Bourns and the user for which such Bourns® custom products are specially designed. Absent a written agreement between Bourns and the user regarding the use and level of such testing, the above provisions applicable to Bourns® standard products shall also apply to such Bourns® custom products.

Users shall not sell, transfer, export or re-export any Bourns® products or technology for use in activities which involve the design, development, production, use or stockpiling of nuclear, chemical or biological weapons or missiles, nor shall they use Bourns® products or technology in any facility which engages in activities relating to such devices. The foregoing restrictions apply to all uses and applications that violate national or international prohibitions, including embargos or international regulations. Further, Bourns® products and Bourns technology and technical data may not under any circumstance be exported or re-exported to countries subject to international sanctions or embargoes. Bourns® products may not, without prior authorization from Bourns and/or the U.S. Government, be resold, transferred, or re-exported to any party not eligible to receive U.S. commodities, software, and technical data.

To the maximum extent permitted by applicable law, Bourns disclaims (i) any and all liability for special, punitive, consequential, incidental or indirect damages or lost revenues or lost profits, and (ii) any and all implied warranties, including implied warranties of fitness for particular purpose, non-infringement and merchantability.

For your convenience, copies of this Legal Disclaimer Notice with German, Spanish, Japanese, Traditional Chinese and Simplified Chinese bilingual versions are available at:

Web Page: <http://www.bourns.com/legal/disclaimers-terms-and-policies>

PDF: <http://www.bourns.com/docs/Legal/disclaimer.pdf>