



AMP CT

TE Internal #: 179228-5

AMP CT, Housing, Receptacle, Wire-to-Wire / Wire-to-Board, 5 Position, 2mm [.079in] Centerline, Crimp, 1 Row, Natural Housing Color, Wire & Cable

[View on TE.com >](#)

Connectors > PCB Connectors > Wire-to-Board Connectors > Wire-to-Board Connector Assemblies & Housings >

AMP COMMON TERMINATION HOUSINGS

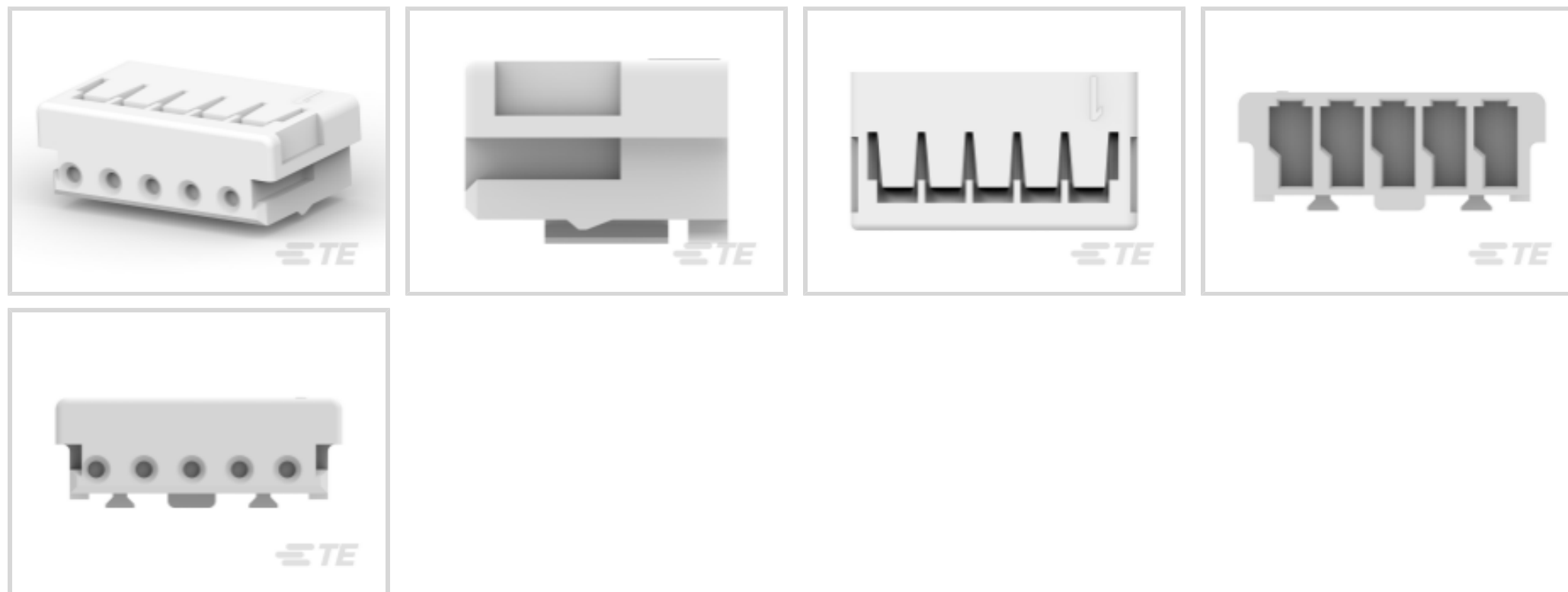

Connector Product Type: **Housing**

Connector & Housing Type: **Receptacle**

Connector System: **Wire-to-Board, Wire-to-Wire**

Number of Positions: **5**

Centerline (Pitch): **2 mm [.079 in]**

[All AMP COMMON TERMINATION HOUSINGS \(149\)](#)

Features

Product Type Features

Connector Product Type	Housing
Connector & Housing Type	Receptacle
Connector System	Wire-to-Board, Wire-to-Wire
Sealable	No
Connector & Contact Terminates To	Wire & Cable

Configuration Features

Number of Positions	5
Number of Rows	1

Electrical Characteristics

Dielectric Withstanding Voltage (Max)	2000 VAC
Insulation Resistance	1000 MΩ
Operating Voltage	125 VAC



Contact Features

Contact Layout	Inline
Contact Type	Socket
Contact Current Rating (Max)	4 A

Termination Features

Termination Method to Wire & Cable	Crimp
------------------------------------	-------

Mechanical Attachment

Strain Relief	Without
Panel Mount Feature	Without
PCB Mount Retention	Without
Mating Retention	Without
Connector Mounting Type	Cable Mount (Free-Hanging)

Housing Features

Housing Material	Thermoplastic
Centerline (Pitch)	2 mm [.079 in]
Housing Color	Natural

Dimensions

Connector Length	12 mm [.472 in]
Connector Height	6.6 mm [.26 in]
Connector Width	4.6 mm [.181 in]
Wire Size	30 – 22 AWG

Usage Conditions

Operating Temperature Range	-30 – 105 °C [-22 – 221 °F]
-----------------------------	-----------------------------

Operation/Application

Circuit Application	Power & Signal
---------------------	----------------

Industry Standards

Glow Wire Rating	Standard Part - Not Glow Wire
UL Flammability Rating	UL 94V-0
UL File Number	E28476
Agency/Standard	CSA, UL
CSA File Number	LR 7189



Packaging Features

Packaging Quantity	3000
Packaging Method	Bag/Box

Product Compliance

[For compliance documentation, visit the product page on TE.com>](#)

EU RoHS Directive 2011/65/EU	Compliant
EU ELV Directive 2000/53/EC	Compliant
China RoHS 2 Directive MIIT Order No 32, 2016	No Restricted Materials Above Threshold
EU REACH Regulation (EC) No. 1907/2006	Current ECHA Candidate List: JAN 2021 (211) Candidate List Declared Against: JAN 2021 (211) Does not contain REACH SVHC
Halogen Content	Low Halogen - Br, Cl, F, I < 900 ppm per homogenous material. Also BFR/CFR/PVC Free
Solder Process Capability	Not applicable for solder process capability

Product Compliance Disclaimer

This information is provided based on reasonable inquiry of our suppliers and represents our current actual knowledge based on the information they provided. This information is subject to change. The part numbers that TE has identified as EU RoHS compliant have a maximum concentration of 0.1% by weight in homogenous materials for lead, hexavalent chromium, mercury, PBB, PBDE, DBP, BBP, DEHP, DIBP, and 0.01% for cadmium, or qualify for an exemption to these limits as defined in the Annexes of Directive 2011/65/EU (RoHS2). Finished electrical and electronic equipment products will be CE marked as required by Directive 2011/65/EU. Components may not be CE marked. Additionally, the part numbers that TE has identified as EU ELV compliant have a maximum concentration of 0.1% by weight in homogenous materials for lead, hexavalent chromium, and mercury, and 0.01% for cadmium, or qualify for an exemption to these limits as defined in the Annexes of Directive 2000/53/EC (ELV). Regarding the REACH Regulation, the information TE provides on SVHC in articles for this part number is based on the latest European Chemicals Agency (ECHA) 'Guidance on requirements for substances in articles' posted at this URL: <https://echa.europa.eu/guidance-documents/guidance-on-reach>

Compatible Parts



TE Part # CAT-AM7017-C7671
AMP COMMON TERMINATION CONTACTS



TE Part # CAT-AM7017-H342
AMP COMMON TERMINATION HEADERS



TE Part # CAT-3984552-PHITPS
CT Post Header Assembly: Part. Shrouded



TE Part # CAT-3984552-BHTHVS
CT Box Header SMT: Vert, Shrouded



TE Part # CAT-3980408-PHDBXV
CT 2mm Post Header Assembly: Box-V



TE Part # 292134-5
CT BOX HDR ASSY V 5P AU W/KINK



TE Part # CAT-3980407-RHDRRA
CT 2mm Header Assembly: Right Angle



TE Part # CAT-3980655-RHAFH
CT Relay Header Assembly: Free Hanging



TE Part # 292164-5
CT P/HDR BOX H ASSY 5P T/P NAT



TE Part # 292165-5
CT P/HDR BOX V 5P T/P NAT



TE Part # 292166-5
CT P/HDR BOX V 5P T/P NAT W/O

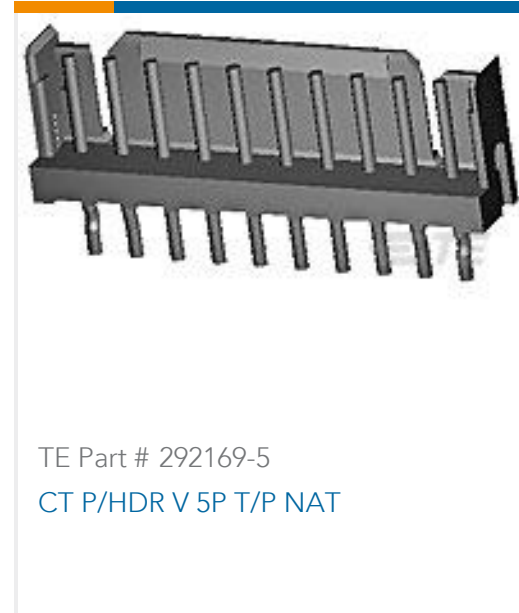

TE Part # 292169-5
CT P/HDR V 5P T/P NAT



TE Part # 292170-5
CT P/HDR ASSY 5P V W/O KINK T



TE Part # 292271-5
MT REC ASSY AU-PL. 5P GRAY

Also in the Series | AMP CT



PCB Connector Mounting(46)

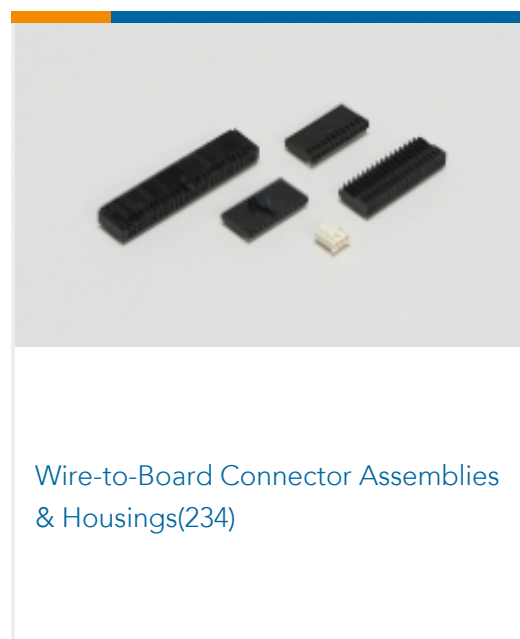

Wire-to-Board Connector Assemblies & Housings(234)

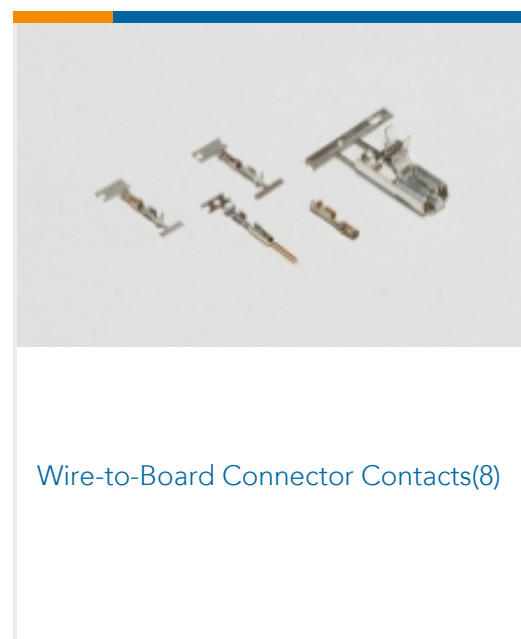

Wire-to-Board Connector Contacts(8)



Wire-to-Board Headers & Receptacles (760)

Customers Also Bought



TE Part #1-292254-1
AMP COMMON TERMINATION HEADERS



TE Part #1-353908-5
Mini Common Termination (CT) Housings



TE Part #1-353293-3
MINI CT MT REC ASSY 13P GRAY



TE Part #172074-1
187 HSG. PLMKII REC. NAT

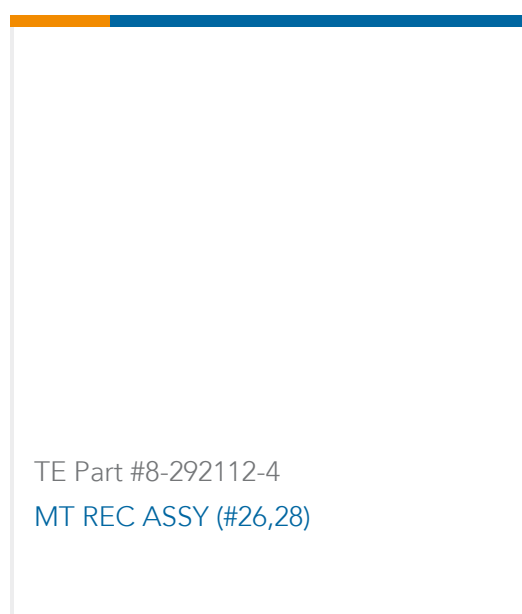
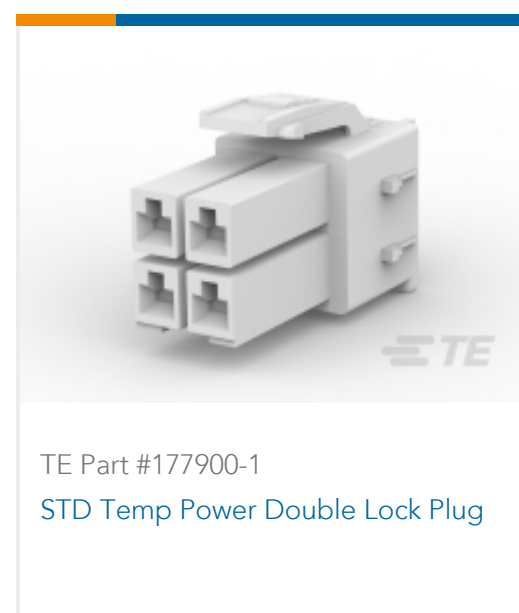
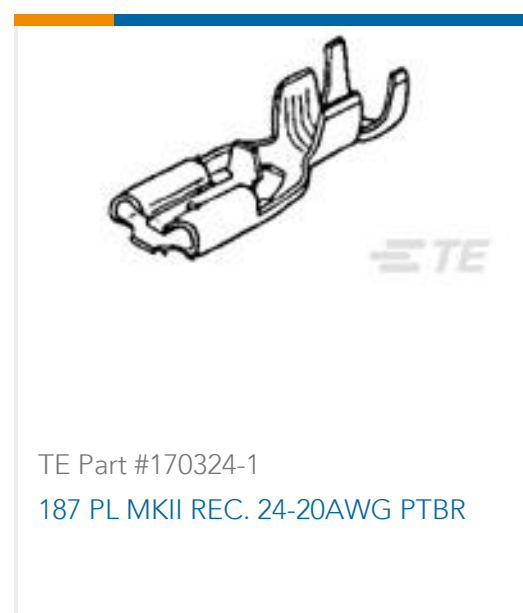

Documents

Product Drawings

[CT CRIMP TYPE REC HSG](#)

English

CAD Files

[3D PDF](#)

3D

Customer View Model

[ENG_CVM_CVM_179228-5_N1.2d_dxf.zip](#)

English

Customer View Model

[ENG_CVM_CVM_179228-5_N1.3d_igs.zip](#)

English

Customer View Model

[ENG_CVM_CVM_179228-5_N1.3d_stp.zip](#)

English

By downloading the CAD file I accept and agree to the [Terms and Conditions](#) of use.

Datasheets & Catalog Pages

[POWER_CONNECTORS_CATALOG_SEC02_CABLE_MOUNTED](#)

English

[2.0MM_AMP_CT_CONNECTOR_SERIES_QUICK_REF_GUIDE](#)

English

Product Specifications

[Crimping of AMP 2.0mm Pitch, CT Crimp Typell Rec Contact](#)

English



Application Specification

English

Product Environmental Compliance

[MD_179228-5_032020181247_dmtec](#)

English

[MD_179228-5_032020181247_dmtec](#)

English

Agency Approvals

[Agency Approval Document](#)

English