

## General Purpose Diecast Aluminium Enclosure 90 x 38 x 30mm



### DESCRIPTION

An aluminium diecast box with a natural finish that is easily machined and finished.

### DISTINCTIVE FEATURES

- Close fitting flanged lid secured by screws supplied offer excellent screening properties to the box
- Light weight and easy to machine
- Smooth natural finish

### APPLICATIONS

Ideal for projects involving heat as the case itself makes an excellent heat sink. Flanged lid provides excellent RFI shielding so is suitable for applications where EMC shielding is required. The enclosure is tough and robust, so ideal for guitar effects pedals. Suitable for use as an instrument case, meter case or junction box.

**ADC-12**  
Aluminium

⊕  
**Screws**

**IP40**





## GENERAL SPECIFICATION

Series	General Purpose Diecast Aluminium Enclosures
Internal Features	Flanged Lid



## MATERIALS

Material	ADC-12 Aluminium
Finish	Smooth
Colour	Natural
Screws	Qty 4 ⊕ #6-32 x 1/2in
Weight	72g



## ENVIRONMENTAL/OPERATING SPECIFICATION

Operating Temperature	40°C to +120°C
Ingress Protection (IP Rating)	At least IP40



## DIMENSIONS/DRAWINGS

Dimensions	mm
------------	----

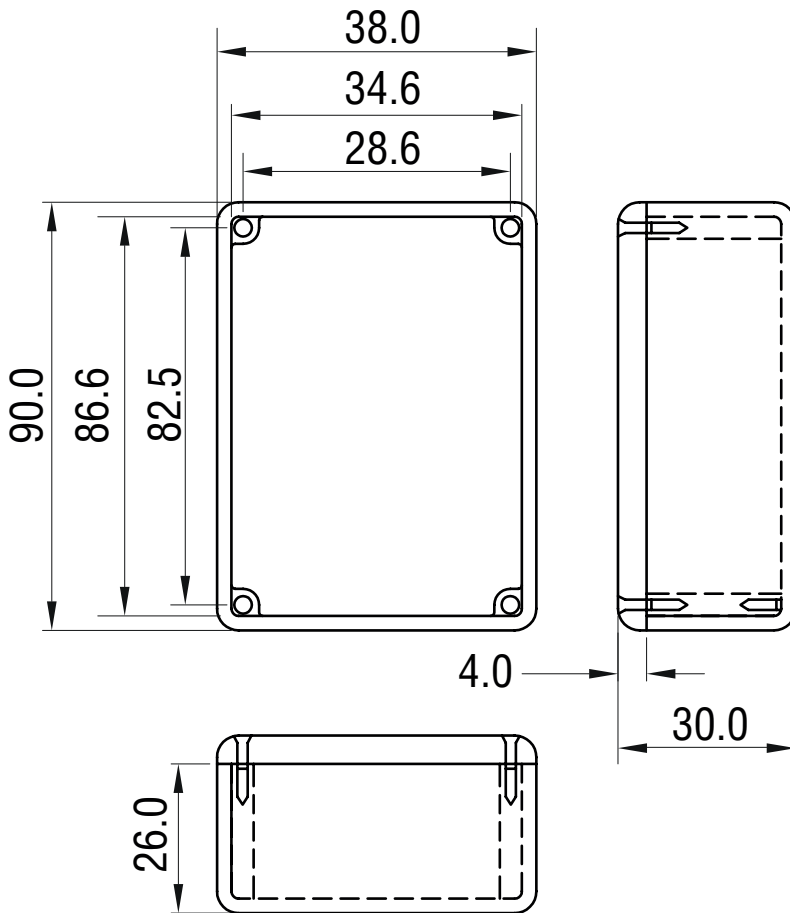

## PART NUMBER TABLE

Part Number	EAN	UNSPSC	Country of Origin
30-4236	5053556001668	39121324	Taiwan

# R-TECH

Tried & trusted technology

**Important Notice:** This data sheet and its contents (the "Information") belong to Rapid Electronics Limited or are licensed to it. No licence is granted for the use of it other than for information purposes in connection with the products to which it relates. No licence of any intellectual property rights is granted. The Information is subject to change without notice and replaces all data sheets previously supplied. The Information supplied is believed to be accurate but Rapid Electronics Limited assumes no responsibility for its accuracy or completeness, any error in or omission from it or for any use made of it. Users of this data sheet should check for themselves the Information and the suitability of the products for their purpose and not make any assumptions based on information included or omitted. Liability for loss or damage resulting from any reliance on the Information or use of it (including liability resulting from negligence or where Rapid Electronics Limited were aware of the possibility of such loss or damage arising) is excluded. This will not operate to limit or restrict Rapid Electronics Limited's liability for death or personal injury resulting from its negligence.