

EVW016

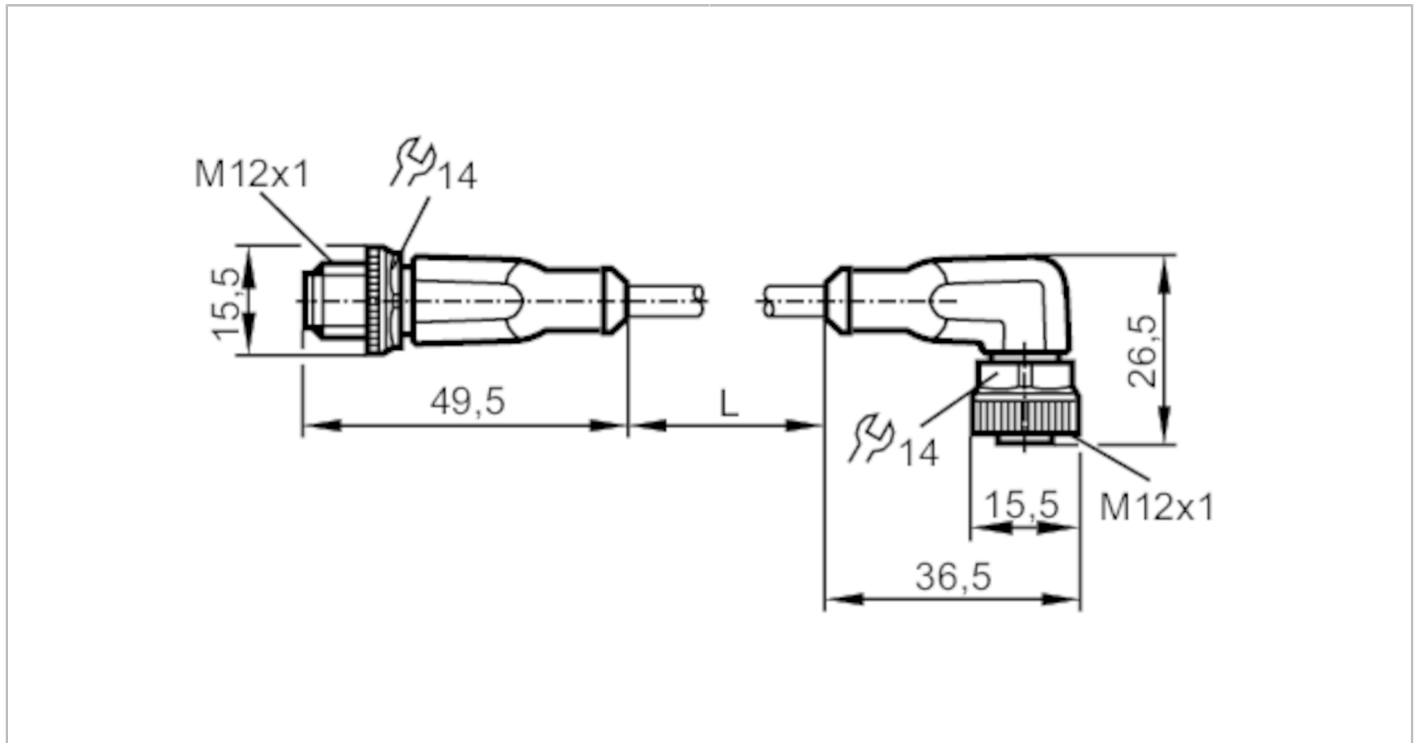

Connection cable

VDOAH040SCS0006T04STGH040SCS



Application	
Special feature	Free from silicone; Halogen-free; Gold-plated contacts; Drag chain suitability
Application	welding applications
Free from silicone	yes
Electrical data	
Operating voltage [V]	< 250 AC / < 300 DC
Protection class	II
Max. current load total [A]	4
Operating conditions	
Ambient temperature [°C]	-25...90
Note on ambient temperature	cULus: ...75
Ambient temperature (moving) [°C]	-25...90
Note on ambient temperature (moving)	cULus: ...75
Protection	IP 65; IP 67; IP 68; IP 69K

EVW016



Connection cable

VDOAH040SCS0006T04STGH040SCS

Mechanical data		
Weight [g]	221.2	
Materials	housing: TPU orange; Sealing: FKM	
Material nut	brass, anti-spatter / brass, anti-spatter	
Drag chain suitability	yes	
Drag chain suitability	bending radius for flexible use	min. 10 x cable diameter
	travel speed	max. 3.3 m/s for a horizontal travel length of 5 m and max. acceleration of 5 m/s ²
	bending cycles	> 2 Mio.
	torsional strain	± 180 °/m

Remarks	
Remarks	with 2 label holders 30 mm long
Pack quantity	1 pcs.

Electrical connection - plug

Connector: 1 x M12, straight; Locking: brass, anti-spatter; Contacts: gold-plated; Tightening torque: 0.6...1.5 Nm



Electrical connection

Cable: 6 m, PUR, Halogen-free, grey, Ø 4.9 mm; not irradiated (can be recycled); resistant to welding sparks; 4 x 0.34 mm² (42 x Ø 0.1 mm)

Connection

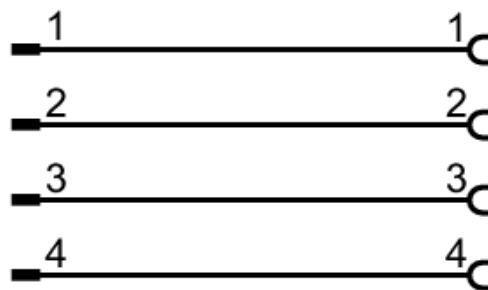

Electrical connection - socket

Connector: 1 x M12, angled; Locking: brass, anti-spatter; Contacts: gold-plated; Tightening torque: 0.6...1.5 Nm

EVW016



Connection cable

VDOAH040SCS0006T04STGH040SCS



Diagrams and graphs

characteristic line for derating



Derating $I_{max} * 0.8$ (DIN EN 60512-5-2)

X Ambient temperature [°C]

Y Current [A]