

M8 male 0° with cable

PUR 4x0.25 bk UL/CSA 2m

M8

Male straight

4-pole

Plastic housings with good resistance against chemicals and oils. The resistance to aggressive media should be individually tested for your application. Further details on request. Further cable lengths on request.

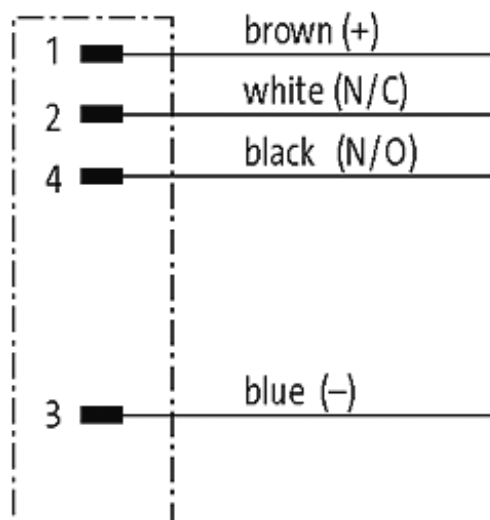
[Link to Product](#)**Illustration**

Male

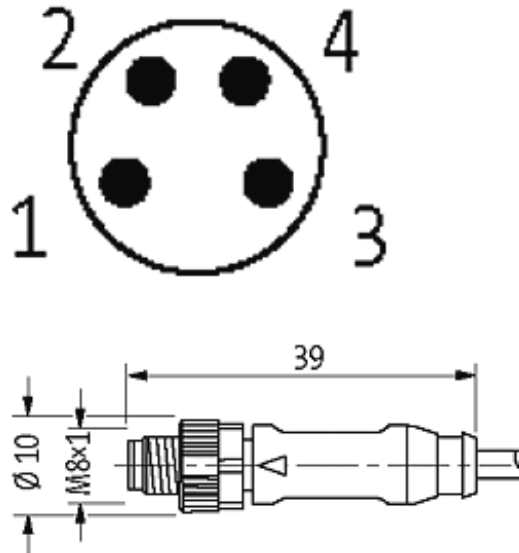

Product may differ from Image

Approvals



* only for products with UL/CSA approved cable

Form

08011

Technical Data

Operating voltage	max. 30 V AC/DC
Operating current per contact	max. 4 A
Locking of ports	Screw thread M8 × 1 mm (recommended torque 0.4 Nm) self-securing
Protection	IP67 inserted and tightened (EN 60529)

Cables

Cable number	621
No./diameter of wires	4 × 0.25 mm ²
Wire isolation	PVC (br, wh, bl, bk)
C-track properties	2 Mio.
Jacket Color	black
Shore hardness outer jacket	85 ± 5A

The information in this brochure has been compiled with the utmost care.

Liability for the correctness completeness and topicality of the information is restricted to gross negligence. Version: 05/15

Murrelektronik GmbH | Falkenstraße 3, 71570 Oppenweiler | Fon +49 (71 91) 47-0, Fax +49 (71 91) 47-491000 | shop@murrelektronik.de | shop.murrelektronik.de

Material (jacket)	PUR/PVC (UL/CSA)
Outer diameter	approx. 4.8 mm
Bend radius (fixed)	10 × outer Ø
Bend radius (moving)	15 × outer Ø
Temperature range (fixed)	-30...+80 °C
Temperature range (mobile)	-5...+80 °C
Commercial data	
country of origin	DE
customs tariff number	85444290
minimum order quantity	1