



CONT. F. RAILW. A., AC-3, 5.5KW 400V, DC 110V, 0,7...1,25*US, VARISTOR INTEGRATED, 3POL,SZ S00, STANDING BUILT-IN SPRING-LOADED TERMINAL

Figure similar

product brand name		SIRIUS
Product designation		Coupling relay

General technical data:

Insulation voltage		
<ul style="list-style-type: none"> Rated value 	V	690
Degree of pollution		3
Surge voltage resistance Rated value	kV	6
Mechanical service life (switching cycles)		
<ul style="list-style-type: none"> of the contactor typical of the contactor with added electronics-compatible auxiliary switch block typical of the contactor with added auxiliary switch block typical 		30 000 000 5 000 000 10 000 000
Thermal short-time current restricted to 10 s	A	90
Protection class IP		
<ul style="list-style-type: none"> on the front of the terminal 		IP20 IP20
Equipment marking		
<ul style="list-style-type: none"> acc. to DIN EN 61346-2 acc. to DIN EN 81346-2 		Q Q

Main circuit:

Number of poles for main current circuit		3
Number of NC contacts for main contacts		0
Number of NO contacts for main contacts		3
Operating voltage		

• at AC-3 Rated value maximum	V	690
Operating current		
• at AC-1		
— at 400 V at ambient temperature 40 °C Rated value	A	22
— up to 690 V at ambient temperature 40 °C Rated value	A	22
— up to 690 V at ambient temperature 60 °C Rated value	A	20
• at AC-2 at 400 V Rated value	A	12
• at AC-3		
— at 400 V Rated value	A	12
— at 500 V Rated value	A	9.2
— at 690 V Rated value	A	6.7
• at AC-4 at 400 V Rated value	A	8.5
Operating current with 1 current path		
• at DC-1		
— at 24 V Rated value	A	20
— at 110 V Rated value	A	2.1
— at 220 V Rated value	A	0.8
— at 440 V Rated value	A	0.6
— at 600 V Rated value	A	0.6
• at DC-3 at DC-5		
— at 24 V Rated value	A	20
— at 110 V Rated value	A	0.1
Operating current with 2 current paths in series		
• at DC-1		
— at 24 V Rated value	A	20
— at 110 V Rated value	A	12
— at 220 V Rated value	A	1.6
— at 440 V Rated value	A	0.8
— at 600 V Rated value	A	0.7
• at DC-3 at DC-5		
— at 110 V Rated value	A	0.35
— at 24 V Rated value	A	20
Operating current with 3 current paths in series		
• at DC-1		
— at 24 V Rated value	A	20
— at 110 V Rated value	A	20
— at 220 V Rated value	A	20
— at 440 V Rated value	A	1.3
— at 600 V Rated value	A	1

<ul style="list-style-type: none"> • at DC-3 at DC-5 <ul style="list-style-type: none"> — at 110 V Rated value — at 220 V Rated value — at 24 V Rated value — at 440 V Rated value — at 600 V Rated value 	A	20
	A	1.5
	A	20
	A	0.2
	A	0.2
Operating power		
<ul style="list-style-type: none"> • at AC-1 at 400 V Rated value • at AC-2 at 400 V Rated value • at AC-4 at 400 V Rated value 	kW	13
	kW	5.5
	kW	4
Operating power		
<ul style="list-style-type: none"> • at AC-1 <ul style="list-style-type: none"> — at 230 V at 60 °C Rated value — at 230 V Rated value — at 400 V at 60 °C Rated value — at 690 V at 60 °C Rated value — at 690 V Rated value • at AC-3 <ul style="list-style-type: none"> — at 230 V Rated value — at 400 V Rated value — at 690 V Rated value 	kW	7.5
	kW	7.5
	kW	13
	kW	22
	kW	22
	kW	3
	kW	5.5
	kW	5.5
Operating power for ≥ 200000 operating cycles at AC-4		
<ul style="list-style-type: none"> • at 400 V Rated value • at 690 V Rated value 	kW	2
	kW	2.5
Operating frequency		
<ul style="list-style-type: none"> • at AC-3 maximum 	1/h	750

Control circuit/ Control:

Type of voltage of the control supply voltage		DC
Control supply voltage for DC		
<ul style="list-style-type: none"> • Rated value 	V	110
Operating range factor control supply voltage rated value of the magnet coil for DC		0.7 ... 1.25
Design of the surge suppressor		with varistor
Closing power of the magnet coil for DC	W	13
Holding power of the magnet coil for DC	W	4

Auxiliary circuit:

Number of NC contacts		
<ul style="list-style-type: none"> • for auxiliary contacts <ul style="list-style-type: none"> — instantaneous contact 		0
Number of NO contacts		

<ul style="list-style-type: none"> • for auxiliary contacts <ul style="list-style-type: none"> — instantaneous contact 		0
Product expansion Auxiliary switch		Yes
Operating current at AC-15		
<ul style="list-style-type: none"> • at 230 V Rated value 	A	10
<ul style="list-style-type: none"> • at 400 V Rated value 	A	3
<ul style="list-style-type: none"> • at 690 V Rated value 	A	1
Operating current		
<ul style="list-style-type: none"> • at DC-12 at 125 V Rated value 	A	2
<ul style="list-style-type: none"> • at DC-12 at 220 V Rated value 	A	1
<ul style="list-style-type: none"> • at DC-12 at 600 V Rated value 	A	0.15
<ul style="list-style-type: none"> • at DC-13 at 125 V Rated value 	A	0.9
<ul style="list-style-type: none"> • at DC-13 at 220 V Rated value 	A	0.3
<ul style="list-style-type: none"> • at DC-13 at 600 V Rated value 	A	0.1
Operating current		
<ul style="list-style-type: none"> • at DC-12 <ul style="list-style-type: none"> — at 60 V Rated value — at 110 V Rated value 	A	6
	A	3
<ul style="list-style-type: none"> • at DC-13 <ul style="list-style-type: none"> — at 24 V Rated value — at 60 V Rated value — at 110 V Rated value 	A	10
	A	2
	A	1
Contact reliability of the auxiliary contacts		1 faulty switching per 100 million (17 V, 1 mA)

UL/CSA ratings:

Full-load current (FLA) for three-phase AC motor		
<ul style="list-style-type: none"> • at 480 V Rated value 	A	11
<ul style="list-style-type: none"> • at 600 V Rated value 	A	11
yielded mechanical performance [hp]		
<ul style="list-style-type: none"> • for single-phase AC motor at 110/120 V Rated value 	metric hp	0.5
<ul style="list-style-type: none"> • for single-phase AC motor at 230 V Rated value 	metric hp	2
<ul style="list-style-type: none"> • for three-phase AC motor at 200/208 V Rated value 	metric hp	3
<ul style="list-style-type: none"> • for three-phase AC motor at 220/230 V Rated value 	metric hp	3
<ul style="list-style-type: none"> • for three-phase AC motor at 460/480 V Rated value 	metric hp	7.5
<ul style="list-style-type: none"> • for three-phase AC motor at 575/600 V Rated value 	metric hp	10
Contact rating of the auxiliary contacts acc. to UL		A600 / Q600

Short-circuit:

Design of the fuse link		
<ul style="list-style-type: none"> • for short-circuit protection of the main circuit <ul style="list-style-type: none"> — with type of assignment 1 required — with type of assignment 2 required • for short-circuit protection of the auxiliary switch required 		gL/gG LV HRC 3NA, DIAZED 5SB, NEOZED 5SE: 35 A gL/gG LV HRC 3NA, DIAZED 5SB, NEOZED 5SE: 20 A fuse gL/gG: 10 A

Installation/ mounting/ dimensions:

mounting position		standing, on horizontal mounting surface
Mounting type		screw and snap-on mounting onto 35 mm standard mounting rail according to DIN EN 50022
<ul style="list-style-type: none"> • Side-by-side mounting 		Yes
Height	mm	69.5
Width	mm	45
Depth	mm	121
Required spacing		
<ul style="list-style-type: none"> • with side-by-side mounting <ul style="list-style-type: none"> — forwards — Backwards — upwards — downwards — at the side • for grounded parts <ul style="list-style-type: none"> — forwards — Backwards — upwards — at the side — downwards • for live parts <ul style="list-style-type: none"> — forwards — Backwards — upwards — downwards — at the side 	mm	0 0 0 0 0 0 0 0 6 0 0 0 0 0 6

Connections/ Terminals:

Type of electrical connection		
<ul style="list-style-type: none"> • for main current circuit • for auxiliary and control current circuit 		spring-loaded terminals spring-loaded terminals
Type of connectable conductor cross-section		
<ul style="list-style-type: none"> • for main contacts <ul style="list-style-type: none"> — single or multi-stranded 		2x (0,5 ... 4 mm ²)

— finely stranded with core end processing	2x (0.5 ... 2.5 mm ²)
— finely stranded without core end processing	2x (0.5 ... 2.5 mm ²)
• for AWG conductors for main contacts	2x (20 ... 12)
• for auxiliary contacts	
— single or multi-stranded	2x (0,5 ... 4 mm ²)
— finely stranded with core end processing	2x (0.5 ... 2.5 mm ²)
— finely stranded without core end processing	2x (0.5 ... 2.5 mm ²)
• for AWG conductors for auxiliary contacts	2x (20 ... 12)

Safety related data:

B10 value with high demand rate acc. to SN 31920		1 000 000
Proportion of dangerous failures		
• with low demand rate acc. to SN 31920	%	40
• with high demand rate acc. to SN 31920	%	73
Failure rate [FIT] with low demand rate acc. to SN 31920	FIT	100
Product function Mirror contact acc. to IEC 60947-4-1		Yes
T1 value for proof test interval or service life acc. to IEC 61508	y	20
Protection against electrical shock		finger-safe



Mechanical data:

Size of contactor		S00
--------------------------	--	-----



Ambient conditions:

Installation altitude at height above sea level maximum	m	2 000
Ambient temperature		
• during operation	°C	-40 ... +70
• during operation Note		Railway application: See catalog for rated conditions
• during storage	°C	-55 ... +80

Certificates/ approvals:

General Product Approval			Declaration of Conformity	Test Certificates	Shipping Approval
 CCC	 CSA		 EG-Konf.	Special Test Certificate	 ABS

Shipping Approval					
 BUREAU VERITAS	 DNV	 GL	 LRS	 PRS	 RINA

Shipping Approval	other
 RMRS	Environmental Confirmations  VDE

Further information

Information- and Downloadcenter (Catalogs, Brochures,...)

<http://www.siemens.com/industrial-controls/catalogs>

Industry Mall (Online ordering system)

<http://www.siemens.com/industrymall>

Cax online generator

<http://support.automation.siemens.com/WW/CAXorder/default.aspx?lang=en&mfb=3RT20172LF421LA0>

Service&Support (Manuals, Certificates, Characteristics, FAQs,...)

<http://support.automation.siemens.com/WW/view/en/3RT20172LF421LA0/all>

Image database (product images, 2D dimension drawings, 3D models, device circuit diagrams, EPLAN macros, ...)

http://www.automation.siemens.com/bilddb/cax_de.aspx?mfb=3RT20172LF421LA0&lang=en

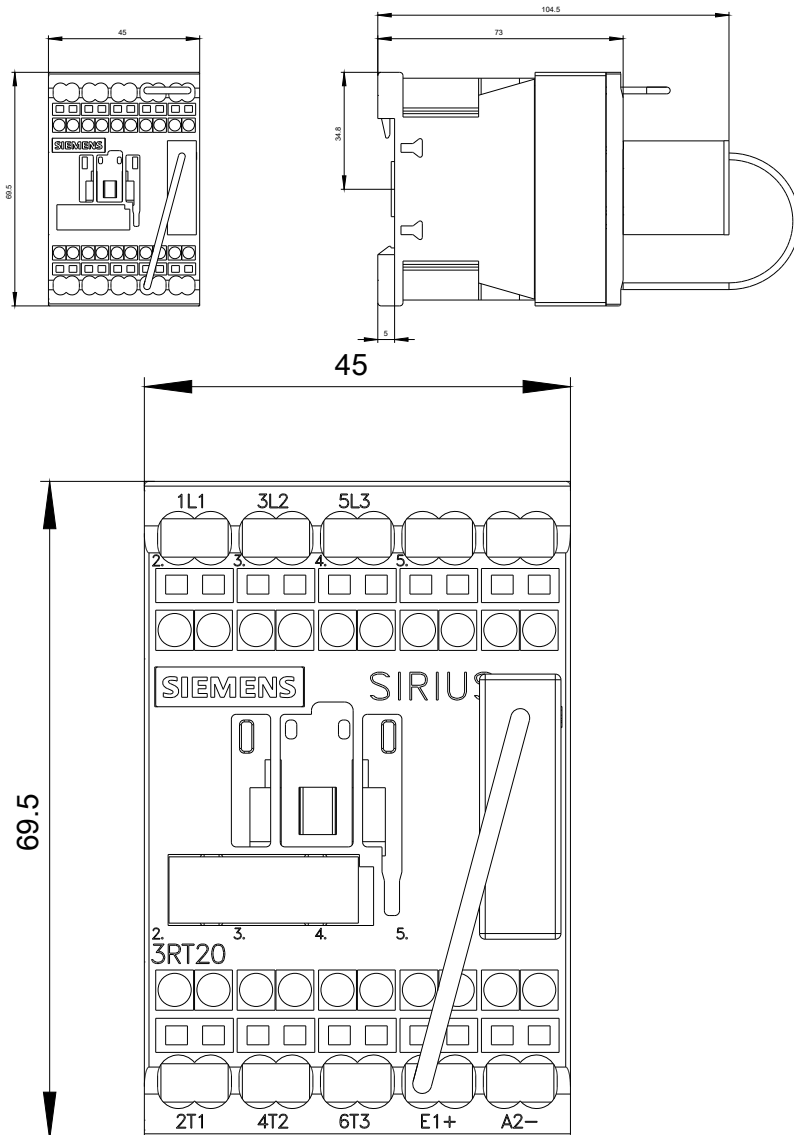

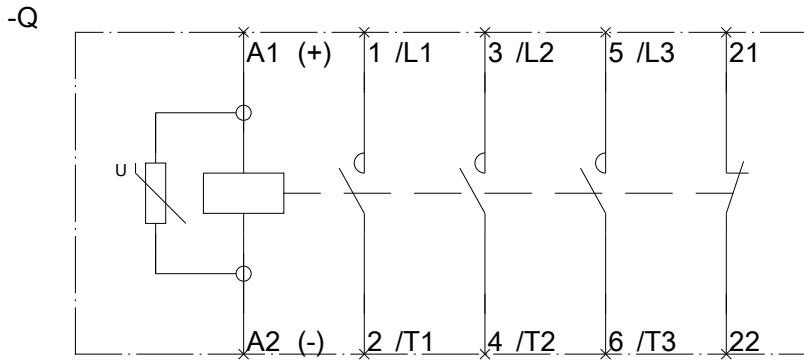

last modified:

11.03.2015