

RKTS

Aktor-/Sensor-Anschlussleitung, M12-Kupplung mit Schraubverschluss und angespritztem Kabel, Abschirmung über die Rändelmutter geleitet

Actuator/sensor cordset, single-ended, M12 female connector with threaded joint and molded cable, shielding connected to knurled nut

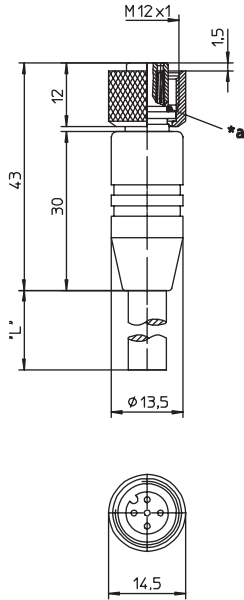

*a O-Ring
O-ring

RKWTB

Aktor-/Sensor-Anschlussleitung, M12-Winkelkupplung mit Schraubverschluss und angespritztem Kabel, Abschirmung über die Rändelmutter geleitet

Actuator/sensor cordset, single-ended, M12 female right angle connector with threaded joint and molded cable, shielding connected to knurled nut

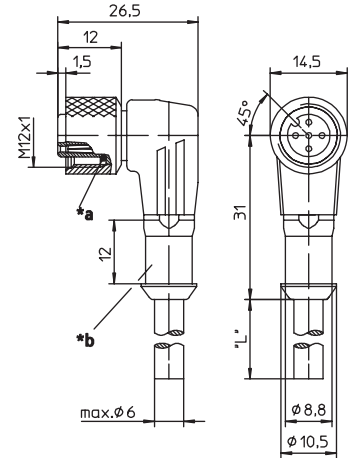

8-polige Ausführung / 8 pole version

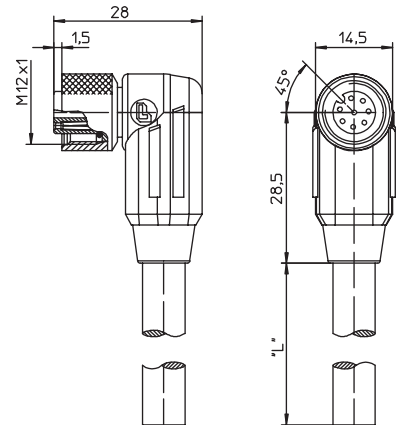

*a O-Ring
O-ring

*b Schutzschlauchmontage
hose mounting

Pinbelegung Pin assignment

4-polig 4 poles



- 1 = braun / brown
- 2 = weiß / white
- 3 = blau / blue
- 4 = schwarz / black

5-polig 5 poles



- 1 = braun / brown
- 2 = weiß / white
- 3 = blau / blue
- 4 = schwarz / black
- 5 = grau / grey















8-polig 8 poles



- 1 = weiß / white
- 2 = braun / brown
- 3 = grün / green
- 4 = gelb / yellow
- 5 = grau / grey
- 6 = rosa / pink
- 7 = blau / blue
- 8 = rot / red

Anschlussleitungen für Aktoren, Sensoren und Verteiler Cordsets, single-ended, for actuators, sensors and distribution boxes

Technische Daten		Technical data	
Umgebungstemperatur	-25°C / +80°C	Operating temperature range	-25°C / +80°C
Werkstoffe		Materials	
Gehäuse / Griffkörper	TPU	Housing / Molded body	TPU
Kontaktträger	PBT	Insert	PBT
Kontakt	CuZn, unternickelt und 0,8 µm vergoldet	Contact	CuZn, pre-nickeled and 0.8 microns gold-plated
Gewindebuchse / Rändelschraube/-mutter / Sechskantschraube/-mutter / Hülse	CuZn, vernickelt	Receptacle shell / knurled screw/nut / hexagon screw/nut / sleeve	CuZn, nickel-plated
Schirmhülse	CuZn, verzinkt	Shield sleeve	CuZn, tin-plated
O-Ring	FKM	O-ring	FKM
Mechanische Daten		Mechanical data	
Schutzart	IP 67 Nur im verschraubten Zustand mit den dazugehörigen Gegenstücken.	Degree of protection	IP 67 Only in locked position with its proper counterparts.
Elektrische Daten		Electrical data	
Durchgangswiderstand	≤ 5 mΩ	Contact resistance	≤ 5 mΩ
Nennstrom bei 40°C	4 A	Nominal current at 40°C	4 A
Nennspannung	4-polig 240 V 5-polig 60 V 8-polig 30 V	Nominal voltage	4 poles 240 V 5 poles 60 V 8 poles 30 V
Bemessungsspannung	3- bis 4-polig 250 V 5-polig 63 V 8-polig 36 V	Rated voltage	3-4 poles 250 V 5 poles 63 V 8 poles 36 V
Prüfspannung	3- bis 4-polig 2,0 kV eff. / 60 s 5- bis 8-polig 1,5 kV eff. / 60 s	Test voltage	3-4 poles 2.0 kV eff. / 60 s 5-8 poles 1.5 kV eff. / 60 s
Isolationswiderstand	> 10 ⁹ Ω	Insulation resistance	> 10 ⁹ Ω
Verschmutzungsgrad	3	Pollution degree	3

Bestellbezeichnung Designation		Polzahl Poles	Mantel Outer jacket	
RKTS 4-182/... M	RKWTH 4-182/... M	4	PVC	
RKTS 4-288/... M	RKWTH 4-288/... M		PUR halogenfrei / halogen free	   
RKTS 5-183/... M		5	PVC	
RKTS 5-298/... M	RKWTH 5-298/... M		PUR halogenfrei / halogen free	   
RKTS 8-184/... M		8	PVC	
RKTS 8-299/... M	RKWTH 8-299/... M		PUR halogenfrei / halogen free	   

Standardlängen: 2 M / 5 M / 10 M
Andere Kabellängen oder Leitungsaufbauten auf Anfrage.

Standard lengths: 2 M / 5 M / 10 M
Other cable lengths or cable specifications on request.