

COMPACT PC BOARD POWER RELAY

JW RELAYS

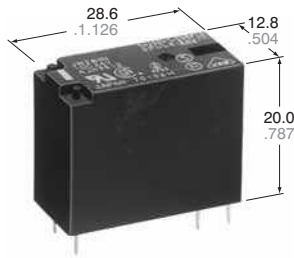

mm inch

FEATURES

- **Miniature package with universal terminal footprint**
- **High dielectric withstanding for transient protection:**
10,000 V surge in μ s between coil and contact
- **Sealed construction**
- **Class B coil insulation types available**
- **TV rated (TV-5) types available (only for 1 Form A type)**
- **VDE, TÜV, SEMKO, SEV, FIMKO, TV-5 also approved**

About Cd-free contacts

We have introduced cadmium-free type products to reduce environmentally hazardous substances. Please replace parts that contain cadmium with Cd-free products. Evaluate them with your actual application before use because the life of a relay depends on the contact material and load.

Note: Add the suffix "F" to the part number for the 1 Form A contact type. The 1 Form C, 2 Form A and 2 Form C contact types were originally Cd-free, hence the suffix "F" is not required.

SPECIFICATIONS

Contact

		Standard type	High capacity type
Arrangement		1 Form A, 1 Form C, 2 Form A, 2 Form C	1 Form A, 1 Form C
Initial contact resistance, max. (By voltage drop 6 V DC 1 A)		100 m Ω	
Contact material		1a: AgSnO ₂ type 1c, 2a, 2c: AgNi type	
Rating (resistive load)	Nominal switching capacity	5 A 250 V AC, 5 A 30 V DC	10 A 250 V AC, 10 A 30 V DC
	Max. switching power	1,250 VA, 150 W	2,500 VA, 300 W
	Max. switching voltage	250 V AC, 30 V DC	
	Max. switching current	5 A	10 A
	Min. switching capacity ^{#1}	100 mA, 5 V DC	
Expected life (min. ope.)	Mechanical (at 180 cpm)	5 \times 10 ⁶	
	Electrical (at 6 cpm) (Resistive load)	10 ⁵	

Coil

Nominal operating power	530 mW
-------------------------	--------

^{#1} This value can change due to the switching frequency, environmental conditions, and desired reliability level, therefore it is recommended to check this with the actual load.

Remarks

* Specifications will vary with foreign standards certification ratings.

^{#1} Detection current: 10mA

^{#2} Wave is standard shock voltage of $\pm 1.2 \times 50\mu$ s according to JEC-212-1981

^{#3} Excluding contact bounce time

^{#4} Half-wave pulse of sine wave: 11ms; detection time: 10 μ s

^{#5} Half-wave pulse of sine wave: 6ms

^{#6} Detection time: 10 μ s

^{#7} Refer to "6. Usage, Storage and Transport Conditions" in **AMBIENT ENVIRONMENT** section in **Relay Technical Information**.

^{#8} When using relays in a high ambient temperature, consider the pick-up voltage rise due to the high temperature (a rise of approx. 0.4% V for each 1°C 33.8°F with 20°C 68°F as a reference) and use a coil impressed voltage that is within the maximum allowable voltage range.

Characteristics

		Standard type	High capacity type
Max. operating speed (at rated load)		6 cpm	
Initial insulation resistance		Min. 1,000 M Ω at 500 V DC	
Initial breakdown voltage ^{*1}	Between open contacts	1,000 Vrms for 1 min.	
	Between contacts and coil	5,000 Vrms for 1 min.	
	Between contact sets	3,000 Vrms for 1 min. (2 Form A, 2 Form C)	
Initial surge voltage between contacts and coil ^{*2}		Min. 10,000 V	
Operate time ^{*3} (at nominal voltage)		Max. 15 ms	
Release time (without diode) ^{*3} (at nominal voltage)		Max. 5 ms	
Temperature rise (at 20°C) (at nominal voltage) (with nominal coil voltage and at nominal switching capacity)		1a: max. 45°C 1c, 2a, 2c: max. 55°C (resistance method)	1a: max. 45°C 1c: max. 55°C (resistance method)
Shock resistance	Functional ^{*4}	Min. 98 m/s ² {10 G}	
	Destructive ^{*5}	Min. 980 m/s ² {100 G}	
Vibration resistance	Functional ^{*6}	10 to 55 Hz at double amplitude of 1.6 mm	
	Destructive	10 to 55 Hz at double amplitude of 2.0 mm	
Conditions for operation, transport and storage ^{*7} (Not freezing and condensing at low temperature)	Ambient temp. ^{*8}	-40°C to +85°C -40°F to +185°F	
	Humidity	5 to 85% R.H.	
Unit weight		Approx. 13 g .46 oz	

TYPICAL APPLICATIONS

1. Home appliances
TV sets, VCR, Microwave ovens
2. Office machines
Photocopiers, Vending machines
3. Industrial equipment
NC machines, Robots, Temperature controllers

ORDERING INFORMATION

Ex. JW 1 F S N - B - DC5V -

Contact arrangement	Contact capacity	Protective construction	Pick-up voltage	Coil insulation class	Coil voltage	Contact material
1: 1 Form C 1a: 1 Form A 2: 2 Form C 2a: 2 Form A	Nil: Standard (5 A) F: High capacity (10 A)*	S: Sealed type	N: 70% of nominal voltage	Nil: Class E insulation B: Class B insulation	DC 5, 6, 9, 12, 18, 24, 48 V	F: AgSnO ₂ type (1a) Nil: AgNi type (1c, 2a, 2c)

- *Only for 1 Form A and 1 Form C type
UL/CSA, VDE, SEMKO, FIMKO, SEV approved type is standard.
Notes: 1. When ordering TV rated (TV-5) types, add suffix-TV (available only for 1 Form A type).
2. Standard packing: Carton: 100 pcs. Case: 500 pcs.
3. Please inquire about the previous products (Cadmium containing parts).

TYPES

Standard (5A) types

Contact arrangement	Coil voltage, V DC	Part No.	Contact arrangement	Coil voltage, V DC	Part No.
1 Form A	5	JW1aSN-DC5V-F	2 Form A	5	JW2aSN-DC5V
	6	JW1aSN-DC6V-F		6	JW2aSN-DC6V
	9	JW1aSN-DC9V-F		9	JW2aSN-DC9V
	12	JW1aSN-DC12V-F		12	JW2aSN-DC12V
	18	JW1aSN-DC18V-F		18	JW2aSN-DC18V
	24	JW1aSN-DC24V-F		24	JW2aSN-DC24V
1 Form C	48	JW1aSN-DC48V-F	48	JW2aSN-DC48V	
	5	JW1SN-DC5V	2 Form C	5	JW2SN-DC5V
	6	JW1SN-DC6V		6	JW2SN-DC6V
	9	JW1SN-DC9V		9	JW2SN-DC9V
	12	JW1SN-DC12V		12	JW2SN-DC12V
	18	JW1SN-DC18V		18	JW2SN-DC18V
24	JW1SN-DC24V	24		JW2SN-DC24V	
	48	JW1SN-DC48V	48	JW2SN-DC48V	

High capacity (10 A) types

Contact arrangement	Coil voltage, V DC	Part No.	Contact arrangement	Coil voltage, V DC	Part No.
1 Form A	5	JW1aFSN-DC5V-F	1 Form C	5	JW1FSN-DC5V
	6	JW1aFSN-DC6V-F		6	JW1FSN-DC6V
	9	JW1aFSN-DC9V-F		9	JW1FSN-DC9V
	12	JW1aFSN-DC12V-F		12	JW1FSN-DC12V
	18	JW1aFSN-DC18V-F		18	JW1FSN-DC18V
	24	JW1aFSN-DC24V-F		24	JW1FSN-DC24V
	48	JW1aFSN-DC48V-F	48	JW1FSN-DC48V	

COIL DATA (at 20°C 68°F)

Nominal voltage, V DC	Pick-up voltage, V DC (max.) (Initial)	Drop-out voltage, V DC (min.) (Initial)	Nominal operating current, mA (±10%)	Coil resistance, W (±10%)	Nominal operating power, mW	Max. allowable voltage
5	3.5	0.5	106	47	530	130% V of Nominal Voltage (at 60°C 140°F) 120% V of Nominal Voltage (at 85°C 185°F)
6	4.2	0.6	88	68		
9	6.3	0.9	58	155		
12	8.4	1.2	44	270		
18	12.6	1.8	29	611		
24	16.8	2.4	22	1,100		
48	33.6	4.8	11	4,400		

DIMENSIONS(mm inch)

Download [CAD Data](#) from our Web site.

CAD Data 1 Form A

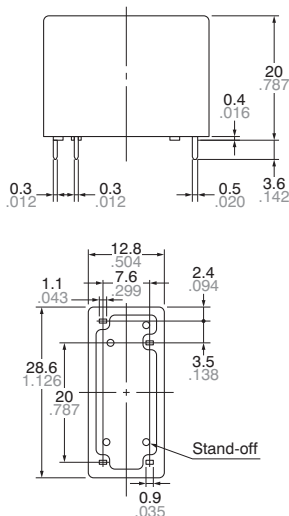

Dimension :
 Max. 1mm .039 inch
 1 to 3mm .039 to .118 inch
 Min. 3mm .118 inch

General tolerance
 $\pm 0.1 \pm .004$
 $\pm 0.2 \pm .008$
 $\pm 0.3 \pm .012$

PC board pattern
(Copper-side view)

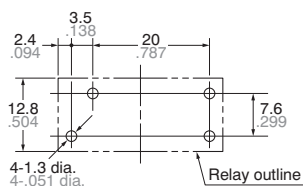

Tolerance: $\pm 0.1 \pm .004$
 Wiring diagram (Bottom view)

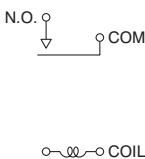

CAD Data 1 Form C

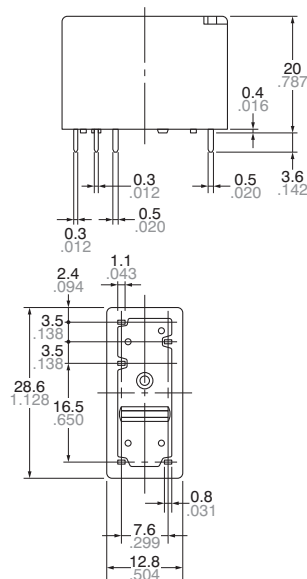

PC board pattern
(Copper-side view)

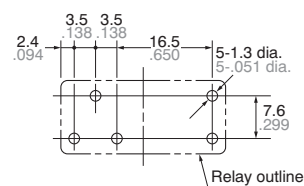

Tolerance: $\pm 0.1 \pm .004$
 Wiring diagram (Bottom view)

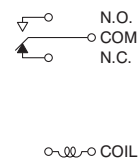

CAD Data 2 Form A

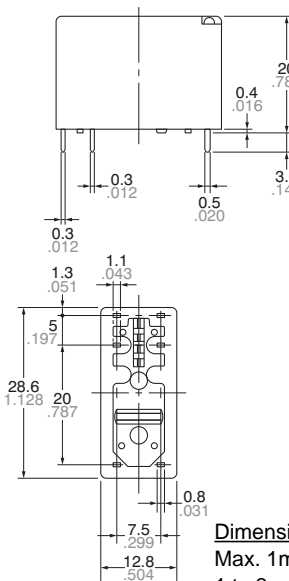

Dimension :
 Max. 1mm .039 inch
 1 to 3mm .039 to .118 inch
 Min. 3mm .118 inch

General tolerance
 $\pm 0.1 \pm .004$
 $\pm 0.2 \pm .008$
 $\pm 0.3 \pm .012$

PC board pattern
(Copper-side view)

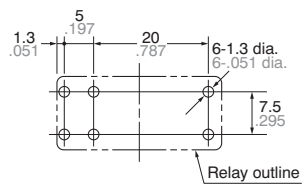

Tolerance: $\pm 0.1 \pm .004$
 Wiring diagram (Bottom view)

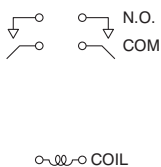

CAD Data 2 Form C

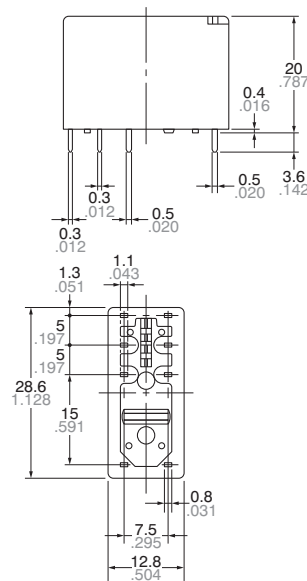

PC board pattern
(Copper-side view)

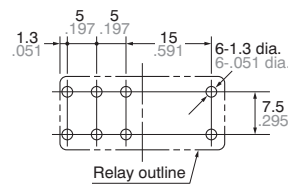

Tolerance: $\pm 0.1 \pm .004$
 Wiring diagram (Bottom view)

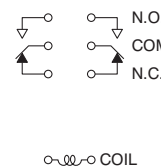

REFERENCE DATA

1-(1). Maximum operating power
1 Form A Standard (5 A) type

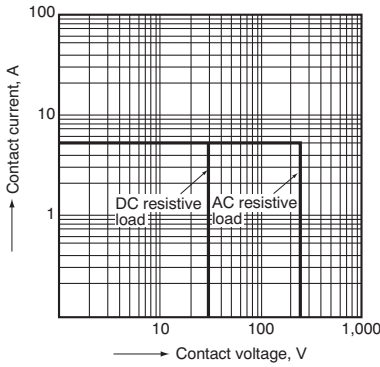

1-(2). Maximum operating power
1 Form A High Capacity (10 A) type

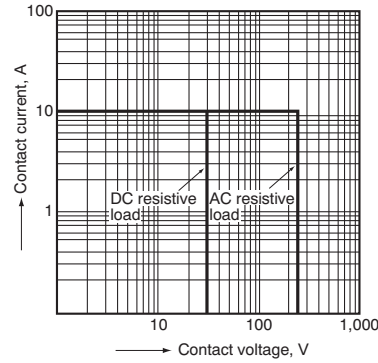

1-(3). Maximum operating power
1 Form C Standard (5 A) type

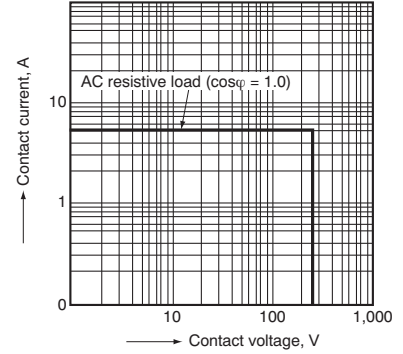

1-(4). Maximum operating power
1 Form C High Capacity (10 A) type

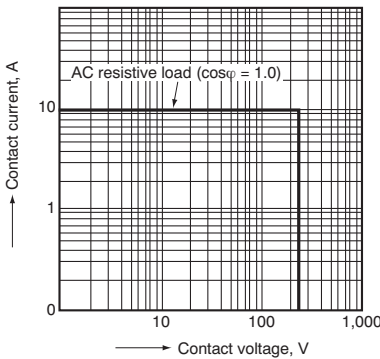

1-(5). Maximum operating power
2 Form A Standard (5 A) type

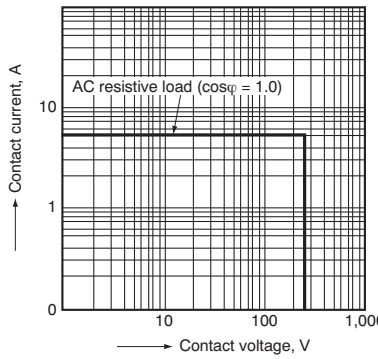

1-(6). Maximum operating power
2 Form C Standard (5 A) type

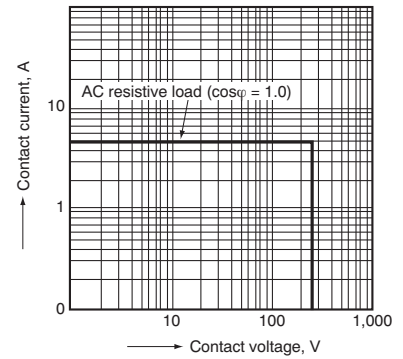

2-(1). Life curve
1 Form A Standard (5 A) type

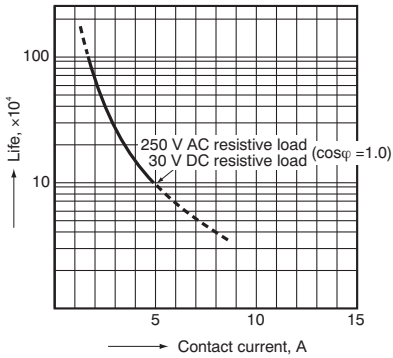

2-(2). Life curve
1 Form A High Capacity (10 A) type

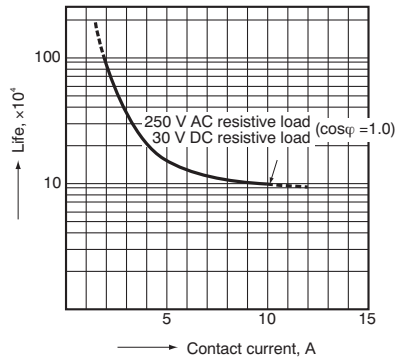

3-(1). Operate/release time
Sample: JW1aSN-DC12V-F, 10 pcs.
Ambient temperature: 20°C 68°F

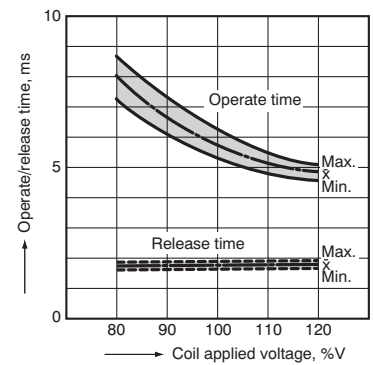

3-(2). Operate/release time
Sample: JW1aFSN-DC12V, 10 pcs.
Ambient temperature: 20°C 68°F

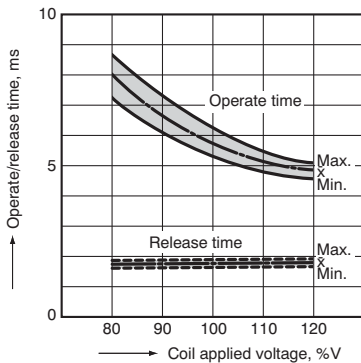

3-(3). Operate/release time
Sample: JW1SN-DC12V-F, 6 pcs.
Ambient temperature: 20°C 68°F

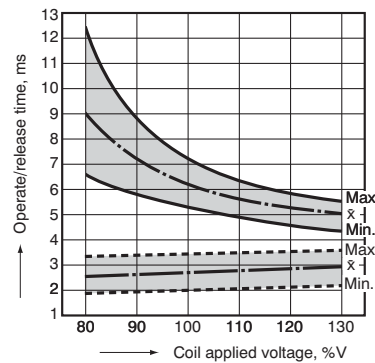

3-(4). Operate/release time
Sample: JW2aSN-DC24V-F, 6 pcs.
Ambient temperature: 20°C 68°F

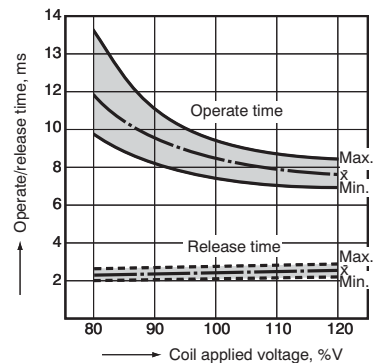

3-(5). Operate/release time
 Sample: JW2SN-DC12V-F, 6 pcs.
 Ambient temperature: 20°C 68°F

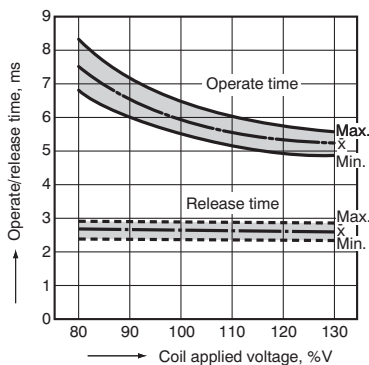

4-(1). Coil temperature rise
 (Contact carrying current: 5A)
 Sample JW1aFSN-DC12V-F, 6 pcs.
 Point measured: Inside the coil

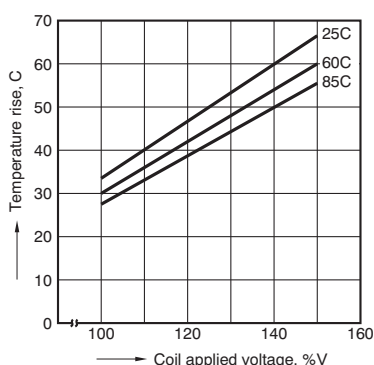

4-(2). Coil temperature rise
 (Contact carrying current: 10 A)
 Sample: JW1aFSN-DC12V-F, 6 pcs.
 Point measured: Inside the coil

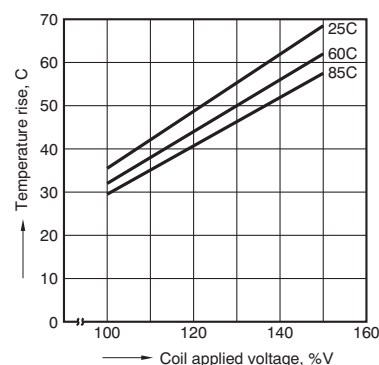

ACCESSORIES

DIN terminal sockets

JW1SI

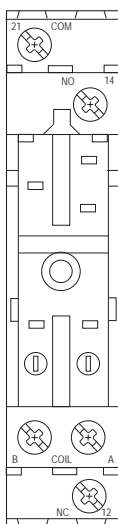

JW2SI

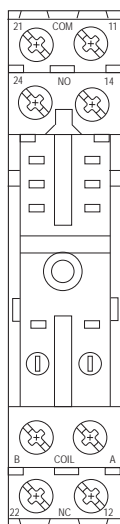

PCB sockets

JW1PI



JW2PI

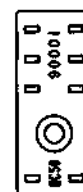

Retaining springs

JWHFSI



JWHFI



h (relay height) = 20.4 mm

DIMENSIONS

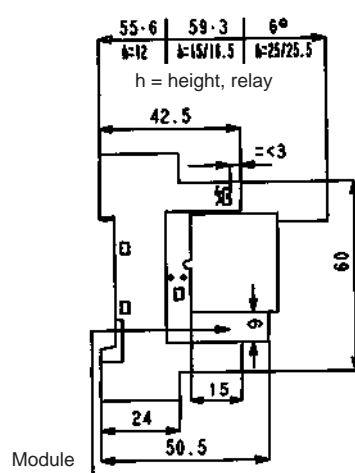
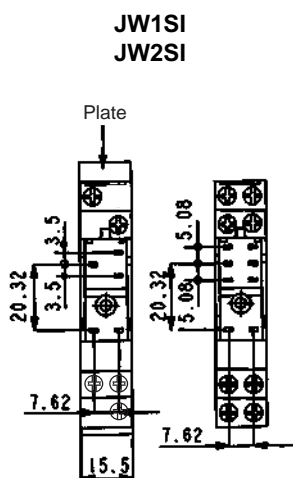

JW1PI

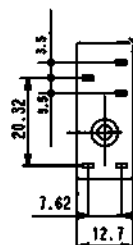

JW2PI

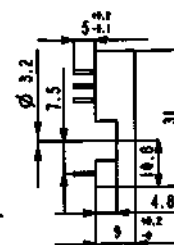
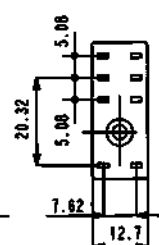

SAFETY STANDARDS

Item	UL/C-UL (Recognized)		CSA (Certified)		VDE (Certified)		TV rating (UL/CSA)		TÜV (Certified)		SEMKO (Certified)		FIMKO		SEV	
	File No.	Contact rating	File No.	Contact rating	File No.	Contact rating	File No.	Rating	File No.	Rating	File No.	Contact rating	File No.	Contact rating	File No.	Contact rating
Standard type 1 Form A	E43028	5A 277V AC 5A 30V DC 1/8HP 125V AC 1/8HP 250V AC	LR26550 etc.	5A 277V AC 5A 30V DC 1/8HP 125V AC 1/8HP 250V AC B300	40013854	5A 250V AC (cosφ=1.0) 3A 250V AC (cosφ=0.4) Standard type 5A 30V DC (0ms)	UL E43028 CSA LR26550 etc.	1a→TV-5	B 08 11 13461 257	5A 250V AC (cosφ=1.0) 3A 250V AC (cosφ=0.4) 5A 30V DC (0ms)	817817	5A 250V AC (cosφ=1.0) 5A 30V DC (0ms)	24965	5A 250V AC (cosφ=1.0) 5A 30V DC (0ms)	09. 0901	5A 250V AC (cosφ=1.0)
Standard type 1 Form C	E43028	5A 277V AC 5A 30V DC 1/8HP 125V AC 1/8HP 250V AC	LR26550 etc.	5A 277V AC 5A 30V DC 1/8HP 125V AC 1/8HP 250V AC B300	40013854	5A 250V AC (cosφ=1.0) 3A 250V AC (cosφ=0.4) Standard type 5A 30V DC (0ms)	—	—	B 08 11 13461 257	5A 250V AC (cosφ=1.0) 3A 250V AC (cosφ=0.4) 5A 30V DC (0ms)	817817	5A 250V AC (cosφ=1.0) 5A 30V DC (0ms)	24965	5A 250V AC (cosφ=1.0) 5A 30V DC (0ms)	09. 0901	5A 250V AC (cosφ=1.0)
Standard type 2 Form A	E43028	5A 277V AC 5A 30V DC 1/8HP 125V AC 1/8HP 250V AC B300	LR26550 etc.	5A 277V AC 5A 30V DC 1/8HP 125V AC 1/8HP 250V AC B300	40013854	5A 250V AC (cosφ=1.0) 3A 250V AC (cosφ=0.4) Standard type 5A 30V DC (0ms)	—	—	B 08 11 13461 257	5A 250V AC (cosφ=1.0) 3A 250V AC (cosφ=0.4) 5A 30V DC (0ms)	817817	5A 250V AC (cosφ=1.0) 5A 30V DC (0ms)	24965	5A 250V AC (cosφ=1.0) 5A 30V DC (0ms)	09. 0901	5A 250V AC (cosφ=1.0)
Standard type 2 Form C	E43028	5A 277V AC 5A 30V DC 1/8HP 125V AC 1/8HP 250V AC B300	LR26550 etc.	5A 277V AC 5A 30V DC 1/8HP 125V AC 1/8HP 250V AC B300	40013854	5A 250V AC (cosφ=1.0) 3A 250V AC (cosφ=0.4) Standard type 5A 30V DC (0ms)	—	—	B 08 11 13461 257	5A 250V AC (cosφ=1.0) 3A 250V AC (cosφ=0.4) 5A 30V DC (0ms)	817817	5A 250V AC (cosφ=1.0) 5A 30V DC (0ms)	24965	5A 250V AC (cosφ=1.0) 5A 30V DC (0ms)	09. 0901	5A 250V AC (cosφ=1.0)
High capacity type 1 Form A	E43028	10A 277V AC 10A 30V DC 1/8HP 125V AC 1/8HP 250V AC	LR26550 etc.	10A 277V AC 10A 30V DC 1/8HP 125V AC 1/8HP 250V AC B300	40013854	10A 250V AC (cosφ=1.0) 7A 250V AC (cosφ=0.4) High capacity type 10A 30V DC (0ms)	UL E43028 CSA LR26550	1a→TV-5	B 08 11 13461 257	10A 250V AC (cosφ=1.0) 7A 250V AC (cosφ=0.4) 10A 30V DC (0ms)	817817	10A 250V AC (cosφ=1.0) 10A 30V DC (0ms)	24965	10A 250V AC (cosφ=1.0) 5A 30V DC (0ms)	09. 0901	10A 250V AC (cosφ=1.0)
High capacity type 1 Form C	E43028	10A 277V AC 10A 30V DC 1/8HP 125V AC 1/8HP 250V AC	LR26550 etc.	10A 277V AC 10A 30V DC 1/8HP 125V AC 1/8HP 250V AC B300	40013854	10A 250V AC (cosφ=1.0) 7A 250V AC (cosφ=0.4) High capacity type 10A 30V DC (0ms)	—	—	B 08 11 13461 257	10A 250V AC (cosφ=1.0) 7A 250V AC (cosφ=0.4) 10A 30V DC (0ms)	817817	10A 250V AC (cosφ=1.0) 10A 30V DC (0ms)	24965	10A 250V AC (cosφ=1.0) 5A 30V DC (0ms)	09. 0901	10A 250V AC (cosφ=1.0)

For Cautions for Use, see [Relay Technical Information](#).