



TAOGLAS®



Datasheet

Havok

Part No:
PCS.06.A

Description:

Low Profile LTE/Cellular 4G/3G/2G SMD Dielectric Antenna

Features:

SMD Dielectric Antenna
698~960MHz/1710~2690MHz
High Efficiency SMD antenna
Low profile 42*10*3mm
RoHS & REACH Compliant

1. Introduction	3
2. Specifications	4
3. Antenna Characteristics	6
4. Radiation Patterns	9
5. Mechanical Drawing	22
6. Intergration Guide	23
7. Packaging	31
<hr/>	
Changelog	33

Taoglas makes no warranties based on the accuracy or completeness of the contents of this document and reserves the right to make changes to specifications and product descriptions at any time without notice. Taoglas reserves all rights to this document and the information contained herein. Reproduction, use or disclosure to third parties without express permission is strictly prohibited.



1. Introduction



The Havok PCS.06.A is a low profile SMD LTE/cellular 4G/3G/2G embedded antenna designed for direct SMD mount on a device PCB. It provides high efficiency in a very small factor 42*10*3mm. If tuning is required it can be tuned for the device environment, while there is no need for new tooling.

Its rectangular shape and small size makes it very easy to integrate – packaged in tape and reel, it can be mounted via pick and place to reflow solder directly on the edge of the PCB board. This antenna is recommended to be used with long ground-plane lengths of 120mm or more to attain its highest rated efficiency, note the return loss and efficiency graphs.

Typical Applications Include:

- Connected Health
- Handheld Devices
- Wearables

The antenna is suitable for lower cost LTE/cellular applications due to the ease of integration. Contact your regional Taoglas customer support team for quick and professional support from our senior engineering team on integration and matching of the antenna to your device.

2. Specifications

ELECTRICAL							
Frequency (MHz)	698~803	824~894	880~960	1710~1880	1850~1990	1920~2170	2500~2690
Peak Gain (dBi)*	-0.21	0.77	0.61	3.05	2.92	3.17	3.72
Average Gain (dBi)*	-2.52	-1.91	-2.16	-1.87	-1.85	-1.79	-2.30
Efficiency (%)*	45%	64.38	60.99	65.02	65.36	66.19	58.99
Return Loss (dB)*	<-10 typ. <-7 at the band edge		<-10 typ. <-7 at the band edge			<-10 typ. <-6 at the band edge	
Polarization	Linear						
Impedance	50Ω						
Maximum Input Power	5W						
Mechanical							
Antenna Dimensions	42mm x 10mm x 3mm						
Material	FR4						
Weight	2.50g						
Soldering Type	SMD Reflow						
Environmental							
Operation Temperature	-40°C ~ +85°C						
Storage Temperature	-40°C ~ +85°C						
Moisture Sensitivity Level	3						

* All measurements were done on 123*45mm EVB board with 100mm length ground plane.

5G/4G Bands			
Band Number	5G NR / FR1 / LTE / LTE-Advanced / WCDMA / HSPA / HSPA+ / TD-SCDMA		
	Uplink	Downlink	Covered
1	UL: 1920 to 1980	DL: 2110 to 2170	✓
2	UL: 1850 to 1910	DL: 1930 to 1990	✓
3	UL: 1710 to 1785	DL: 1805 to 1880	✓
4	UL: 1710 to 1755	DL: 2110 to 2155	✓
5	UL: 824 to 849	DL: 869 to 894	✓
7	UL: 2500 to 2570	DL: 2620 to 2690	✓
8	UL: 880 to 915	DL: 925 to 960	✓
9	UL: 1749.9 to 1784.9	DL: 1844.9 to 1879.9	✓
11	UL: 1427.9 to 1447.9	DL: 1475.9 to 1495.9	✗
12	UL: 699 to 716	DL: 729 to 746	✓
13	UL: 777 to 787	DL: 746 to 756	✓
14	UL: 788 to 798	DL: 758 to 768	✓
17	UL: 704 to 716	DL: 734 to 746	✓
18	UL: 815 to 830	DL: 860 to 875	✓
19	UL: 830 to 845	DL: 875 to 890	✓
20	UL: 832 to 862	DL: 791 to 821	✓
21	UL: 1447.9 to 1462.9	DL: 1495.9 to 1510.9	✗
22	UL: 3410 to 3490	DL: 3510 to 3590	✗
23	UL: 2000 to 2020	DL: 2180 to 2200	✓
24	UL: 1625.5 to 1660.5	DL: 1525 to 1559	✓
25	UL: 1850 to 1915	DL: 1930 to 1995	✓
26	UL: 814 to 849	DL: 859 to 894	✓
27	UL: 807 to 824	DL: 852 to 869	✓
28	UL: 703 to 748	DL: 758 to 803	✓
29	UL: -	DL: 717 to 728	✓
30	UL: 2305 to 2315	DL: 2350 to 2360	✓
31	UL: 452.5 to 457.5	DL: 462.5 to 467.5	✗
32	UL: -	DL: 1452 - 1496	✗
35		1850 to 1910	✓
38		2570 to 2620	✓
39		1880 to 1920	✓
40		2300 to 2400	✓
41		2496 to 2690	✓
42		3400 to 3600	✗
43		3600 to 3800	✗
48		3550 to 3700	✗
66	UL: 1710-1780	DL: 2110-2200	✓
71		617 to 698	✓
74/75/76		1427 to 1518	✓
78		3300 to 3800	✗
79		4400 to 5000	✗
85	698-716	728-746	✓

3. Antenna Characteristics

3.1 Return Loss

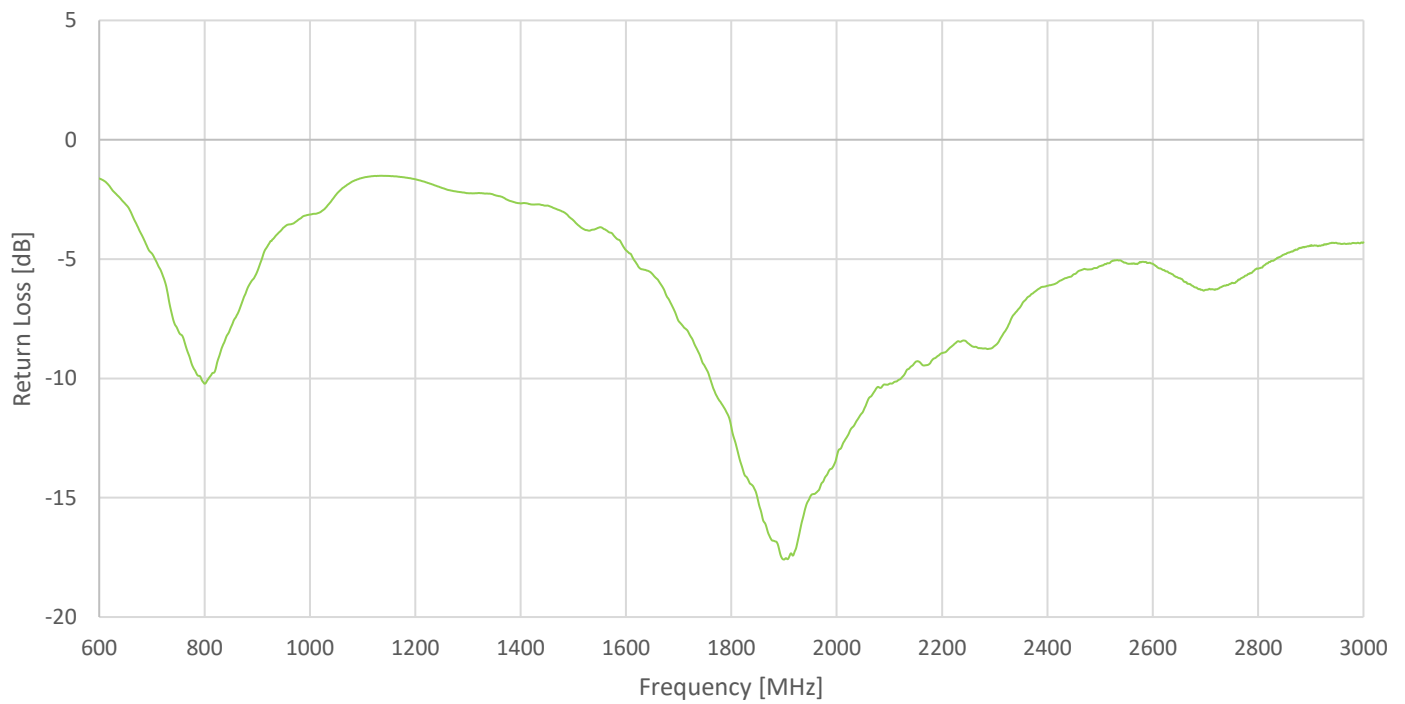

3.2 VSWR

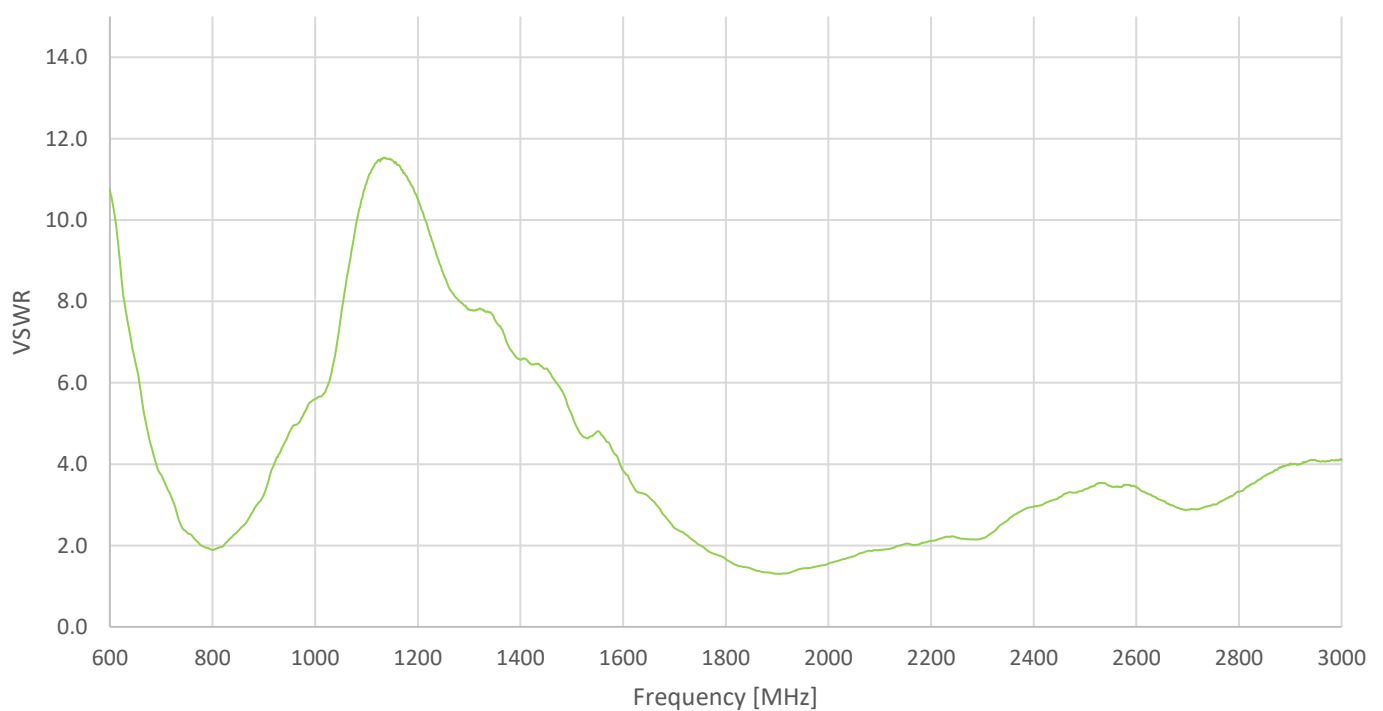

3.3 Efficiency

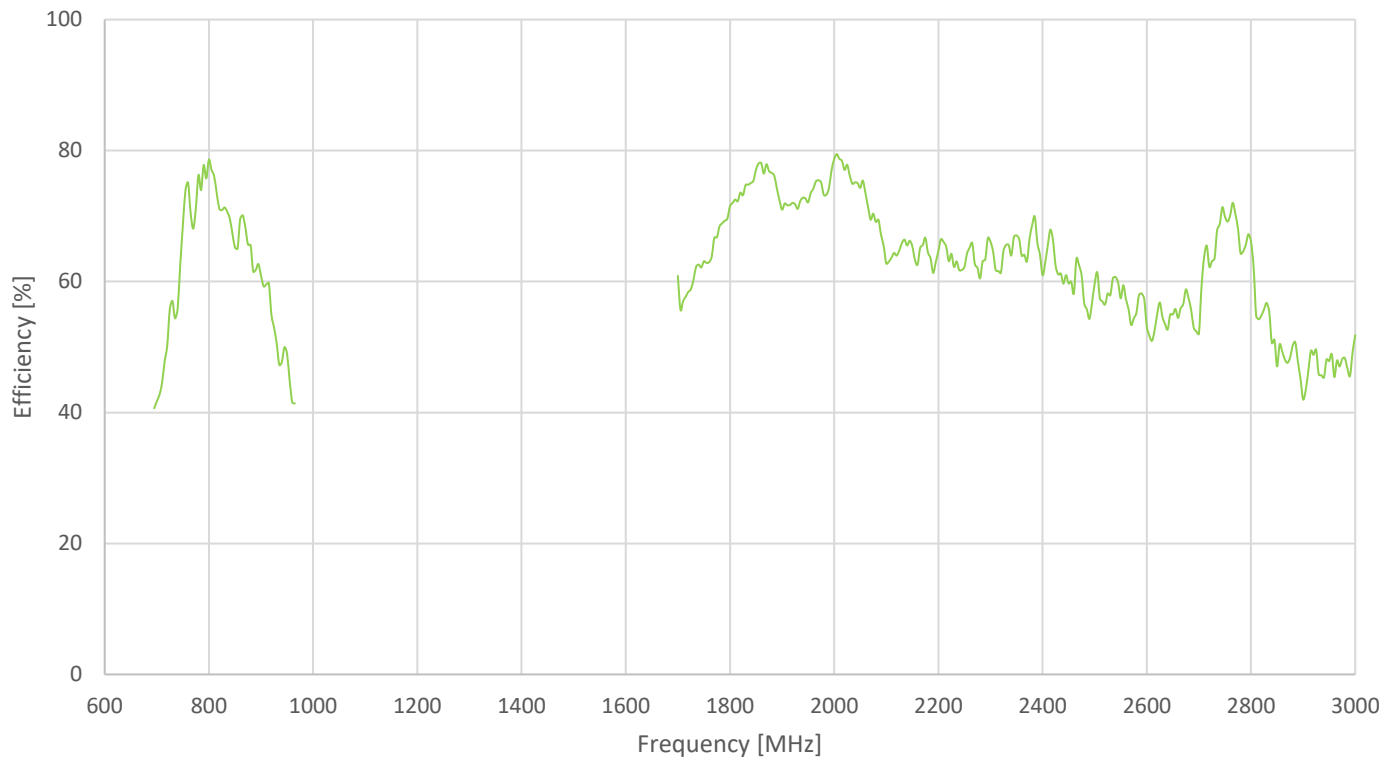

3.4 Peak Gain

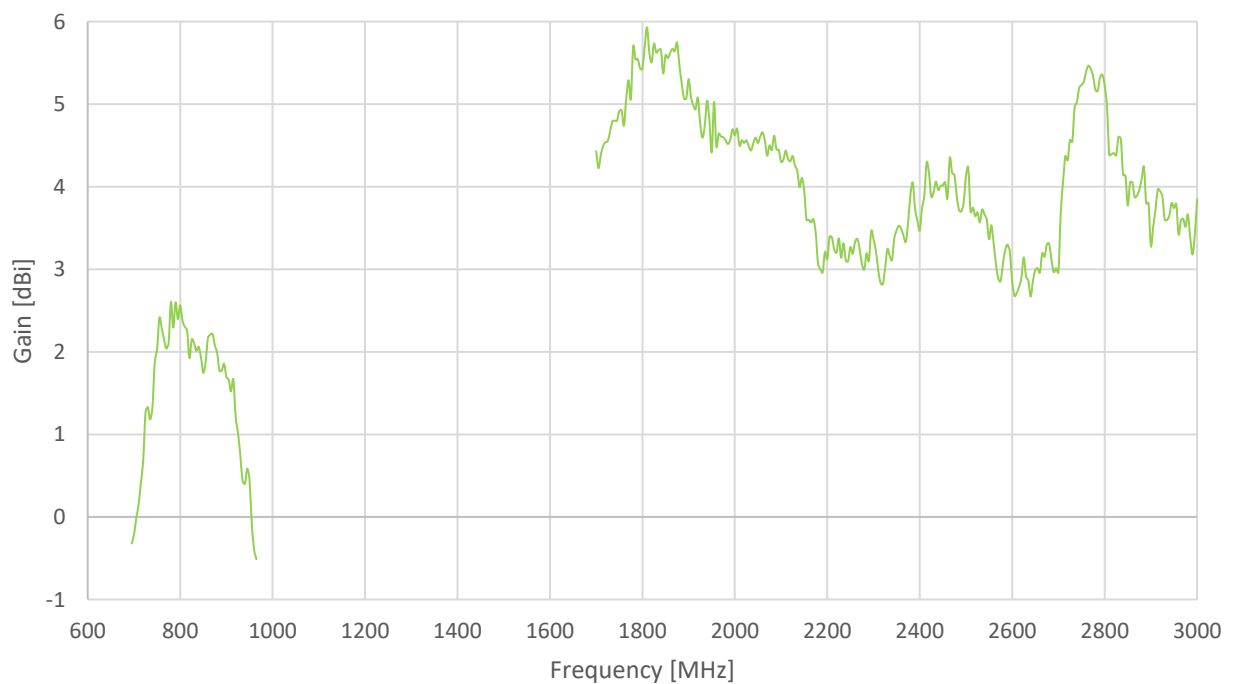

3.5 Average Gain

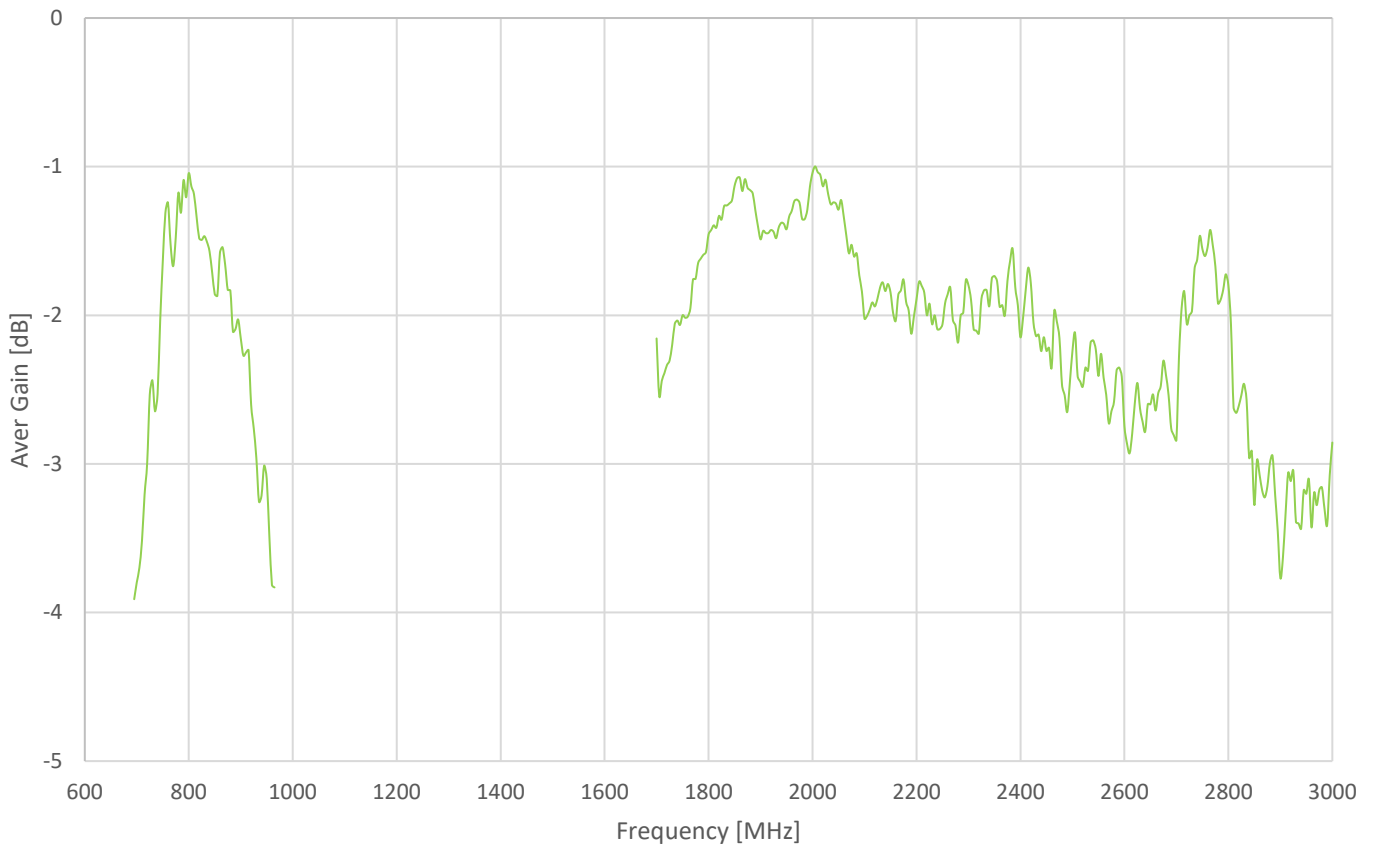

4. Radiation Patterns

4.1 Test Setup

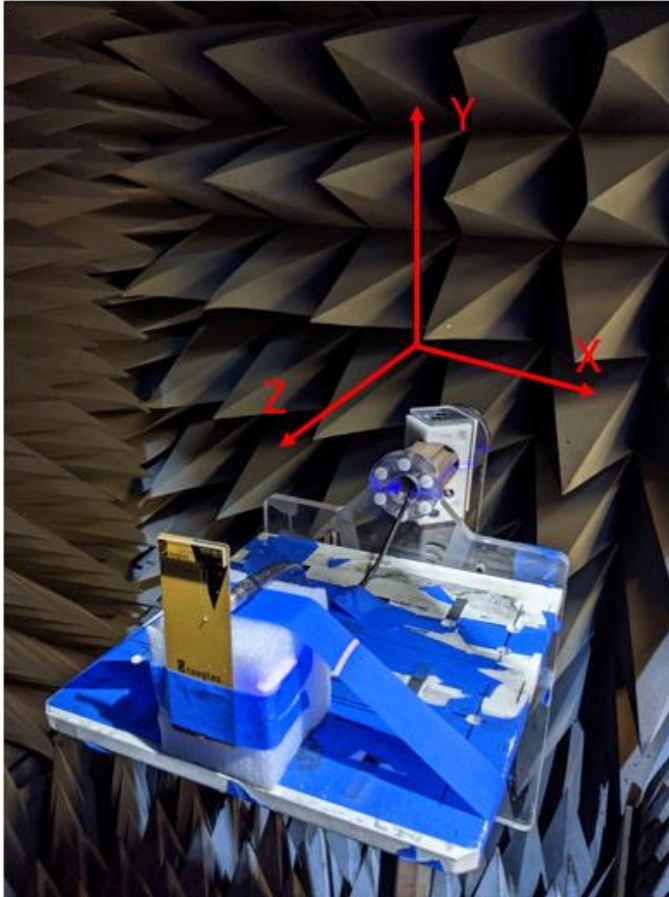

Chamber Set-up

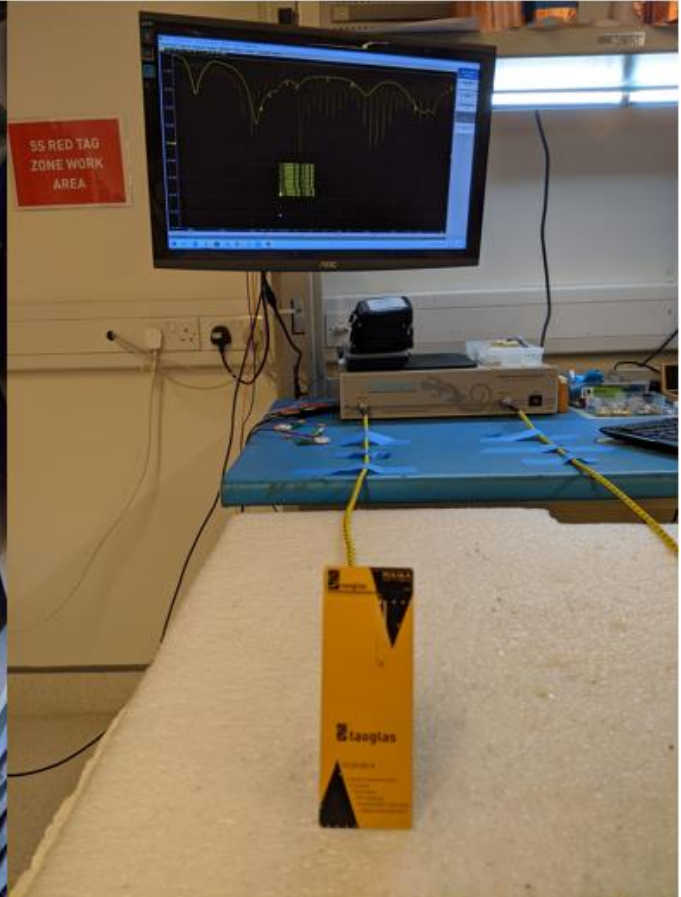

VNA Set-up

4.2 3D and 2D Radiation Patterns

695MHz

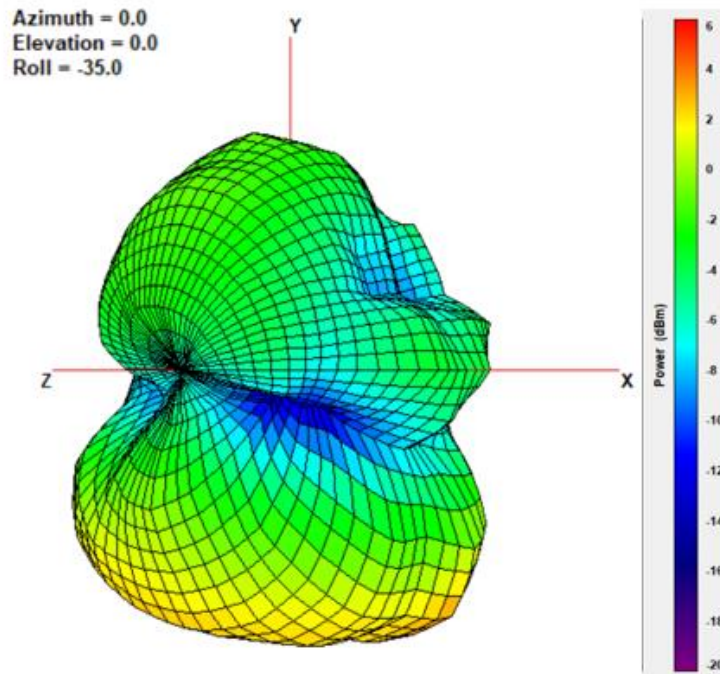

XY Plane

XZ Plane

YZ Plane

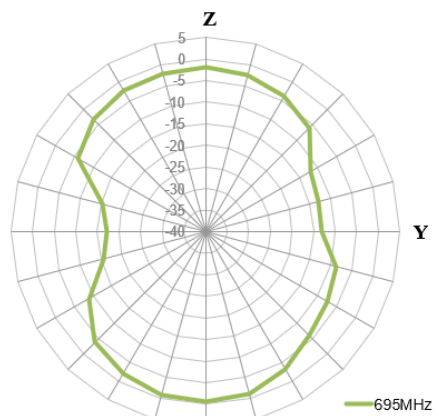
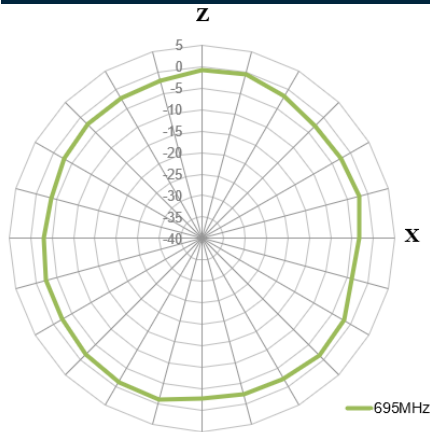
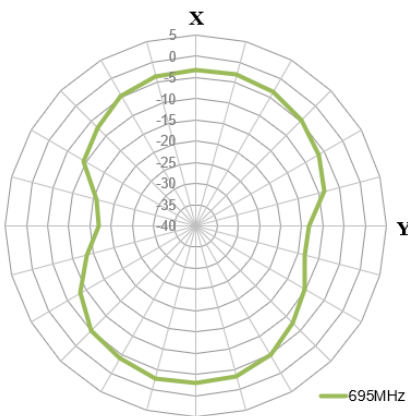

825MHz

Azimuth = 0.0
 Elevation = 0.0
 Roll = -35.0

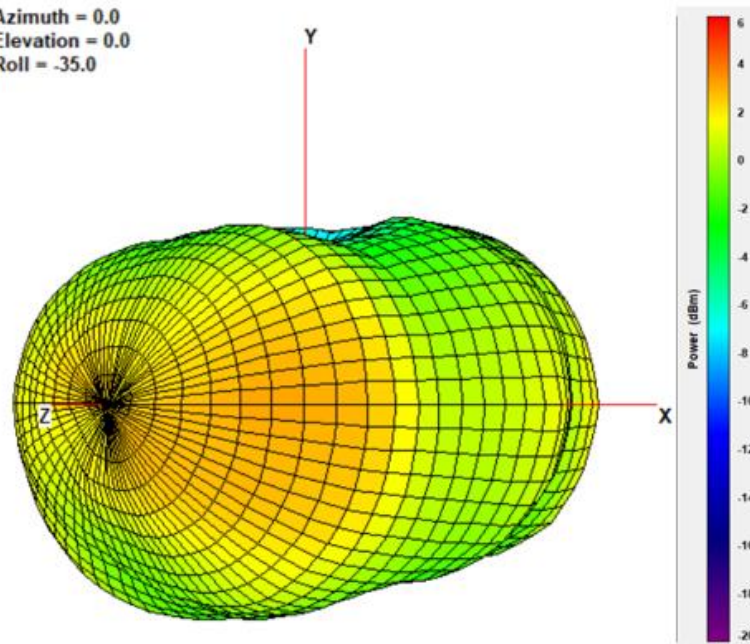

XY Plane

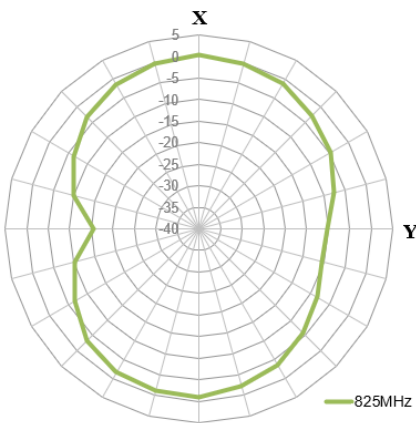

XZ Plane

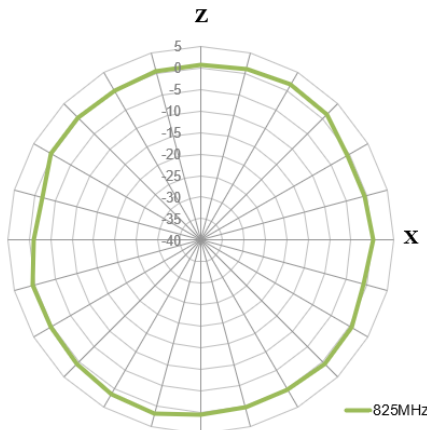

YZ Plane

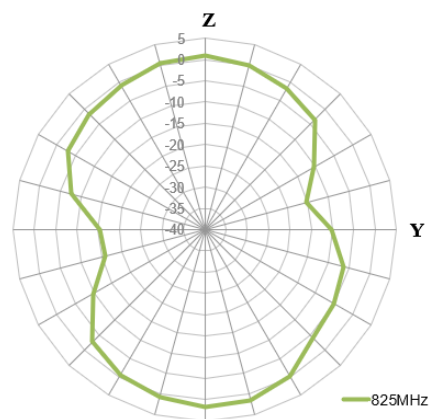

895MHz

Azimuth = 0.0
Elevation = 0.0
Roll = -35.0

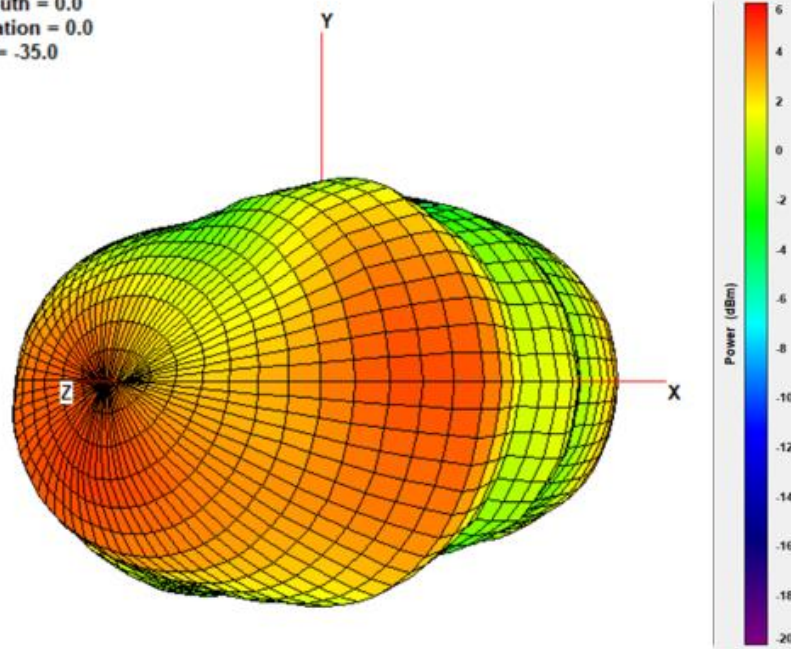

XY Plane XZ Plane YZ Plane

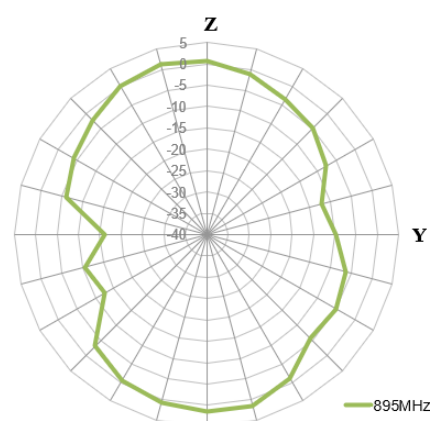
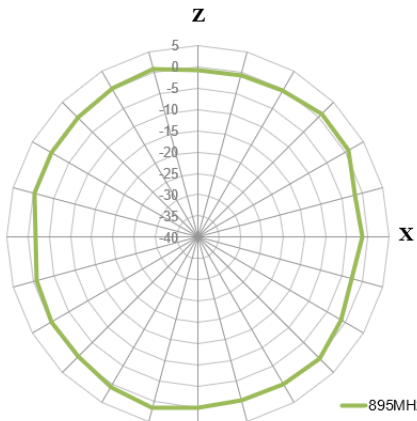
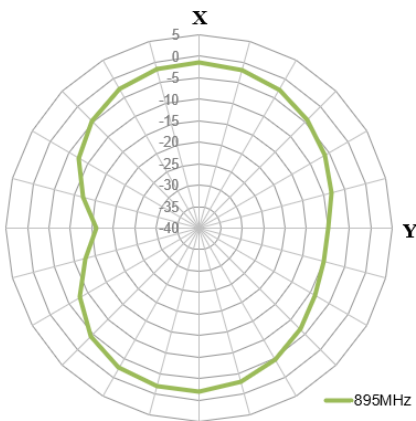

960MHz

Azimuth = 0.0
 Elevation = 0.0
 Roll = -35.0

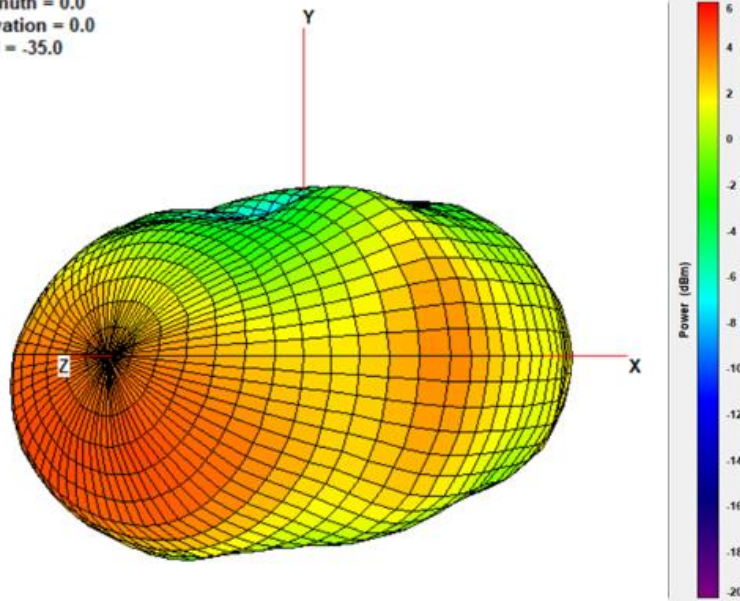

XY Plane

XZ Plane

YZ Plane

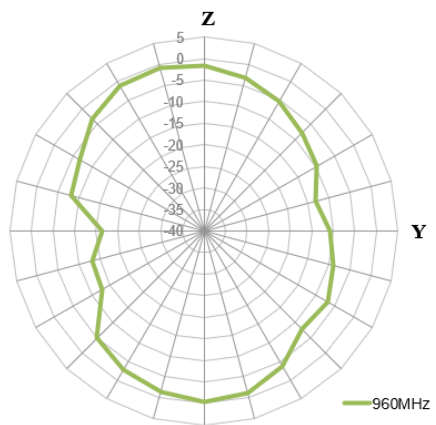
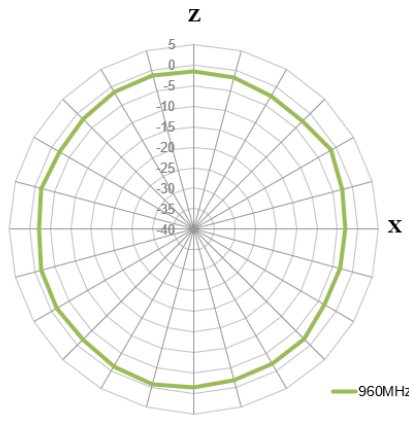
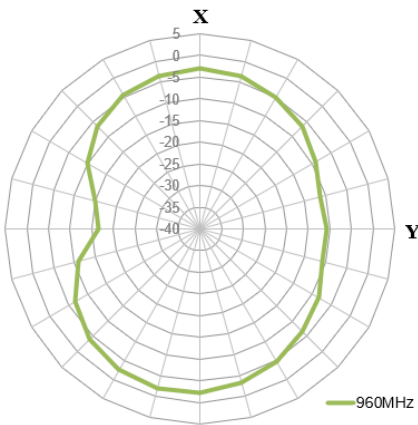

1710MHz

Azimuth = 0.0
Elevation = 0.0
Roll = -35.0

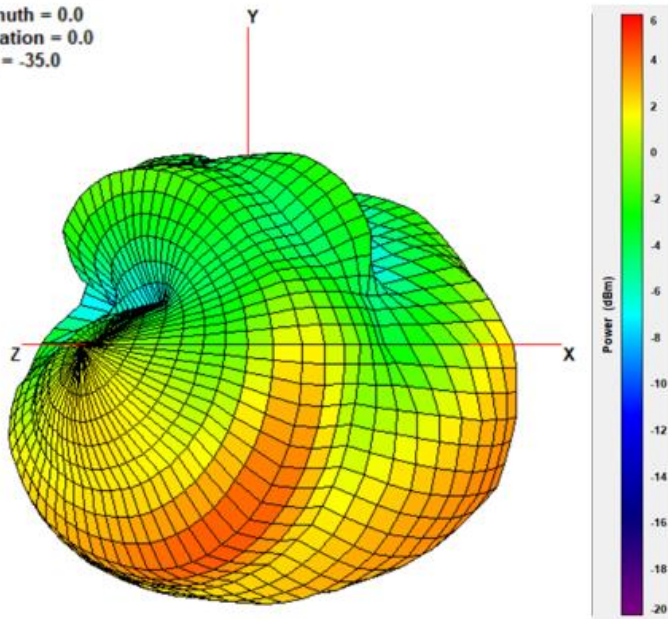

XY Plane

XZ Plane

YZ Plane

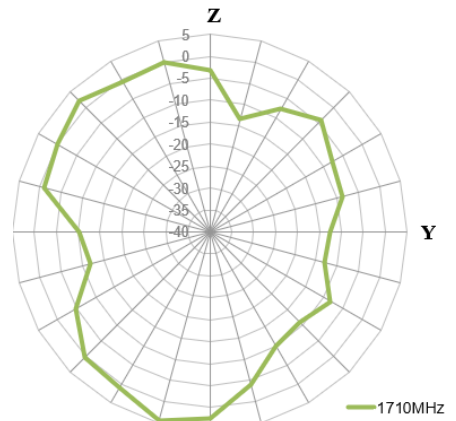
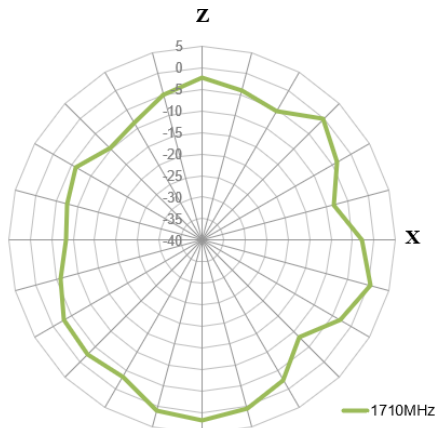
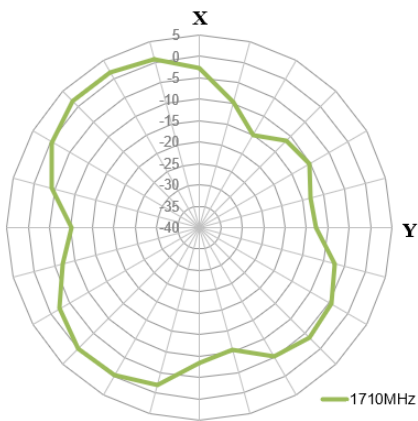

1805MHz

Azimuth = 0.0
Elevation = 0.0
Roll = -35.0

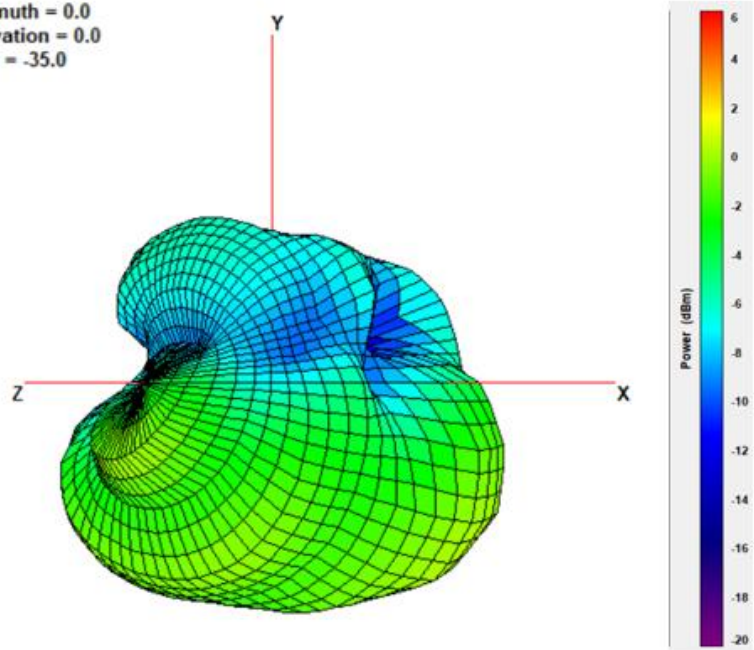

XY Plane

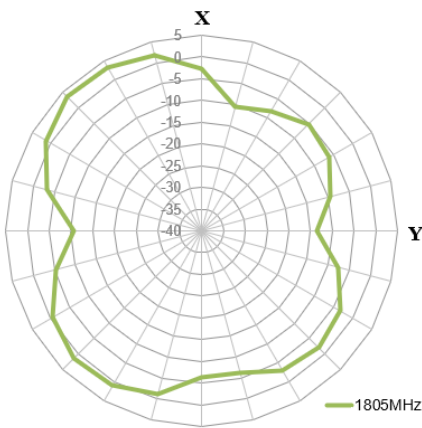

XZ Plane

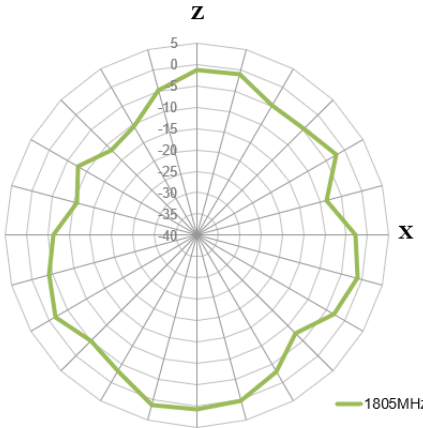

YZ Plane

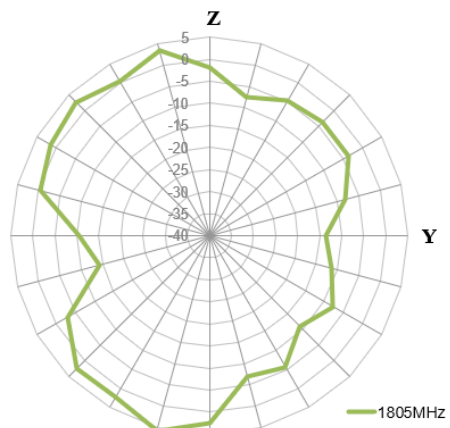

1910MHz

Azimuth = 0.0
Elevation = 0.0
Roll = -35.0

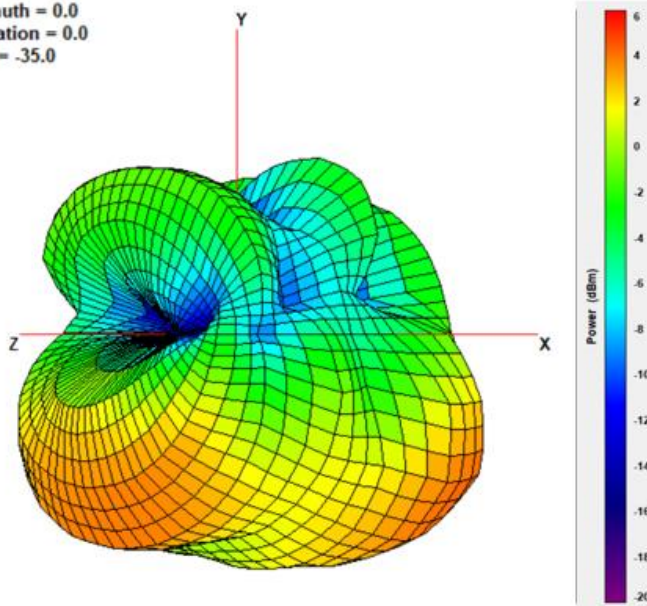

XY Plane

XZ Plane

YZ Plane

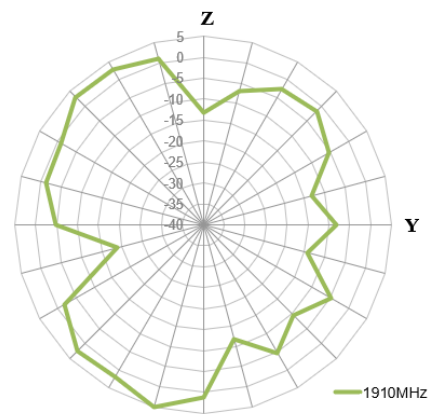
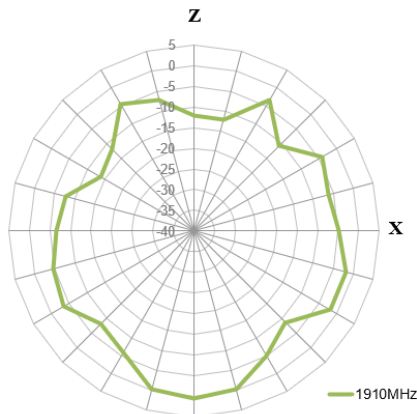
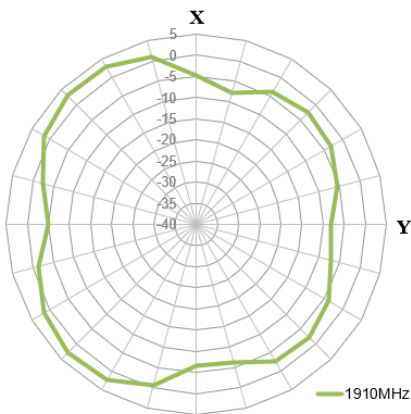

1990MHz

Azimuth = 0.0
Elevation = 0.0
Roll = -35.0

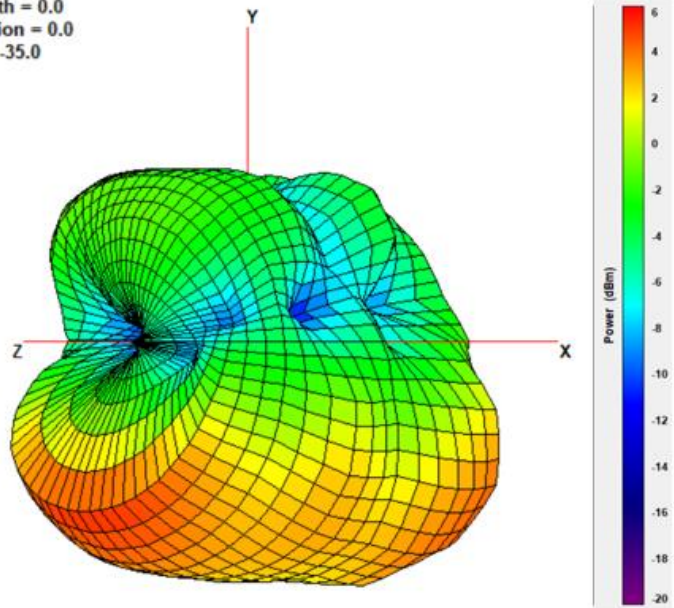

XY Plane

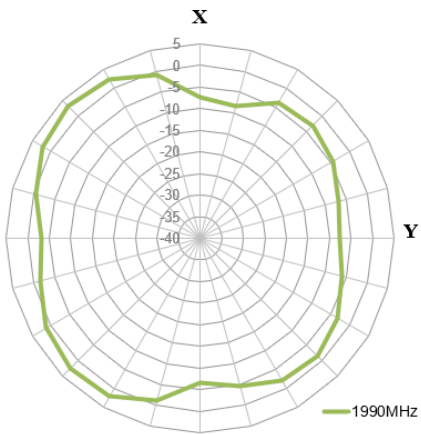

XZ Plane

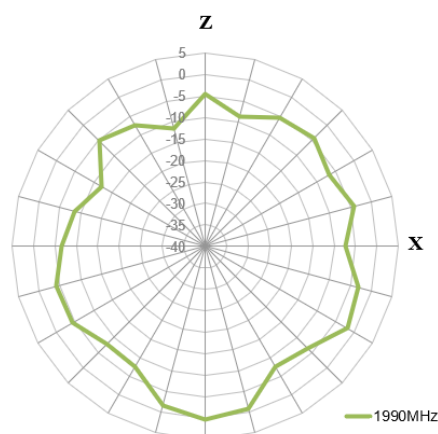

YZ Plane

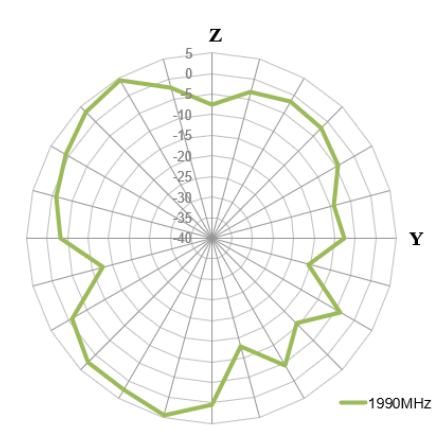

2170MHz

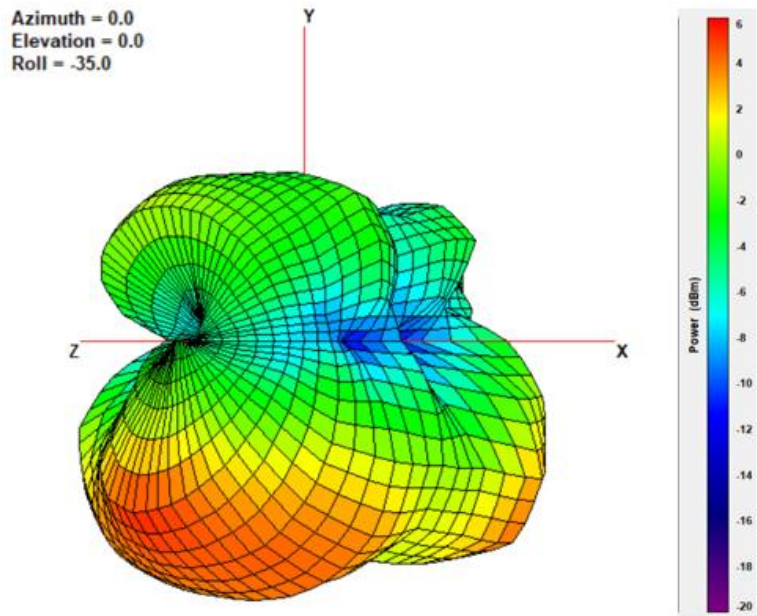

XY Plane XZ Plane YZ Plane

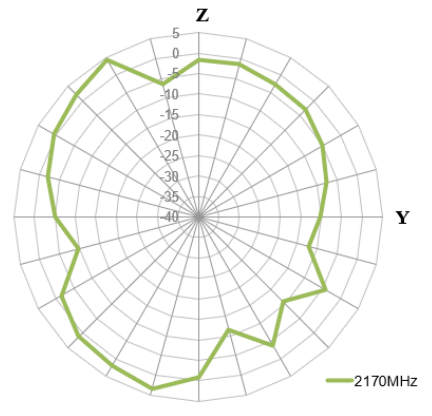
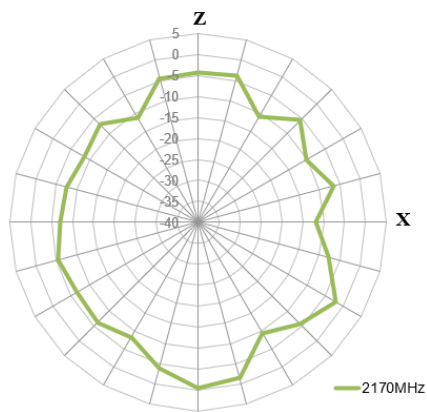
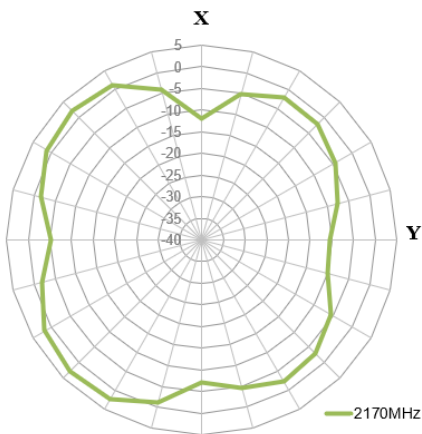

2500MHz

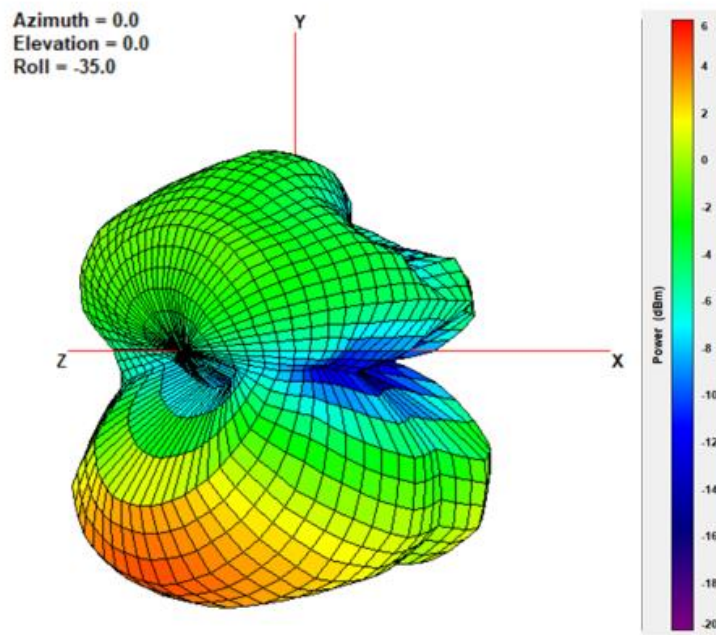

XY Plane

XZ Plane

YZ Plane

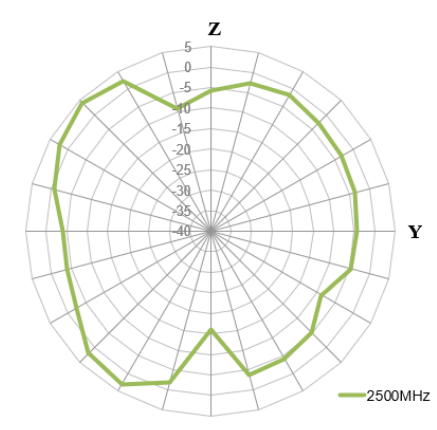
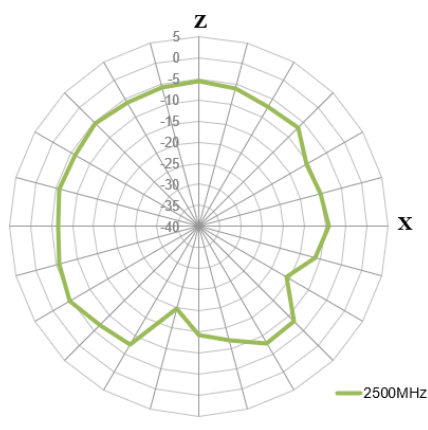
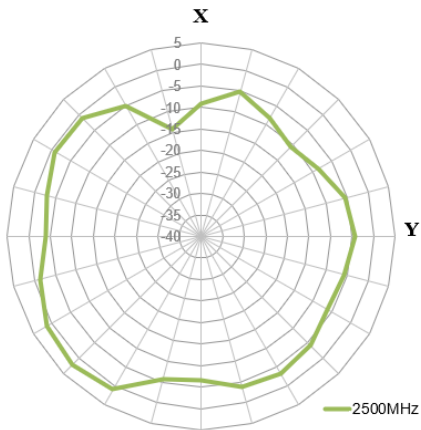

2620MHz

Azimuth = 0.0
Elevation = 0.0
Roll = -35.0

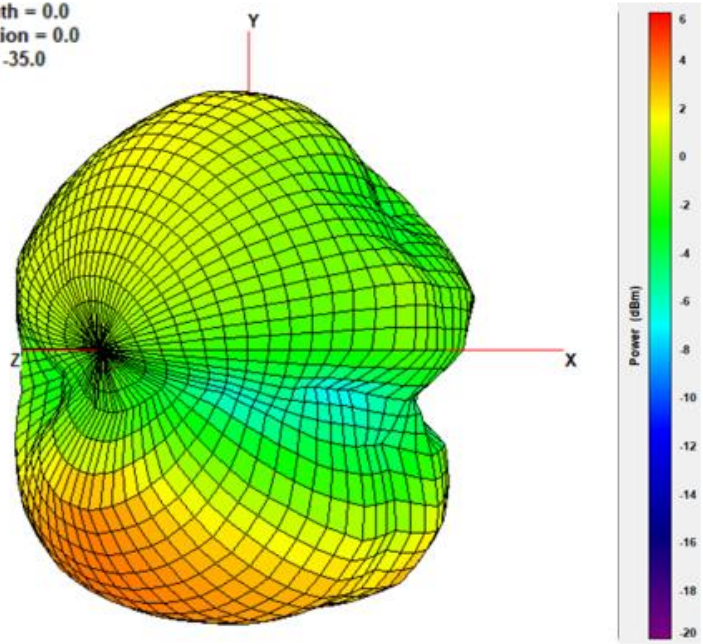

XY Plane

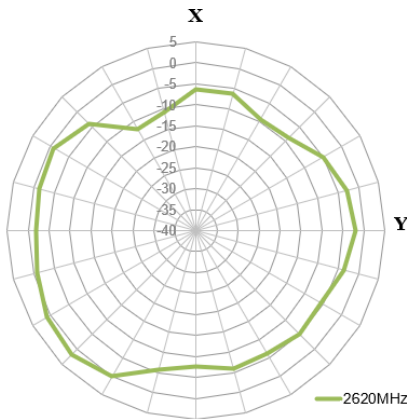

XZ Plane

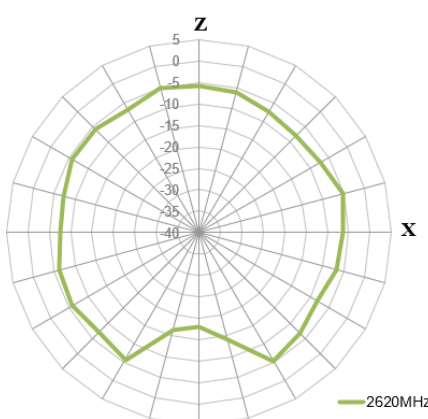

YZ Plane

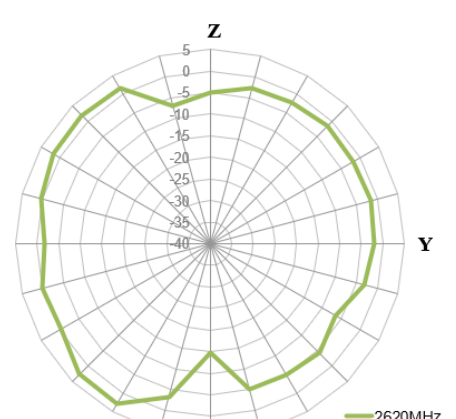

2690MHz

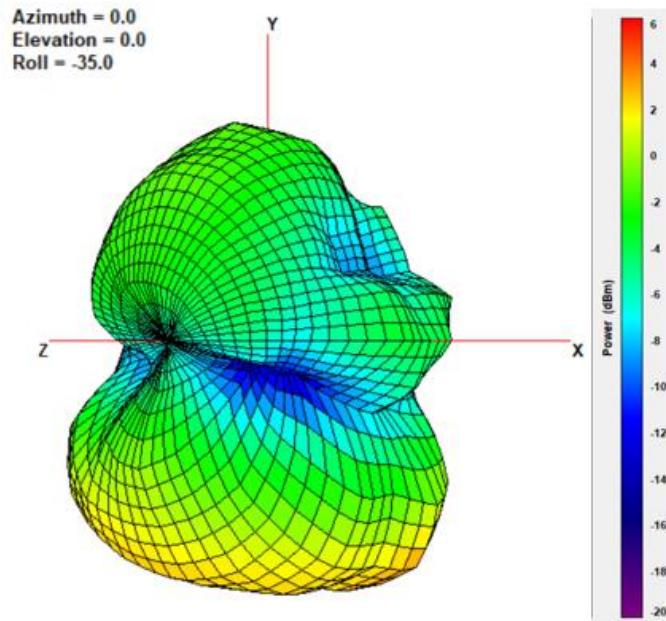

XY Plane XZ Plane YZ Plane

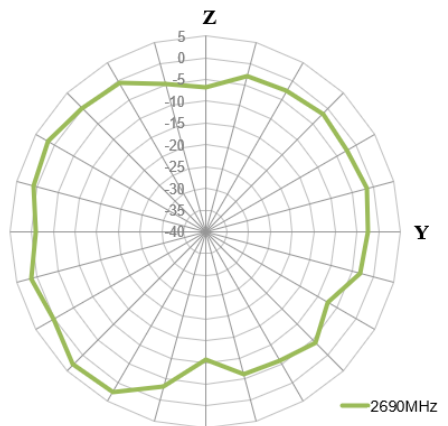
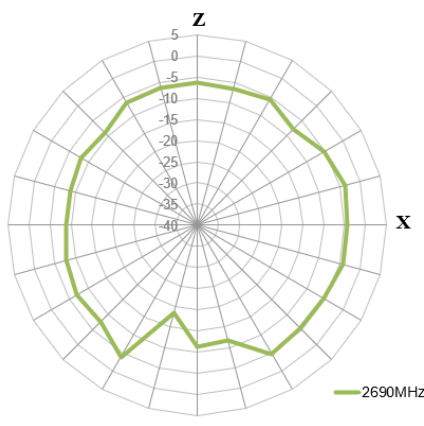
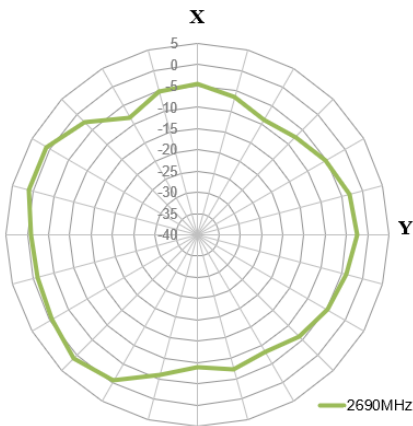

5. Mechanical Drawing (Units: mm)

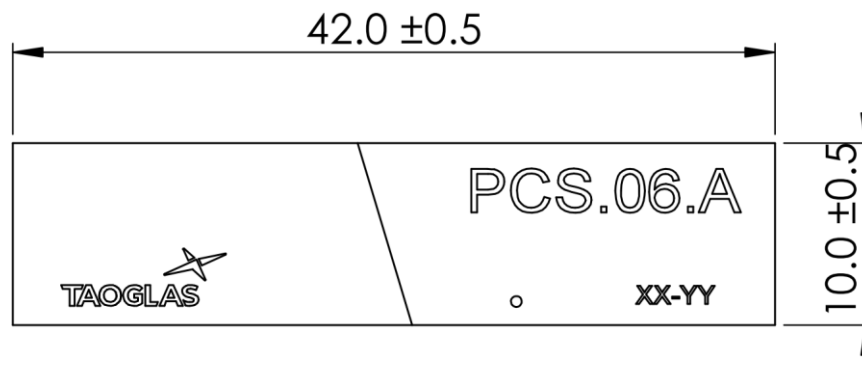

TOP VIEW

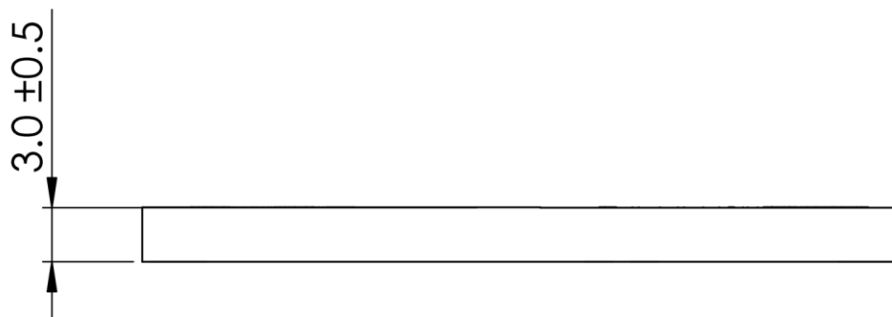

FRONT VIEW

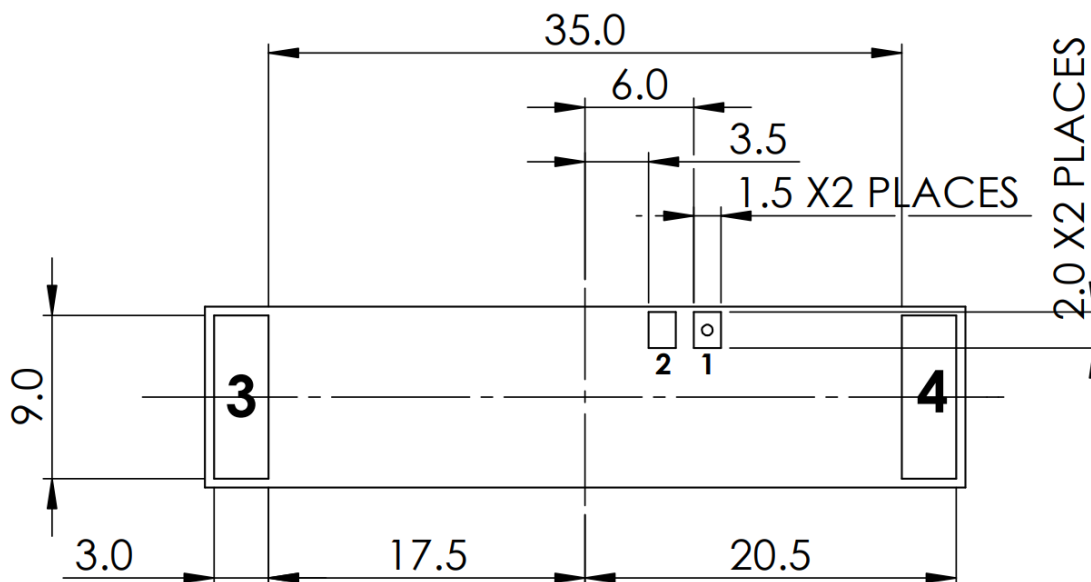

BOTTOM VIEW

6. Antenna Integration Guide

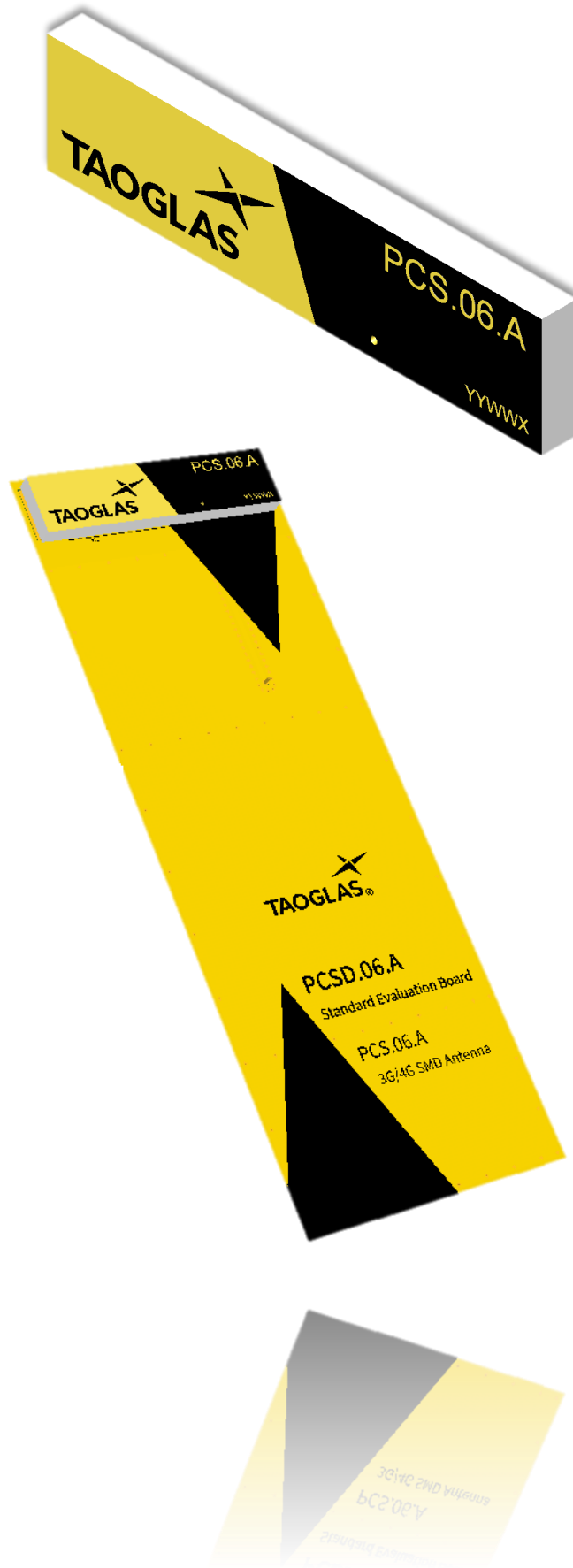

6.1 Schematic Symbol and Pin Definition

The circuit symbol for the antenna is shown below. The antenna has 4 pins with only two pins (Pin 1 and Pin 2) as functional. Pins 3 and 4 are for mechanical strength.

Pin	Description
1	RF Feed
2	Ground
3, 4	Mechanical, Not Connected

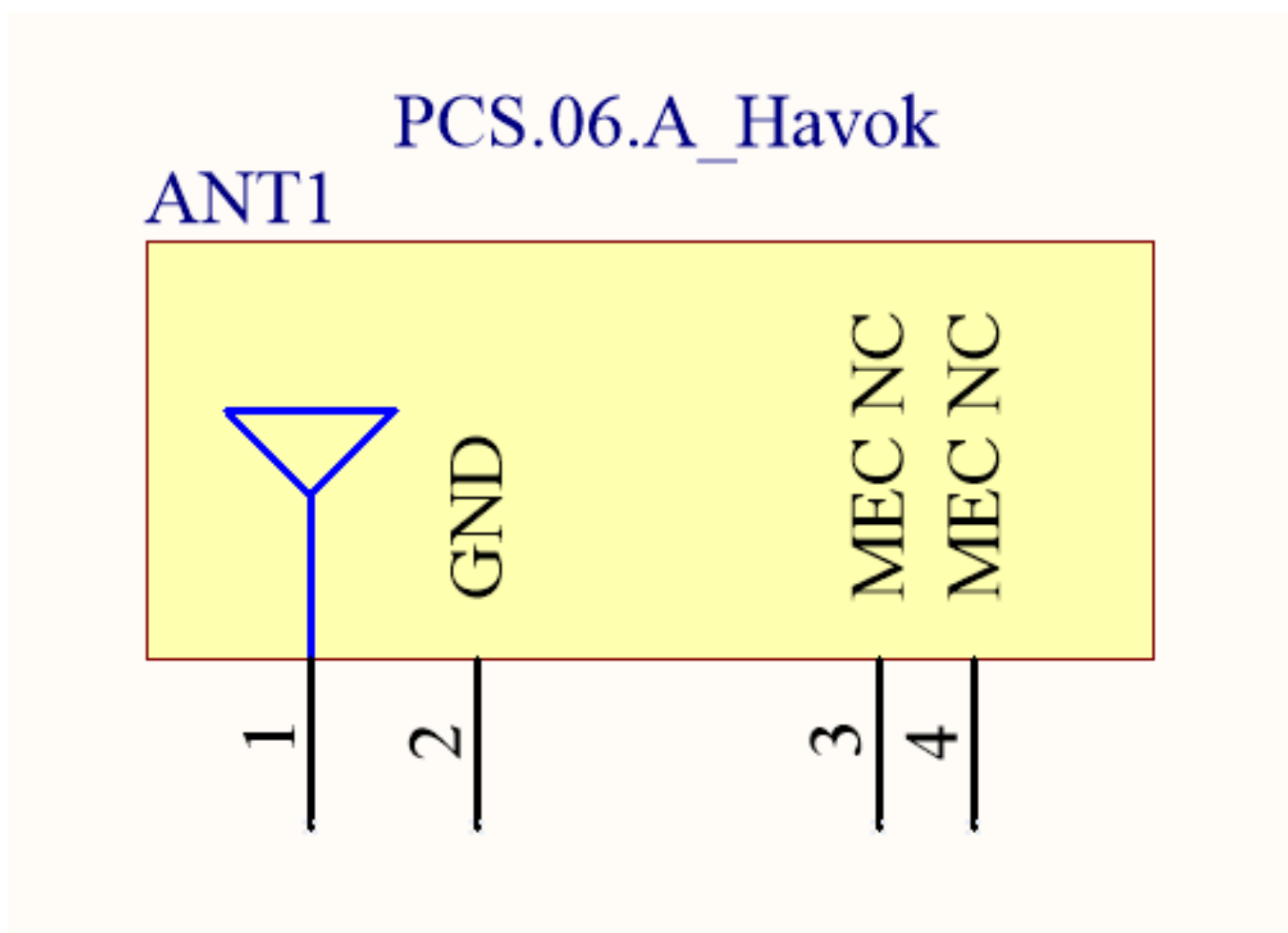

Please note you can download the design files, 3D model, 2D drawings and CST simulation files from the website here:

<https://www.taoglas.com/product/havok-pcs-06-2g3g4g-low-profile-smd-antenna-2/>

6.2 Antenna Integration

Whatever the size of the PCB, the antenna should ideally be placed on the PCB's shortest side, to take advantage of the ground plane. Optimized matching components can be placed as shown.

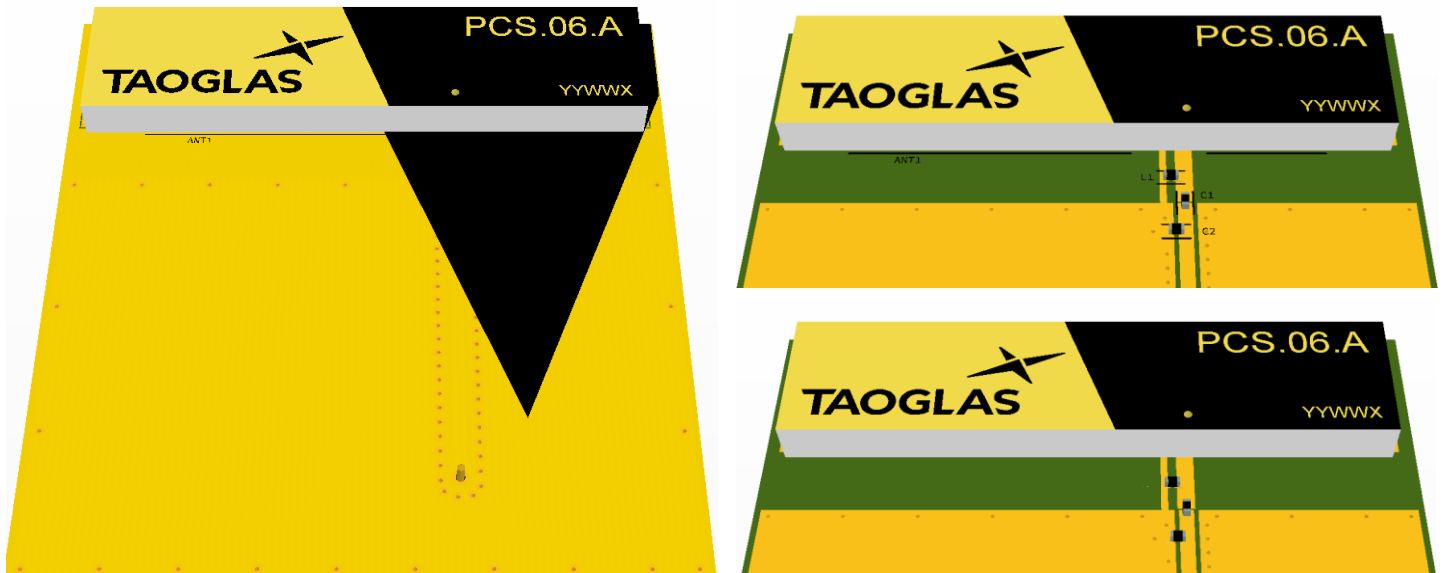

6.3 PCB Layout

The footprint and clearance on the PCB must meet the antenna specification. An example of the PCB layout shows the antenna footprint with clearance. Note the placement of the optimized components. L1 is positioned outside the ground plane and C1 is sitting across the ground plane and the copper clearance area. C2 is optional as a component but it is recommended to include these pads in case they are needed.

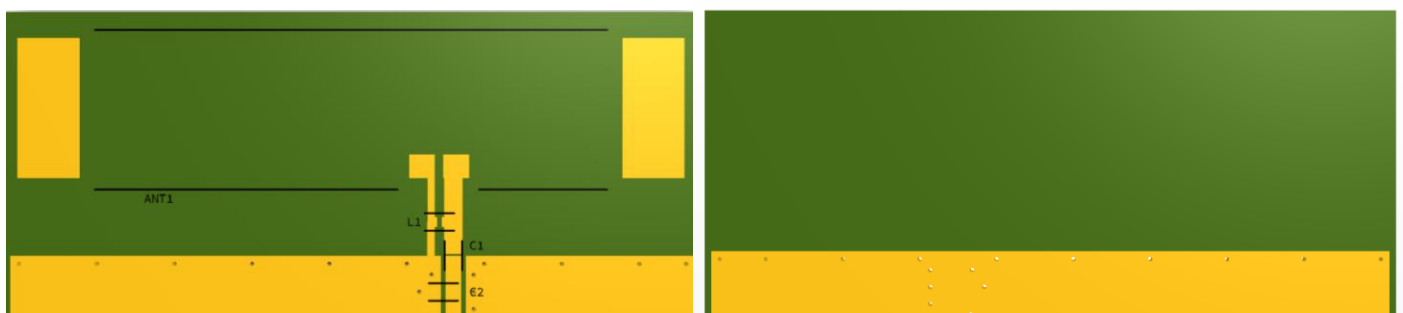

Topside

Bottom Side

6.4 PCB Clearance

Below shows the antenna footprint and clearance through ALL layers on the PCB. Only the antenna pads and connections to feed and GND are present within this clearance area (marked RED). The clearance area extends to 5mm from the antenna mechanical pads to the ground area. This clearance area includes the bottom side and ALL internal layers on the PCB.

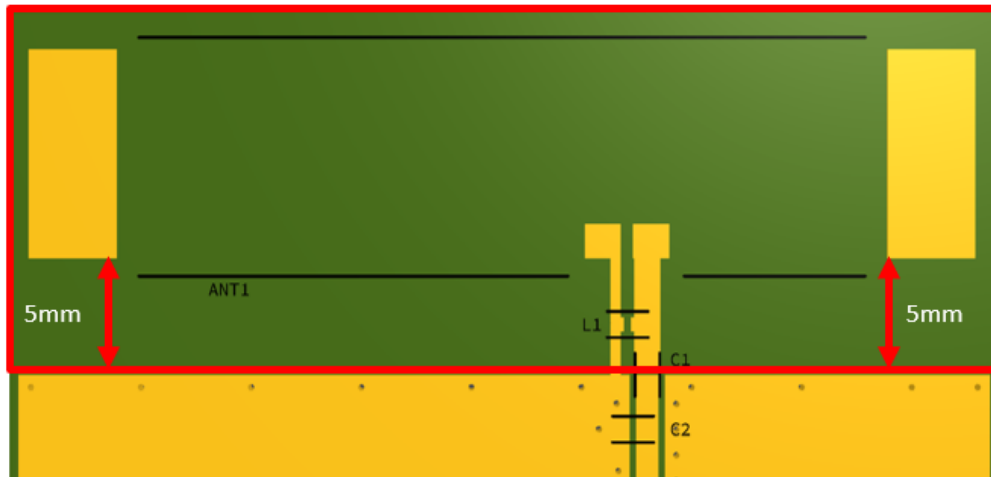

Topside

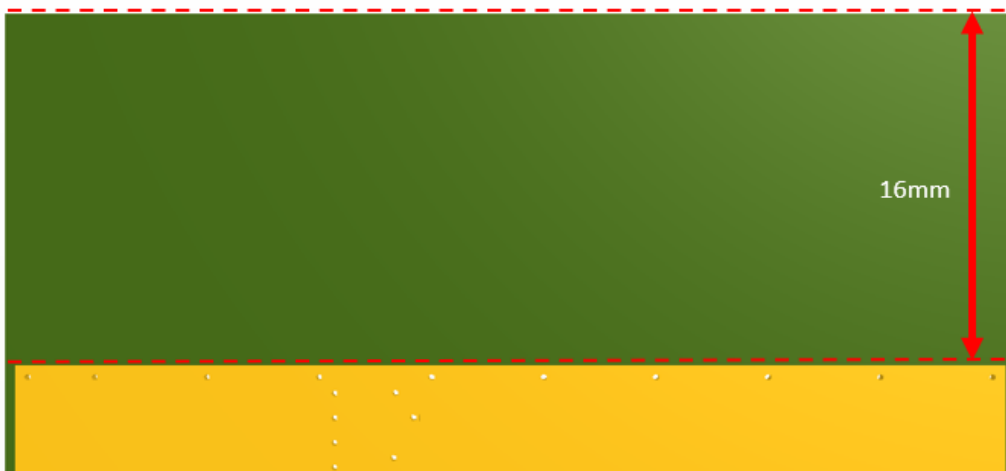

Bottom Side

6.5 Evaluation Board



Topside

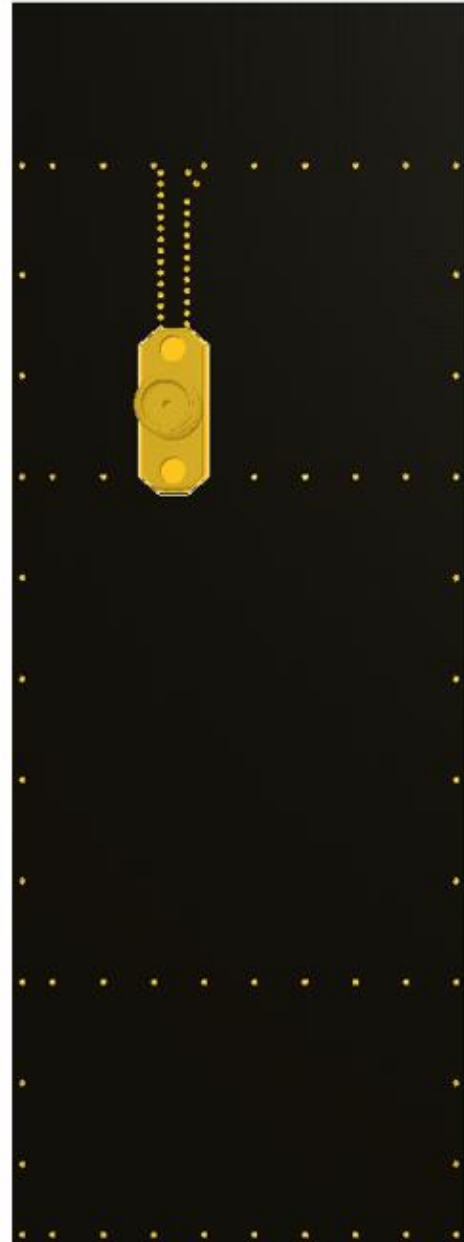

Bottomside

6.6 Evaluation Board Ground Plane Length

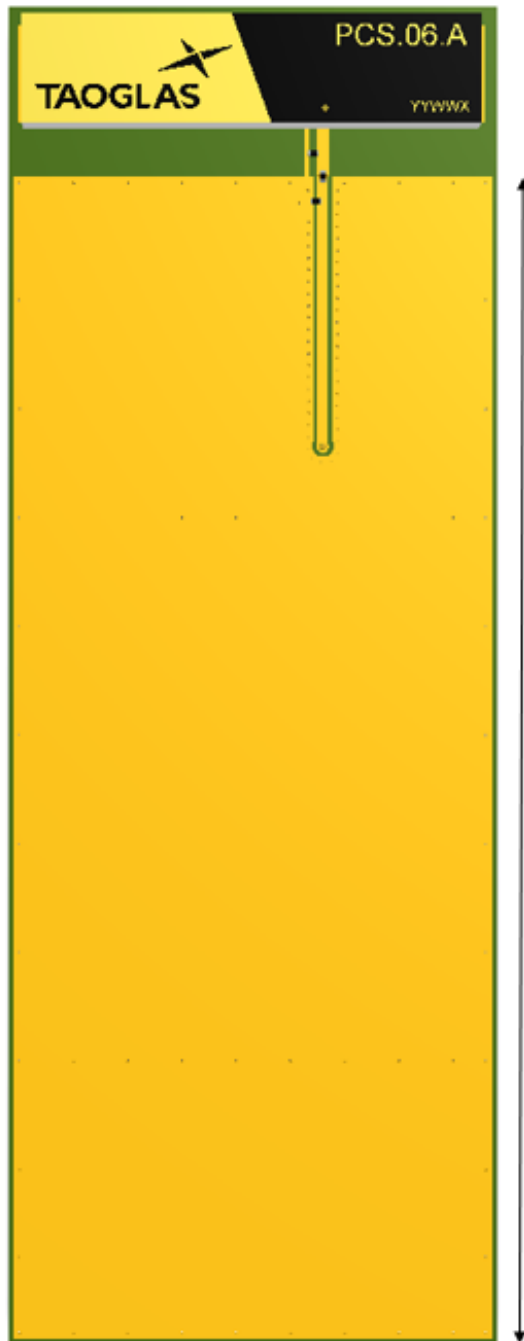

Ground Plane Length: 107mm

6.7 Evaluation Board Matching Circuit

A matching component (L1) in parallel with the PCS.06.A is required for the antenna to have optimal performance on the evaluation board, located outside of the ground plane in the space specified in the above images. C1 is also required as a matching component for this antenna. C1 is positioned sitting across the ground plane as shown in the above images. Additional matching components may be necessary for your device, so we recommend incorporating extra component footprints, forming a “pi” network, between the cellular module and the edge of the ground plane.

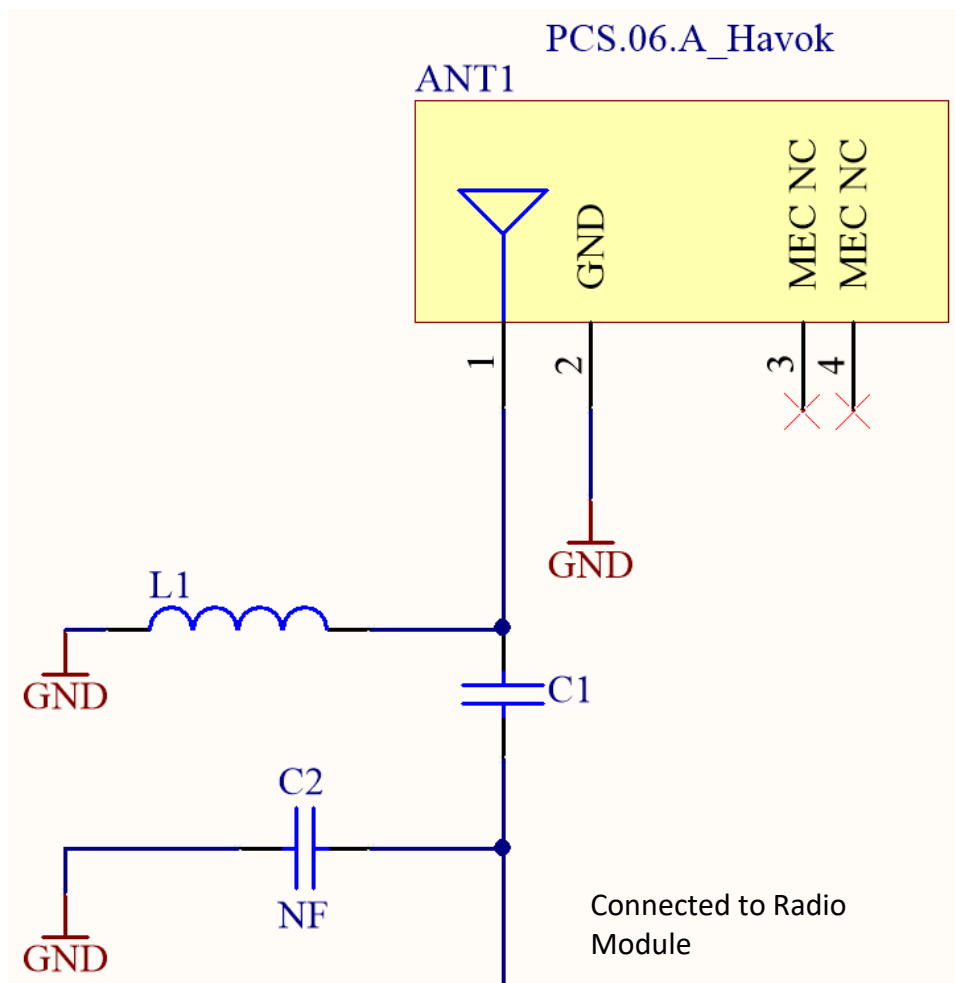

Designator	Type	Value	Description
L1	Inductor	6.8nH	TDK: MLK1005S Series
C1	Capacitor	6.8pF	Murata:GRM1555 Series
C2	Capacitor	Not Fitted	

6.8 Footprint

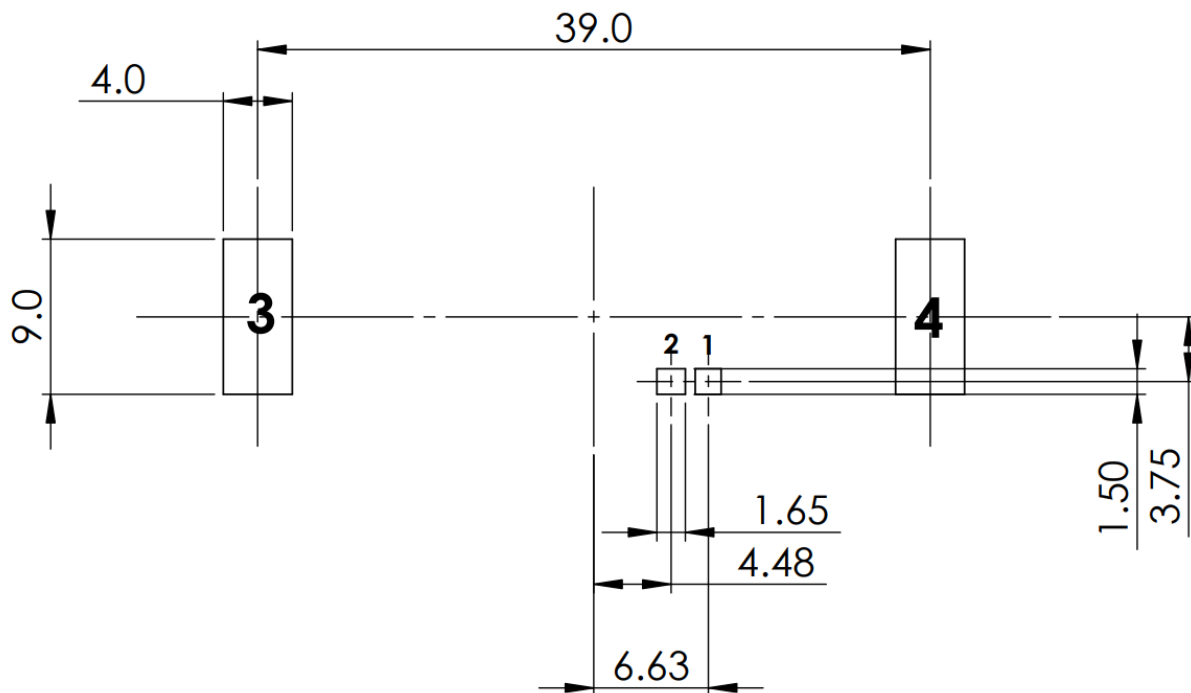

PCB FOOTPRINT

<u>PIN:</u>	<u>DESCRIPTION:</u>
1	Feed (50 ohm)
2,3,4	NC

7. Packaging

1000 pc PCS.06.A per reel
 Dimensions - Ø330*60mm
 Weight - 3230g

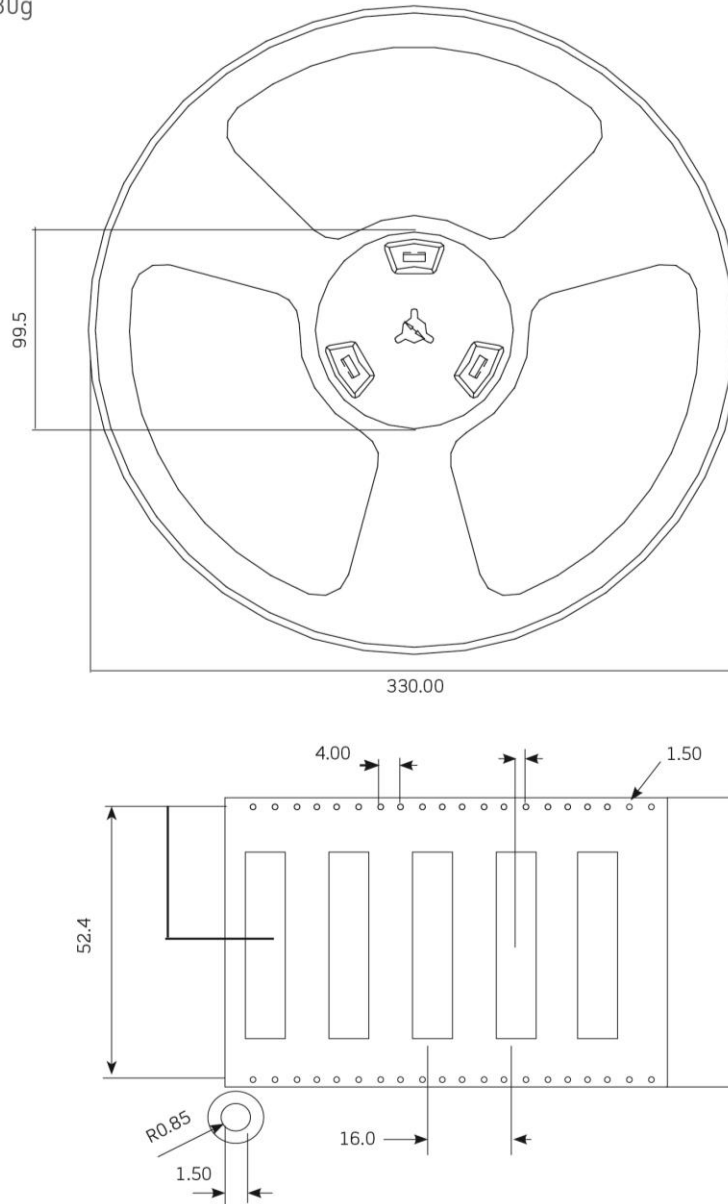

1000 pcs PCS.06.A reel
 Dimensions - 330*330*60mm
 Weight -3230g

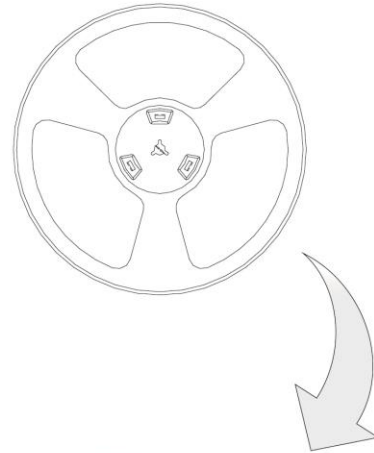

1000 pcs PCS.06.A / 1 Reel in small box
 Dimensions - 340*340*90mm
 Weight -3.5Kg

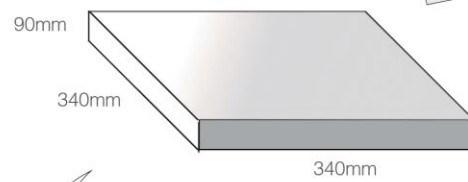

3 reels, 3000 pcs in one carton
 Carton Dimensions - 370*360*275mm
 Weight -11.3Kg

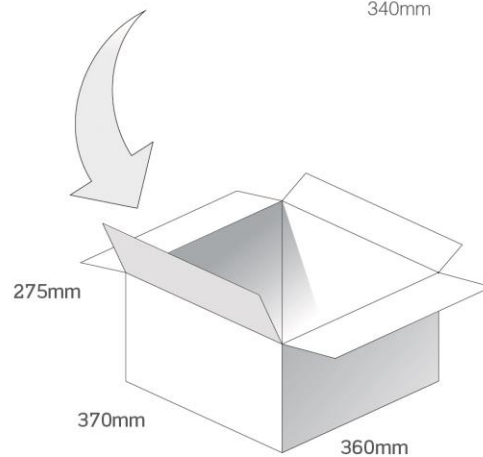

Pallet Dimensions 1200*1000*1320mm
 24 Cartons per Pallet
 6 Cartons per layer
 4 Layers

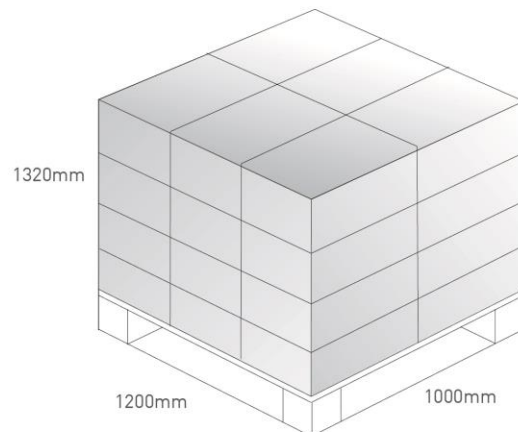

Changelog for the datasheet

SPE-13-8-070 – PCS.06.A

Revision: O (Current Version)

Date:	2021-02-22
Changes:	Updated datasheet template and added antenna integration guide.
Changes Made by:	Gary West

Previous Revisions

Revision: N

Date:	2015-11-19
Changes:	Updated Imagery Reference ECR-18-8-259
Changes Made by:	Russell Meyler

Revision: I

Date:	2017-04-14
Changes:	Ammended Drawing
Changes Made by:	Jack Conroy

Revision: M

Date:	2018-10-23
Changes:	Did not have a description for the bottom pads, nor a diagram for connections. Amended
Changes Made by:	David Connolly

Revision: H

Date:	2017-04-04
Changes:	Added LTE Band Table.
Changes Made by:	Peter Monahan

Revision: L

Date:	2018-01-30
Changes:	PCN-17-8-181/A
Changes Made by:	Carol Faughnan

Revision: G

Date:	2017-03-03
Changes:	Updated to include disclaimer, revised packaging as per PCN and general cleaning.
Changes Made by:	Andy Mahoney

Revision: K

Date:	2017-06-09
Changes:	Updated with image as per Aliss' request.
Changes Made by:	Andy Mahoney

Revision: F

Date:	2015-04-26
Changes:	Comments from John
Changes Made by:	Aine Doyle

Revision: J

Date:	2017-04-28
Changes:	Added LTE Band Table.
Changes Made by:	Peter Monahan

Revision: E

Date:	2015-06-30
Changes:	Added Packaging
Changes Made by:	Aine Doyle

Revision: D	
Date:	2015-05-19
Changes:	Updated Footprint
Changes Made by:	Aine Doyle

Revision: C	
Date:	2014-03-02
Changes:	Added Product Name
Changes Made by:	Aine Doyle

Revision: B	
Date:	2014-01-16
Changes:	Added Photo
Changes Made by:	Aine Doyle

Revision: A (First Release)	
Date:	
Changes:	First Release
Changes Made by:	Y



TAOGLAS®

www.taoglas.com

