

INTERMEDIATE ADJUSTABLE HAND CRIMP TOOL MH860 (M22520/7-01)



THIS HAND TOOL MUST NOT BE USED IN ANY POWERED "PRESS" AS DEFINED BY OSHA CFR 1910.211 (46)

SEE REVERSE SIDE FOR IMPORTANT INFORMATION CONCERNING LIMITED WARRANTY, AND LIMITATION OF LIABILITY.

HOW TO USE DANIELS MH860 (M22520/7-01) BASIC HAND CRIMP TOOL AND RELATED POSITIONERS

GENERAL INFORMATION

1. Designation MH860 (M22520/7-01) refers to basic hand tool without positioners: for wire barrel sizes 16, 20, and 22.
2. The tool has a double action ratchet. Note that the tool cannot be opened without completing the cycle.

TOOL PREPARATION

1. Tool must be in open position.
2. Remove safety clip from positioner guide.
3. Select Positioner for contact to be crimped.
4. Insert Positioner into positioner guide and turn 90 degrees until bayonet pins lock.
5. Install safety clip into positioner guide (optional).
6. Wire size and corresponding selector number are shown on data plate.
7. With tool still in open position, raise and rotate selector knob until number indicated on data plate for wire size to be crimped is in line with Sel. No. arrow.

CRIMPING INSTRUCTIONS

1. Insert contact and prepared wire into indenter opening from side opposite the Positioner.
2. Squeeze handles together until ratchet releases. Handle will return to the open position. Remove crimped contact and wire.

REMOVING POSITIONER

1. Remove safety clip and reverse procedure described in step four (4) above.

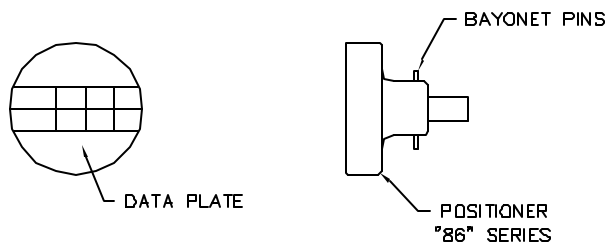
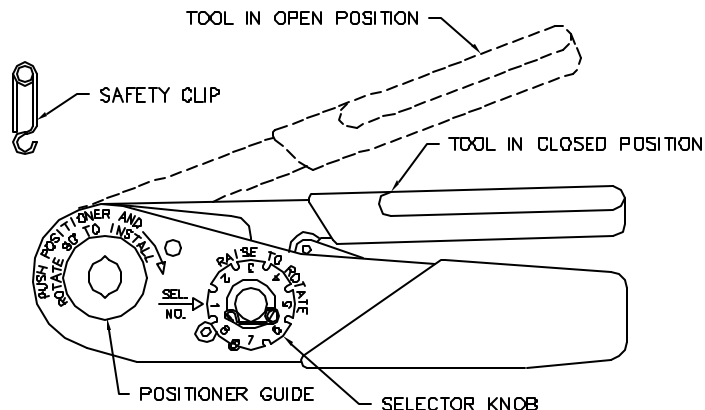

GAGE PART NO.	A GO DIA	B NO-GO DIA	SEL NO
G145	.0410	.0460	8

CAUTION!
DO NOT CRIMP GAGE!

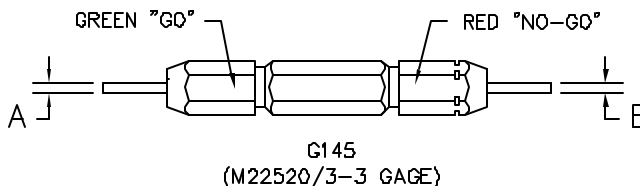

GAGING LIMITS

SELECTOR NUMBER	A ±.0001 GO DIA	B ±.0001 NO-GO DIA
1	.0160	.0210
2	.0190	.0240
3	.0220	.0270
4	.0250	.0300
5	.0290	.0340
6	.0330	.0380
7	.0370	.0420
B	.0410	.0460

GAGING INSTRUCTIONS

"GO" GAGING

Operate tool to fully closed position. Maintain firm hand pressure on the tool handles. Insert "GO" gage end as shown. Gage must pass freely between indenter tips.

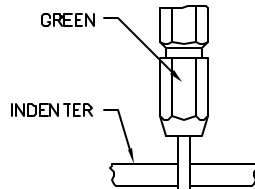

"NO-GO" GAGING

Operate tool to fully closed position. Maintain firm hand pressure on the tool handles. Insert "NO-GO" gage end as shown. The "NO-GO" gage may partially enter the indenter opening, but must not pass completely through the opening.

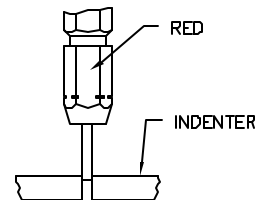

CARE OF TOOL

There is virtually no maintenance required. However, it is a good practice to keep indenter tips free of residual color band deposits and other debris. A small wire brush may be used for this purpose.

We strongly recommend that you:

1. DO NOT immerse tool in cleaning solution.
2. DO NOT spray oil into tool to lubricate.
3. DO NOT attempt to disassemble tool or make repairs.

This is a precision crimp tool and should be handled as such.

DMC offers complete refurbishing and recalibration services.

DMC specially engineers and manufactures complete tool kits to satisfy individual customer requirements, such as total aircraft support, general shop maintenance or production, on board ship and vehicle service, etc.

LIMITATION OF LIABILITY

DANIELS MANUFACTURING CORPORATION IS NOT LIABLE FOR CONSEQUENTIAL OR SPECIAL DAMAGES OF ANY NATURE OR KIND RESULTING FROM THE USE, OR MISUSE, OF ANY OF ITS PRODUCTS. OWNERS AND USERS OF DMC PRODUCTS ASSUME FULL RESPONSIBILITY FOR INSTRUCTING THEIR EMPLOYEES IN THE PROPER AND SAFE USE OF SUCH PRODUCTS.

LIMITED WARRANTY

DMC (Daniels Manufacturing Corporation) warrants each new product sold by it to be free from defects in material and workmanship under normal use and service. DMC's obligation under this warranty is limited to the free correction or, at DMC's option, the refund of the purchase price of any such product which proves defective in normal service within ninety (90) days after delivery to the first user, provided that the product is returned to DMC with all transportation charges prepaid and which shall appear to DMC's satisfaction, after DMC's inspection, to have been defective in material or workmanship, it being understood that DMC products are not consumer products. This warranty shall not cover any damage to any product which, in the opinion of DMC, was caused by normal wear, misuse, improper operation, tampering, neglect or accident. This warranty is in lieu of all other warranties express or implied. No warranty, express or implied, is made or authorized to be made or assumed with respect to products of Daniels Manufacturing Corporation other than those herein set forth.

REVISIONS				
REV. SYM.	E.C.O. NUMBER	DESCRIPTION	BY DATE	APP'D DATE
4		ADDED NOTE 1	JWJ 7-24-07	RRR 7-24-07

**UNCONTROLLED DOCUMENT
WILL NOT BE UPDATED**

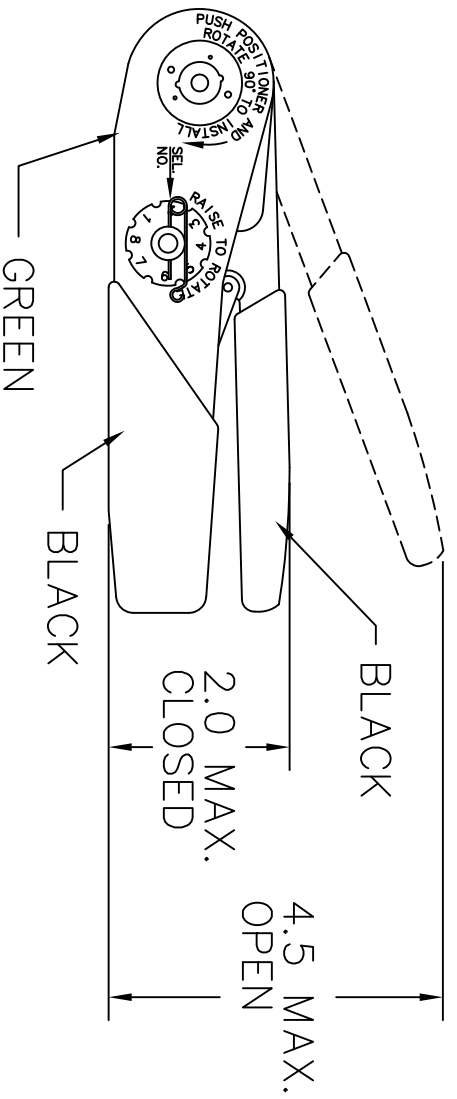
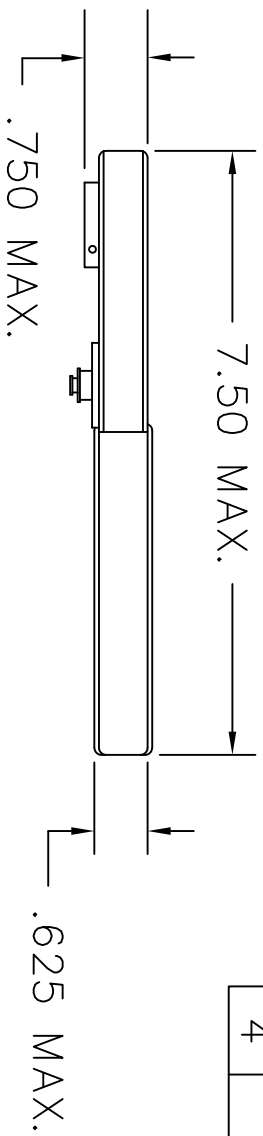

GAGING LIMITS OF INDENTERS			
SEL NO	INSPECTION GAGE		NO-GO
	GO	NO-GO	
1	±.0001	±.0001	
2	.0160	.0210	
3	.0190	.0240	
4	.0220	.0270	
5	.0250	.0300	
6	.0290	.0340	
7	.0330	.0380	
8	.0370	.0420	
	.0410	.0460	

USE GAGE G145 AT SEL. NO. 8

RESTRICTED & CONFIDENTIAL		ITEM	PART NO.	QTY.	DESCRIPTION/REMARKS
CONFIDENTIAL PROPERTY OF DANIELS MANUFACTURING CORP. NOT TO BE DISCLOSED TO OTHERS, REPRODUCED OR USED FOR ANY OTHER PURPOSE, EXCEPT AS AUTHORIZED IN WRITING BY DANIELS MANUFACTURING. MUST BE RETURNED TO DANIELS MANUFACTURING CORP. ON COMPLETION OF ORDER OR OTHER PURPOSE FOR WHICH LENT.		DRN.	DH	3-28-88	
		CHK'D.	ASM	3-28-88	
		APP'D.	AAM	3-28-88	
		APP'D.		DATE	
		NOTE: THIS DRAWING IS AN OUTLINE DRAWING OF THE RESPECTIVE DMC PART NUMBER INDICATED. ACTUAL DMC PART NUMBER IS DRAWING PART NUMBER WITHOUT THE "-ENV" SUFFIX.			
		WHERE USED: M22520/7-01			
		TITLE: ENVELOPE DRAWING CRIMPING TOOL			
		DMC DANIELS MANUFACTURING CORP. ORLANDO, FLORIDA CAGE 11851			
		SIZE SCALE CAD P/N SHEET OF A NTS MH860-ENV 1 1			
		POSTING DWG. NO. MH860-ENV REV. 4			
		DO NOT SCALE DRAWING			

1. USES "86" POSITIONERS.

NOTES: