

M12 FEMALE 0° CUBE67

PUR 2x0,5 GRAY, 1m

M12

Female straight

Cube67, 6-pole

Actuator supply external

2-pole used

Further cable lengths on request. Plastic housings with good resistance against chemicals and oils. The resistance to aggressive media should be individually tested for your application. Further details on request.

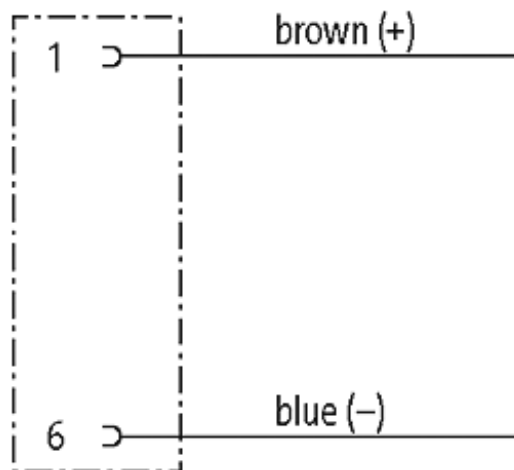
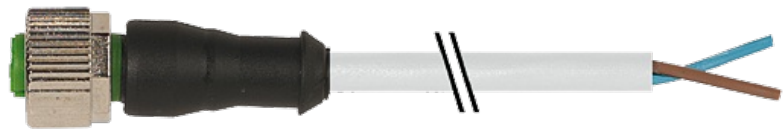
[Link to Product](#)**Illustration**

Female

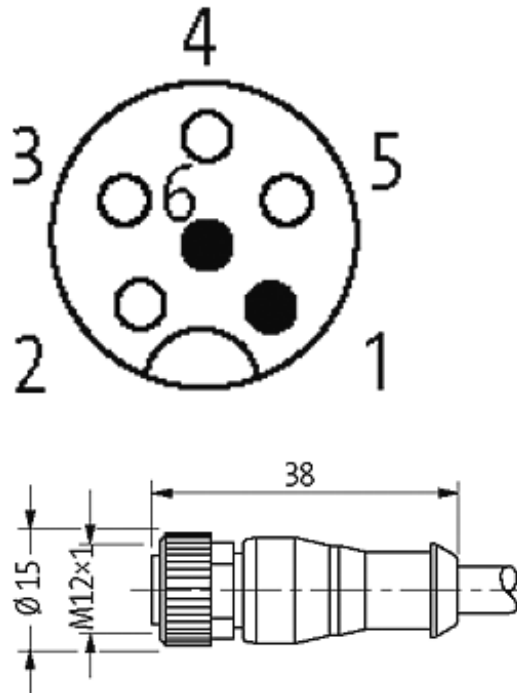

Product may differ from Image

Approvals



More Info

Cube67

Form

15001

Technical Data

Operating voltage	max. 30 V AC/DC
Operating current per contact	max. 4 A
Locking of ports	Screw thread M12 × 1 mm (recommended torque 0.6 Nm) self-securing
Protection	IP67 inserted and tightened (EN 60529)

Cables

Cable number	414
No./diameter of wires	2 × 0.5 mm ²
Wire isolation	PP (br, bl)
C-track properties	5 Mio.

The information in this brochure has been compiled with the utmost care.

Liability for the correctness completeness and topicality of the information is restricted to gross negligence. Version: 05/15

Torsion	2 Mio. \pm 180°/m
Jacket Color	gray
Shore hardness outer jacket	90 \pm 5A
Material (jacket)	PUR (UL/CSA)
Outer diameter	approx. 4.4 mm
Bend radius (fixed)	5 \times outer \varnothing
Bend radius (moving)	10 \times outer \varnothing
Temperature range (fixed)	-40...+80 °C
Temperature range (mobile)	-25...+80 °C

Commercial data

country of origin	DE
customs tariff number	85444290
minimum order quantity	1