



CIRCUIT-BREAKER SZ S0, FOR MOTOR PROTECTION, CLASS 10, A-RELEASE 18...25A, N-RELEASE 325A, SPRING-L. CONNECTION, STANDARD SW. CAPACITY, W. TRANSVERSE AUX. SWITCH 1NO+1NC

product brand name		SIRIUS
Product designation		3RV2 circuit breaker

General technical data:		
Active power loss total typical	W	8
Insulation voltage		
• with degree of pollution 3 Rated value	V	690
Shock resistance		
• acc. to IEC 60068-2-27		25g / 11 ms
Surge voltage resistance Rated value	kV	6
Mechanical service life (switching cycles)		
• of the main contacts typical		100 000
• of the auxiliary contacts typical		100 000
Electrical endurance (switching cycles)		
• typical		100 000
Temperature compensation	°C	-20 ... +60
Size of contactor can be combined company-specific		S00
Protection class IP		
• on the front		IP20
• of the terminal		IP20
Type of protection		Increased safety
Equipment marking		
• acc. to DIN EN 81346-2		Q

Main circuit:		
Number of poles for main current circuit		3

Adjustable response value current of the current-dependent overload release	A	18 ... 25
Operating voltage		
• Rated value	V	690
• at AC-3 Rated value maximum	V	690
Operating frequency Rated value	Hz	50 ... 60
Operating current Rated value	A	25
Operating current		
• at AC-3		
— at 400 V Rated value	A	25
Operating power		
• at AC-3		
— at 230 V Rated value	W	5 500
— at 400 V Rated value	W	11 000
— at 500 V Rated value	W	15 000
— at 690 V Rated value	W	22 000
Operating frequency		
• at AC-3 maximum	1/h	15

Auxiliary circuit:

Number of NC contacts		
• for auxiliary contacts		1
Number of NO contacts		
• for auxiliary contacts		1
Number of CO contacts		
• for auxiliary contacts		0
Product expansion Auxiliary switch		Yes
Design of the auxiliary switch		transverse
Operating current of the auxiliary contacts at AC-15		
• at 24 V	A	2
• at 120 V	A	0.5
• at 125 V	A	0.5
• at 230 V	A	0.5
Operating current of the auxiliary contacts at DC-13		
• at 24 V	A	1
• at 60 V	A	0.15

Protective and monitoring functions:

Trip class		CLASS 10
Design of the overload circuit breaker		thermal
Operational short-circuit current breaking capacity (Ics) with AC		
• at 240 V Rated value	kA	100
• at 400 V Rated value	kA	25

<ul style="list-style-type: none"> • at 500 V Rated value • at 690 V Rated value 	kA	5
	kA	2
Maximum short-circuit current breaking capacity (Icu)		
<ul style="list-style-type: none"> • with AC at 240 V Rated value • with AC at 400 V Rated value • with AC at 500 V Rated value • with AC at 690 V Rated value 	kA	100
	kA	55
	kA	10
	kA	4
Breaking capacity short-circuit current (Icn)		
<ul style="list-style-type: none"> • with 1 current path for DC at 150 V Rated value • with 2 current paths in series for DC at 300 V Rated value • with 3 current paths in series for DC at 450 V Rated value 	kA	10
	kA	10
	kA	10
Response value current of the instantaneous short-circuit release	A	325

UL/CSA ratings:

Full-load current (FLA) for three-phase AC motor		
<ul style="list-style-type: none"> • at 480 V Rated value • at 600 V Rated value 	A	25
	A	25
yielded mechanical performance [hp]		
<ul style="list-style-type: none"> • for single-phase AC motor at 110/120 V Rated value • for single-phase AC motor at 230 V Rated value • for three-phase AC motor at 200/208 V Rated value • for three-phase AC motor at 220/230 V Rated value • for three-phase AC motor at 460/480 V Rated value 	metric hp	2
	metric hp	3
	metric hp	5
	metric hp	7.5
	metric hp	15
Contact rating of the auxiliary contacts acc. to UL		C300 / R300

Short-circuit:

Product function Short circuit protection		Yes
Design of the short-circuit trip		magnetic
Design of the fuse link		
<ul style="list-style-type: none"> • for short-circuit protection of the auxiliary switch required 		Fuse gL/gG: 10 A, miniature circuit breaker C 6 A (short-circuit current I _k < 400 A)
Design of the fuse link for IT network for short-circuit protection of the main circuit		
<ul style="list-style-type: none"> • at 400 V • at 500 V • at 690 V 		gL/gG 63 A gL/gG 50 A gL/gG 50 A

Installation/ mounting/ dimensions:

mounting position		any
Mounting type		screw and snap-on mounting onto 35 mm standard mounting rail according to DIN EN 60715
Height	mm	119
Width	mm	45
Depth	mm	96
Required spacing		
<ul style="list-style-type: none"> • with side-by-side mounting <ul style="list-style-type: none"> — forwards — Backwards — upwards — downwards — at the side • for grounded parts <ul style="list-style-type: none"> — forwards — Backwards — upwards — at the side — downwards • for live parts <ul style="list-style-type: none"> — forwards — Backwards — upwards — downwards — at the side 	mm	0 0 50 50 0 0 0 50 30 50 0 0 50 50 30

Connections/ Terminals:

Type of electrical connection		
<ul style="list-style-type: none"> • for main current circuit • for auxiliary and control current circuit 		spring-loaded terminals spring-loaded terminals
Arrangement of electrical connectors for main current circuit		Top and bottom
Product function		No
<ul style="list-style-type: none"> • removable terminal for auxiliary and control circuit 		
Type of connectable conductor cross-section		
<ul style="list-style-type: none"> • for main contacts <ul style="list-style-type: none"> — single or multi-stranded — finely stranded with core end processing — finely stranded without core end processing • for AWG conductors for main contacts 		2x (1 ... 10 mm ²) 2x (1 ... 6 mm ²) 2x (1 ... 6 mm ²) 2x (18 ... 8)

<ul style="list-style-type: none"> • for auxiliary contacts <ul style="list-style-type: none"> — single or multi-stranded — finely stranded with core end processing — finely stranded without core end processing • for AWG conductors for auxiliary contacts 		2x (0,5 ... 2,5 mm ²) 2x (0.5 ... 1.5 mm ²) 2x (0.5 ... 1.5 mm ²) 2x (20 ... 14)
Design of screwdriver shaft		Diameter 5 to 6 mm

Safety related data:

B10 value with high demand rate acc. to SN 31920		50 000
Proportion of dangerous failures		
<ul style="list-style-type: none"> • with low demand rate acc. to SN 31920 • with high demand rate acc. to SN 31920 	%	40
	%	40
Failure rate [FIT] with low demand rate acc. to SN 31920	FIT	50
T1 value for proof test interval or service life acc. to IEC 61508	y	10
Protection against electrical shock		finger-safe

Mechanical data:

Size of the circuit-breaker		S0
------------------------------------	--	----

Ambient conditions:





Installation altitude at height above sea level maximum	m	2 000
Ambient temperature		
<ul style="list-style-type: none"> • during operation • during storage • during transport 	°C	-20 ... +60
	°C	-50 ... +80
	°C	-50 ... +80
Relative humidity during operation	%	10 ... 95





Display:

Display version		
<ul style="list-style-type: none"> • for switching status 		Handle

Certificates/ approvals:

General Product Approval				Declaration of Conformity	Test Certificates
 CCC	 CSA	 UL		 EG-Konf.	Declaration of the Compliance with the order

Test Certificates		Shipping Approval			
Special Test Certificate	Type Test Certificates/Test Report	 ABS	 BUREAU VERITAS	 DNV	 GL

Shipping Approval				other	
 LRS	 PRS	 RINA	 RMRS	Confirmation	Environmental Confirmations

other	
 VDE	other

Further information

Information- and Downloadcenter (Catalogs, Brochures,...)

<http://www.siemens.com/industrial-controls/catalogs>

Industry Mall (Online ordering system)

<http://www.siemens.com/industrymall>

Cax online generator

<http://support.automation.siemens.com/WW/CAXorder/default.aspx?lang=en&mlfb=3RV20214DA25>

Service&Support (Manuals, Certificates, Characteristics, FAQs,...)

<http://support.automation.siemens.com/WW/view/en/3RV20214DA25/all>

Image database (product images, 2D dimension drawings, 3D models, device circuit diagrams, EPLAN macros, ...)

http://www.automation.siemens.com/bilddb/cax_de.aspx?mlfb=3RV20214DA25&lang=en

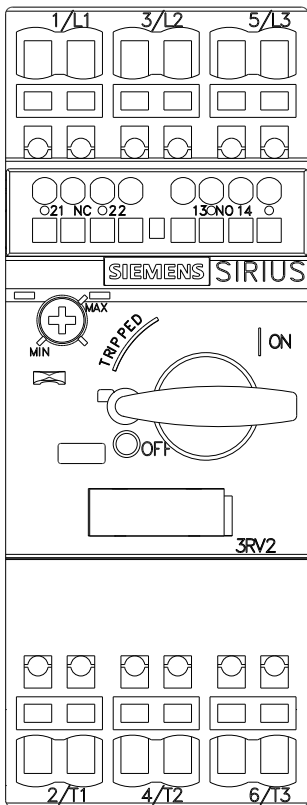
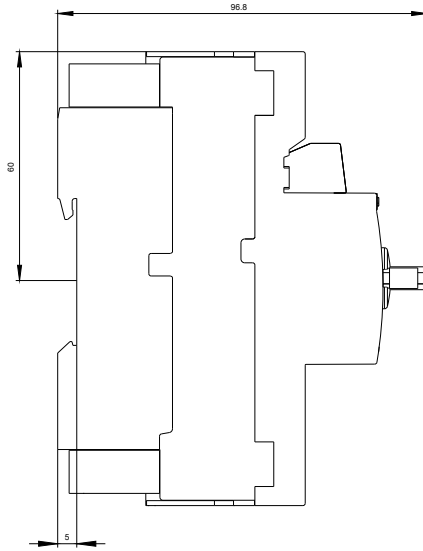
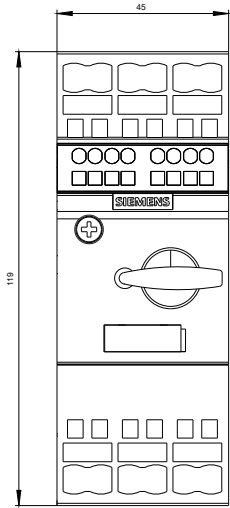

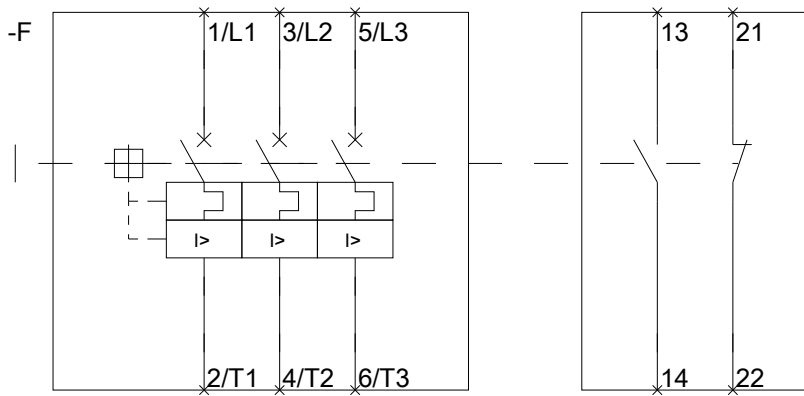

last modified:

11.03.2015